

**FRANKY SLIM**

The Franky Slim is fully upholstered over high resiliency foam on a solid hardwood frame featuring square steel tube or solid wood legs. Designed for student housing and any public spaces that require long duration seating comfort.



FRANKY SLIM ARM CHAIR  
WOOD LEGS - OPTIONAL WOOD ARM CAPS



FRANKY SLIM OTTOMAN



TWO SEAT FRANKY SLIM LOUNGE  
SQUARE TUFTING

**ORDERING INFORMATION**

- 1) Series Name
- 2) Model Number
- 3) Quantity
- 4) Fabric Grade and Number
- 5) Leg Finish
- 6) Optional Tufting
- 7) Optional Items

**FRANKY SLIM LOUNGE SPECIFICATIONS**

**Frame**

Frame assembly is constructed of solid hardwood, and multi-ply hardwood, with tongue and groove construction. No sag-springs are installed in seat & back along with interlocking helicoil springs to prevent sagging and provide additional lower back and seat support.

**Upholstery**

Seat foam is bonded to all sides of hardwood frame. Seat cushions are 4" graded, high resiliency (H.R.) block foam with seat back 3" H.R. foam, covered entirely with special bonded polyester fiber to protect final upholstery. ERG uses only water-based glues and adhesives in all our upholstery process.

**Arm Caps**

Wood arm caps are optional on Franky wood leg models.

**Tufting**

Square, vertical & diagonal tufting options available for lounges, ottomans and benches.

**Legs**

1" square tubular steel legs are available in over 20 standard epoxy powder coat colors or optional polished chrome. Wood legs are 2" square solid maple and are available in all standard wood stain colors.

**Warranty**

ERG offers a lifetime warranty on all foam and frames.

**COLORS / FINISHES**

**Leg Finish Colors:**

Standard powder coat color choices, optional polished chrome or wood stain colors.

**OPTIONS**

- CODE: FR - CAL 133 (TB 133) Fire Retardant option.
- CODE: MB - Moisture Barrier on seat.
- CODE: PCL - Polished Chrome Legs.
- CODE: TF1 - Single Seat Tufting.
- CODE: TF2 - Two Seat Tufting.
- CODE: TF3 - Three Seat Tufting.
- CODE: TFO - Ottoman Tufting.
- CODE: PCL - Polished Chrome Legs.
- CODE: WAC - Wood Arm Caps.

Note: Factory installed power/data available, see accessories section for details and pricing.

SOFT SEATING	WEIGHT LIMIT
1 Seat	500 lbs.
2 Seat	1000 lbs.
3 Seat	1500 lbs.



METAL LEGS



WOOD LEGS

**TUFTING OPTIONS**

---

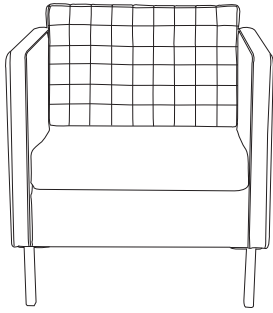

square



with optional tufting

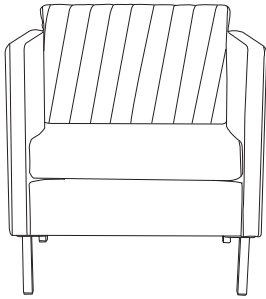

diagonal



with optional tufting

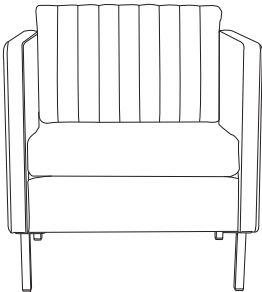

vertical



with optional tufting

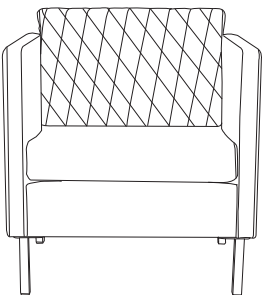

diamond



with optional tufting

---

**TUFTING**

**Choose from 4 Tufting Shapes:**

Tufting for all lounge, ottoman and bench series are available in 4 designs.  
Please specify Square, Vertical, Diamond or Diagonal when ordering.

**FRANKY SLIM LOUNGE**  
**ARM CHAIR AND LOUNGE SOFAS**  
**METAL LEGS**

DIMENSIONS	Single Seat	Two Seat	Three Seat
Seat Depth:	21"	21"	21"
Seat Height:	18"	18"	18"
Seat Width:	23"	46.5"	70"
Arm Height:	28"	28"	28"
Overall Depth:	30.5"	30.5"	30.5"
Overall Width:	28.5"	52"	75.5"
Overall Height:	32"	32"	32"
Qty./Wt.:	1 ea./75 lbs.	1 ea./95 lbs.	1 ea./120 lbs.



FRANKY SLIM LOUNGE



TWO SEAT FRANKY SLIM LOUNGE  
SQUARE TUFTING OPTION

**MODEL / DESCRIPTION / LIST PRICING**



**6420-M Single Seat Lounge**

COM Yardage: Arms 3 Yds. pair / Frame: 1 Yd. / Seat/Back Pillow: 2.5 Yds.

COM	GR1	GR2	GR3	GR4	GR5	GR6	GR7	GR8	GR9	GR10	LEA
\$1830	\$1958	\$2036	\$2118	\$2203	\$2291	\$2383	\$2478	\$2577	\$2680	\$2787	\$3294



**6422-M Two Seat Lounge**

COM Yardage: Arms 3 Yds. pair / Frame: 1.5 Yds. / Seat/Back Pillow: 5 Yds.

COM	GR1	GR2	GR3	GR4	GR5	GR6	GR7	GR8	GR9	GR10	LEA
\$2463	\$2636	\$2740	\$2850	\$2965	\$3083	\$3207	\$3334	\$3468	\$3607	\$3751	\$4433

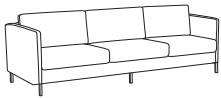

**6424-M Three Seat Lounge (6 legs)**

COM Yardage: Arms 3 Yds. pair / Frame: 2 Yds. / Seat/Back Pillow: 7.5 Yds.

COM	GR1	GR2	GR3	GR4	GR5	GR6	GR7	GR8	GR9	GR10	LEA
\$3220	\$3444	\$3583	\$3726	\$3875	\$4030	\$4191	\$4359	\$4533	\$4714	\$4903	\$5796

**TUFTING**

**Choose from 4 Tufting Shapes:**

Tufting for all lounge, ottoman and bench series are available in 4 designs. Please specify Square, Vertical, Diagonal or Diamond when ordering.

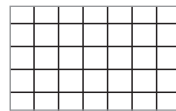

square



vertical

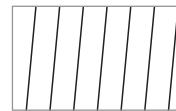

diagonal



diamond

**OPTIONS**

Add upcharge to list price and code to model number

FR	CAL 133 (TB 133) Fire Retardant per yard	\$90/yd.
MB	Moisture Barrier - per seat	\$125
2FO	Two fabric option	\$98
PCL	Polished Chrome Leg	\$17 per leg

TF1	Tufting - single seat	\$189
TF2	Tufting - two seat	\$340
TF3	Tufting - three seat	\$486

**FRANKY SLIM LOUNGE  
ARM CHAIR AND LOUNGE SOFAS  
WOOD LEGS**

DIMENSIONS	Single Seat	Two Seat	Three Seat
Seat Depth:	21"	21"	21"
Seat Height:	18"	18"	18"
Seat Width:	23"	46.5"	70"
Arm Height:	28"	28"	28"
Overall Depth:	30.5"	30.5"	30.5"
Overall Width:	28.5"	52"	75.5"
Overall Height:	32"	32"	32"
Qty./Wt.:	1 ea./75 lbs.	1 ea./95 lbs.	1 ea./120 lbs.



FRANKY SLIM ARM CHAIR  
WOOD LEGS - OPTIONAL WOOD ARM CAPS



TWO SEAT FRANKY SLIM LOUNGE  
WOOD LEGS - OPTIONAL WOOD ARM CAPS

**MODEL / DESCRIPTION / LIST PRICING**



**6420-W Single Seat Lounge**

COM Yardage: Arms 3 Yds. pair / Frame: 1 Yd. / Seat/Back Pillow: 2.5 Yds.

COM	GR1	GR2	GR3	GR4	GR5	GR6	GR7	GR8	GR9	GR10	LEA
\$2000	\$2141	\$2226	\$2315	\$2408	\$2504	\$2604	\$2709	\$2817	\$2930	\$3047	\$3601

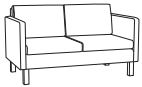

**6422-W Two Seat Lounge**

COM Yardage: Arms 3 Yds. pair / Frame: 1.5 Yds. / Seat/Back Pillow: 5 Yds.

COM	GR1	GR2	GR3	GR4	GR5	GR6	GR7	GR8	GR9	GR10	LEA
\$2657	\$2844	\$2957	\$3076	\$3199	\$3327	\$3460	\$3598	\$3742	\$3891	\$4047	\$4784

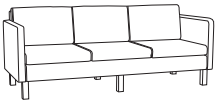

**6424-W Three Seat Lounge**

COM Yardage: Arms 3 Yds. pair / Frame: 2 Yds. / Seat/Back Pillow: 7.5 Yds.

COM	GR1	GR2	GR3	GR4	GR5	GR6	GR7	GR8	GR9	GR10	LEA
\$3279	\$3520	\$3668	\$3820	\$3980	\$4146	\$4319	\$4497	\$4684	\$4878	\$5079	\$6033

**TUFTING**

**Choose from 4 Tufting Shapes:**

Tufting for all lounge, ottoman and bench series are available in 4 designs. Please specify Square, Vertical, Diamond or Diagonal when ordering.

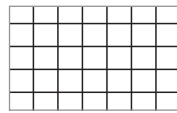

square

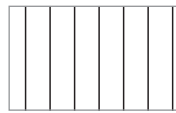

vertical

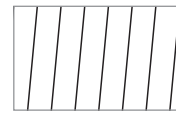

diagonal

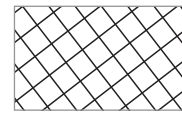

diamond

**OPTIONS**

Add upcharge to list price and code to model number

FR	CAL 133 (TB 133) Fire Retardant per yard	\$90/yd.
MB	Moisture Barrier - per seat	\$125
2FO	Two fabric option	\$98
PCL	Polished Chrome Leg	\$17 per leg

TF1	Tufting - single seat	\$189
TF2	Tufting - two seat	\$340
TF3	Tufting - three seat	\$486
WAC	Wood Arm Caps	\$75 each

**FRANKY SLIM**

The Franky Slim metal bench and ottoman is fully upholstered over high resiliency foam on a solid steel frame featuring square steel tube legs. Designed for student housing and any public spaces that require long duration seating comfort.



3 SEAT BENCH



FRANKY SLIM OTTOMAN

**ORDERING INFORMATION**

- |                            |                     |
|----------------------------|---------------------|
| 1) Series Name             | 5) Leg Finish       |
| 2) Model Number            | 6) Optional tufting |
| 3) Quantity                | 7) Optional Items   |
| 4) Fabric Grade and Number |                     |

**FRANKY SLIM LOUNGE SPECIFICATIONS**

**Steel Frame Construction**

- Built-in wall saver design.
- 1-1/4" square steel tubing, welded to steel apron.

**Upholstery**

Seat foam is bonded to all sides of hardwood frame. Seat cushions are 4" graded, high resiliency (H.R.) block foam with seat back 3" H.R. foam, covered entirely with special bonded polyester fiber to protect final upholstery. ERG uses only water-based glues and adhesives in all our upholstery process.

**Seat**

- Large webbing stretched over hardwood frame
- High resiliency foam applied and bonded

**Tufting**

Square, vertical & diagonal tufting options available for lounges, ottomans and benches.

**Legs**

1" square tubular steel legs are available in over 20 standard epoxy powder coat colors or optional polished chrome. Wood legs are 2" square solid maple and are available on ottoman only in all standard wood stain colors.

**Warranty**

ERG offers a lifetime warranty on all foam and frames.

**COLORS / FINISHES**

**Leg Finish Colors:**

- Metal:** Standard powder coat colors, optional polished chrome
- Wood:** Standard wood stain colors

**OPTIONS**

- CODE: FR - CAL 133 (TB 133) Fire Retardant option. Add an additional \$90 per yard.
- CODE: MB - Moisture Barrier on seat.
- CODE: PCL - Polished Chrome Legs.
- CODE: TF2 - Two seat tufting.
- CODE: TF3 - Three seat tufting.
- CODE: TFO - Ottoman tufting.

Note: Factory installed power/data available, see accessories section for details and pricing.



METAL LEGS

**OTTOMAN & BENCHES TUFTING OPTIONS**

---

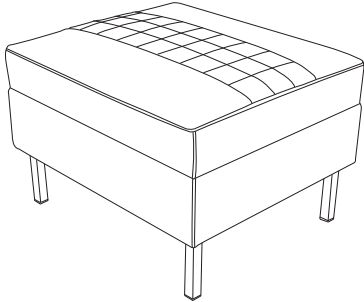

square



with optional tufting

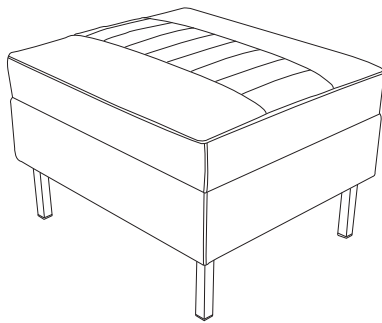

vertical



with optional tufting

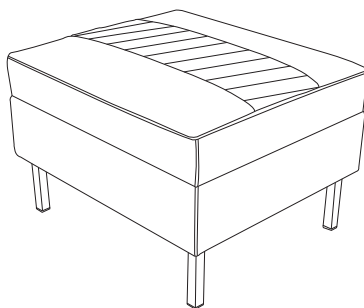

diagonal



with optional tufting

DIMENSIONS	Ottoman	2-Seat Bench	3-Seat Bench
Overall Depth:	20"	20"	20"
Overall Width:	22"	42"	60"
Overall Height:	16"	18"	18"
Qty./Wt. per carton:	1 ea./35 lbs.	1 ea./55 lbs.	1 ea./80 lbs.



OTTOMAN



3 SEAT BENCH

**MODEL / DESCRIPTION / LIST PRICING**

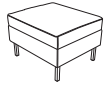

**6426-M Ottoman Metal Legs**

COM Yardage: 1.5 Yards.

COM	GR1	GR2	GR3	GR4	GR5	GR6	GR7	GR8	GR9	GR10	LEA
\$1110	\$1187	\$1235	\$1283	\$1335	\$1389	\$1444	\$1502	\$1562	\$1624	\$1690	\$1996



**6426-W Ottoman Wood Legs**

COM Yardage: 1.5 Yards.

COM	GR1	GR2	GR3	GR4	GR5	GR6	GR7	GR8	GR9	GR10	LEA
\$1175	\$1258	\$1308	\$1360	\$1415	\$1470	\$1530	\$1591	\$1655	\$1721	\$1790	\$2116



**6428-M 2 Seat Bench**

COM Yardage: 2 Yards.

COM	GR1	GR2	GR3	GR4	GR5	GR6	GR7	GR8	GR9	GR10	LEA
\$1710	\$1829	\$1902	\$1978	\$2057	\$2140	\$2225	\$2314	\$2407	\$2504	\$2604	\$3077

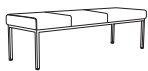

**6429-M 3 Seat Bench**

COM Yardage: 3 Yards.

COM	GR1	GR2	GR3	GR4	GR5	GR6	GR7	GR8	GR9	GR10	LEA
\$2235	\$2390	\$2485	\$2585	\$2689	\$2797	\$2908	\$3025	\$3146	\$3271	\$3402	\$4021

**TUFTING**

**Choose from 3 Tufting Shapes:**

Tufting for all lounge, ottoman and bench series are available in 3 designs. Please specify Square, Vertical or Diagonal when ordering.

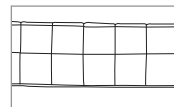

square

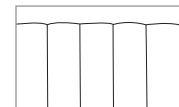

vertical

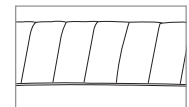

diagonal

**OPTIONS**

Add upcharge to list price and code to model number

FR	CAL 133 (TB 133) Fire Retardant per yard.	\$90/yd.
MB1	Moisture Barrier on seat - per seat	\$125
PCL	Polished chrome leg Ottoman	\$88
PCL	Polished chrome leg 2 Seat Bench	\$358

PCL	Polished chrome leg 3 Seat Bench	\$475
TFO	Ottoman tufting	\$156
TF2	Two seat bench tufting	\$280
TF3	Three seat bench tufting	\$374