



COMPLEMENTED WITH TRENO TABLES

LAGUNA TABLE OF CONTENTS

Laguna Specifications	2
Laguna Standard Back vs Inset Back	3
Laguna Banquettes Options	4
Laguna Banquettes Pricing	5
Laguna Banquettes Privacy Panels	6
Laguna Modular Options	7
Laguna Modular Pricing	9
Laguna Modular Privacy Panels	13
Laguna Modular Arms	17
Laguna Modular Quattro Pricing	21
Laguna Lounge Options	22
Laguna Lounge Pricing	23
Laguna Lounge Hideout Pricing	24
Laguna Bolster & Pillows	25
Laguna Bench Pricing	26
Laguna Ottomans Pricing	27
Laguna Tables	31
Laguna Configurations	35

LAGUNA COLLECTION

A very versatile lounge and modular system that will enhance any space or public environment. Laguna offers endless configurations with an array of options and finishes for a truly American visionary design.



BANQUETTES



MODULAR



MODULAR - QUATTRO



LOUNGE - HIDEOUT



LOUNGE



BENCH



OTTOMAN



OCCASIONAL TABLE

ORDERING INFORMATION

- 1) Series Name
- 2) Model Number
- 3) Quantity
- 4) Fabric Grade and Number
- 5) Powder Coat Color for legs
- 6) Optional Items
- 7) Optional Wood Stain Color

COLORS / FINISHES

Legs

- Standard powder coat colors.

STANDARD POWDERCOAT
METAL LEG



SPECIFICATIONS

Frame Construction

- Multi-ply hardwood
- Tongue and groove construction nailed and glued

Seat/Foam

- No-sag springs w/ helicoil attachment
- High resiliency foam construction throughout
- All foam bonded to frame

Upholstery

Seat and back are covered in choice of fabric, vinyl, crypton, leather or COM. ERG uses only water based glues and adhesives in our upholstery process.

Legs

- 8" tall, 1.5" diameter fabricated steel angled legs
- Sand blasted prior to paint for maximum color adhesion
- Includes factory installed adjustable glides

SOFT SEATING	WEIGHT LIMIT
1 Seat	500 lbs.
2 Seat	1000 lbs.
3 Seat	1500 lbs.

STANDARD BACK

OPTIONAL INSET BACK

BACK IS INSET 2" ON EACH SIDE



STRAIGHT UNIT

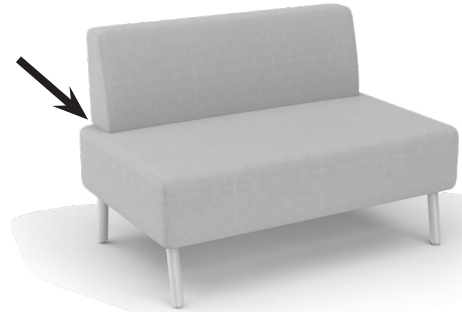

OUTSIDE CURVE



INSIDE CURVE



STRAIGHT PRIVACY
PANEL



OPTIONS

- CODE: FR - CAL 133 (TB 133) Fire Retardant
- CODE: MB - Moisture Barrier (up to 60" overall width)
- CODE: MB60 - Moisture Barrier (over 60" overall width)
- CODE: PC - Polished Chrome Legs
- CODE: WDL - Metal/Wood Legs. (Specify powder coat and wood color)
- CODE: WDL-C - Chrome/Wood Legs. (Specify wood color)
- CODE: 2FO - Two Fabric Option
- CODE: 3FO - Three Fabric Option
- CODE: GD - Ganging Device (Necessary when ganging two or more modules together)
- CODE: ISB - Inset Back

Note: Factory installed power/data available, see accessories online under the 'Products' tab.



SHOWN WITH 3FORM ACRYLIC PRIVACY PANEL, POWER/DATA AND METAL/WOOD LEGS

Laguna Leg Options



2 TONE FABRIC

OPTIONAL METAL/WOOD LEG
CODE: WDL



OPTIONAL CHROME LEG
CODE: PC



OPTIONAL CHROME/WOOD LEG
CODE: WDL-C



DIMENSIONS	48" Straight	60" Straight	72" Straight
Seat Depth:	21"	21"	21"
Seat Width:	48"	60"	72"
Seat Height:	18"	18"	18"
Overall Depth:	27"	27"	27"
Overall Width:	48"	60"	72"
Overall Height:	30"	30"	30"
Qty./Wt.:	1 ea./75 lbs.	1 ea./90 lbs.	1 ea./110 lbs.



60" W STRAIGHT UNIT

MODEL / DESCRIPTION / LIST PRICING



1206 48" W Straight (4 legs)

COM Yardage: Total: 5.25 Yds. / Back: 2.5 Yds. / Seat: 2.75 Yds.

COM	GR1	GR2	GR3	GR4	GR5	GR6	GR7	GR8	GR9	GR10	LEA
\$2243	\$2374	\$2505	\$2636	\$2766	\$2897	\$3028	\$3159	\$3290	\$3420	\$3551	\$3677



1208 60" W Straight (4 legs)

COM Yardage: Total: 6.5 Yds. / Back: 3 Yds. / Seat: 3.5 Yds.

COM	GR1	GR2	GR3	GR4	GR5	GR6	GR7	GR8	GR9	GR10	LEA
\$2910	\$3074	\$3205	\$3335	\$3466	\$3597	\$3728	\$3859	\$3989	\$4120	\$4251	\$4376

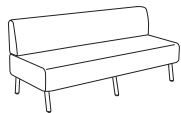

1210 72" W Straight (6 legs)

COM Yardage: Total: 7.5 Yds. / Back: 3.5 Yds. / Seat: 4 Yds.

COM	GR1	GR2	GR3	GR4	GR5	GR6	GR7	GR8	GR9	GR10	LEA
\$3257	\$3420	\$3551	\$3682	\$3813	\$3944	\$4074	\$4205	\$4336	\$4467	\$4598	\$4723

Note: For back-to-back applications please order two units.

OPTIONS

Add upcharge to list price and code to model number

FR	CAL 133 (TB 133) Fire Retardant per yard	\$90/yd.
MB	Moisture Barrier - up to 60" width	\$125 each
MB60	Moisture Barrier - over 60" width	\$200 each
WDL	Metal/Wood Legs	\$35 each
WDL-C	Chrome/Wood Legs	\$60 each

PC	Polished Chrome Legs	\$35 each
2FO	Two Fabric Option	\$98
GD	Ganging Device	\$52
ISB	Inset Back (Add to Standard Unit)	\$50

PRIVACY PANELS ONLY

DIMENSIONS	48" Wide Privacy Panel	60" Wide Privacy Panel	72" Wide Privacy Panel
Panel Depth:	1"	1"	1"
Panel Width:	48"	60"	72"
Panel Height:	48"	48"	48"
Qty./Approx Wt.:	1 ea./100 lbs.	1 ea./110 lbs.	1 ea./120 lbs.



1/2" THICK ACRYLIC
PRIVACY PANELS AVAILABLE

LAGUNA BANQUETTE
WITH PRIVACY PANEL

MODEL / DESCRIPTION / LIST PRICING

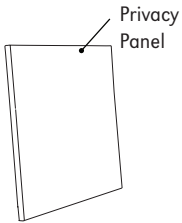

360P 48" W Privacy Panel

COM Yardage: Total: 3 Yds. (Please allow extra fabric for repeat design.)

COM	GR1	GR2	GR3	GR4	GR5	GR6	GR7	GR8	GR9	GR10	LEA
\$948	\$1015	\$1055	\$1098	\$1141	\$1187	\$1234	\$1283	\$1334	\$1389	\$1443	\$1706
LAMINATE			VENEER			ACRYLIC					
\$929			\$1827			CALL					

362P 60" W Privacy Panel

COM Yardage: Total: 4 Yds. (Please allow extra fabric for repeat design.)

COM	GR1	GR2	GR3	GR4	GR5	GR6	GR7	GR8	GR9	GR10	LEA
\$1250	\$1339	\$1391	\$1448	\$1505	\$1565	\$1627	\$1693	\$1760	\$1831	\$1904	\$2251
LAMINATE			VENEER			ACRYLIC					
\$1214			\$2350			CALL					

365P 72" W Privacy Panel

COM Yardage: Total: 5 Yds. (Please allow extra fabric for repeat design.)

COM	GR1	GR2	GR3	GR4	GR5	GR6	GR7	GR8	GR9	GR10	LEA
\$1531	\$1638	\$1704	\$1772	\$1843	\$1916	\$1993	\$2073	\$2156	\$2242	\$2330	\$2756
LAMINATE			VENEER			ACRYLIC					
\$1477			\$2759			CALL					

OPTIONS

- CODE: FR - CAL 133 (TB 133) Fire Retardant
- CODE: MB - Moisture Barrier (up to 60" overall width)
- CODE: MB60 - Moisture Barrier (over 60" overall width)
- CODE: PC - Polished Chrome Legs
- CODE: WDL - Metal/Wood Legs. (Specify powder coat and wood color)
- CODE: WDL-C - Chrome/Wood Legs. (Specify wood color)
- CODE: 2FO - Two Fabric Option
- CODE: 3FO - Three Fabric Option
- CODE: GD - Ganging Device for metal/wood legs
(Necessary when ganging two or more modules together)
- CODE: TABF() - Fixed Laminate Tablet - outside of modular unit
(round post, specify tablet shape A, B or C)
- CODE: TABFB() - Fixed Laminate Tablet - between two modular units
(blade post, specify tablet shape A, B or C)

- CODE: TABR1() - Removable Tablet (shape A, B or C, left or right arm)
- CODE: TABR2() - Removable Tablet (shape A, B or C, hardware both arms)
- CODE: LAM5 - Non-standard laminate for 5 or less tablets
see options for upcharge
- CODE: SST - Solid Surface Tablet
- CODE: SS5 - Non-standard Solid Surface top for 5 or less tablets
- CODE: BWAC - Wood Arm Cap (Box Arm)
- CODE: WAC - Wood Arm Caps
- CODE: PAC - Poly Arm Caps
- CODE: ISB - Inset Back

Note: Factory installed power/data available, see accessories online under the 'Products' tab.



MODULAR - QUATTRO



CURVED PRIVACY PANEL



60° BACKLESS INSIDE CURVE



30° OUTSIDE CURVE



2 TONE FABRIC

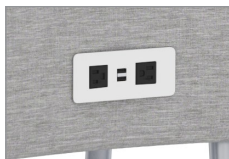

POWER/DATA

Laguna Leg Options

OPTIONAL METAL/WOOD LEG
CODE: WDL



OPTIONAL CHROME LEG
CODE: PC



OPTIONAL CHROME/WOOD LEG
CODE: WDL-C



WOOD ARM CAPS
(BOX ARMS)



WOOD ARM CAPS
(SLIM ARMS)



POLY ARM CAPS
(SLIM ARMS ONLY)

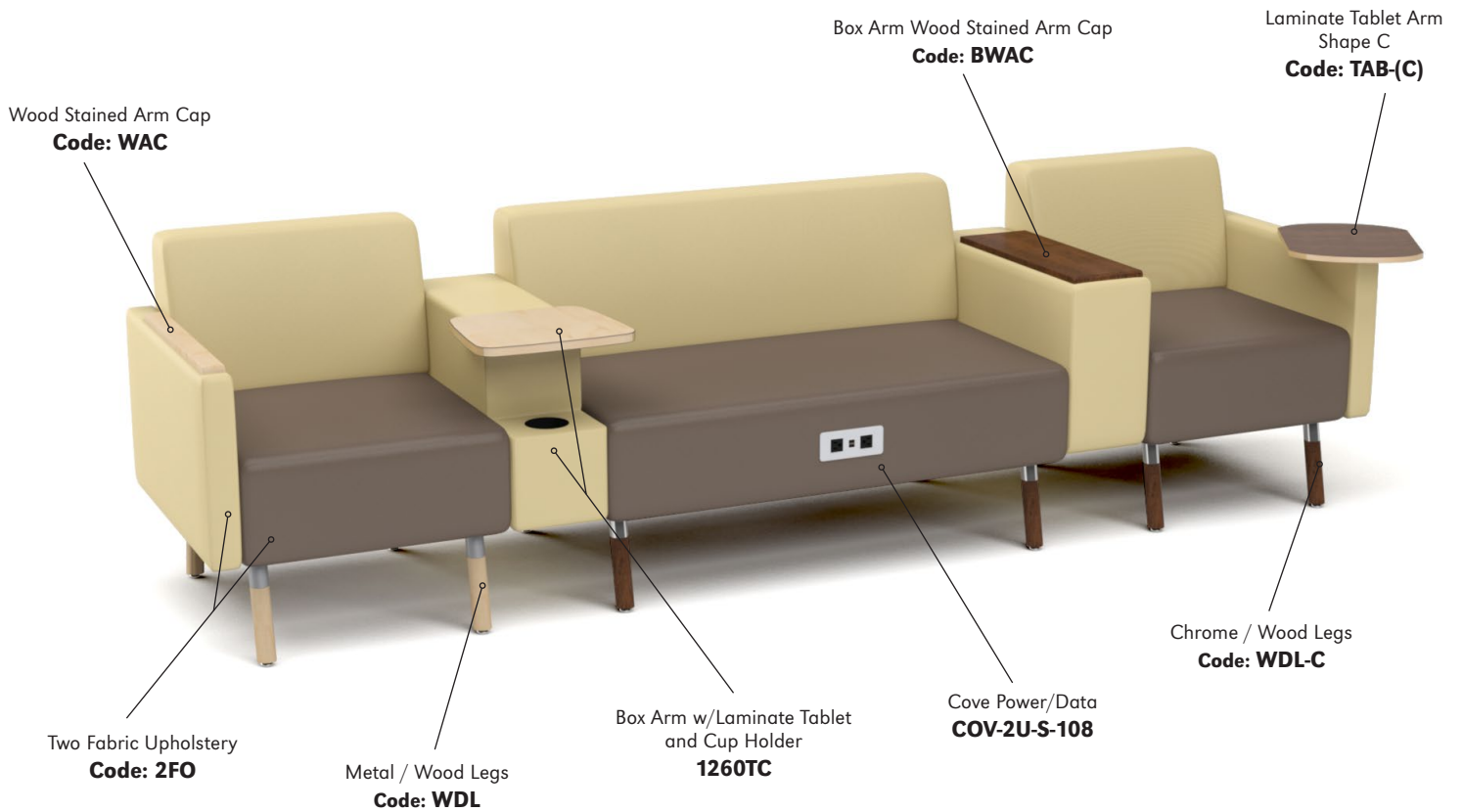
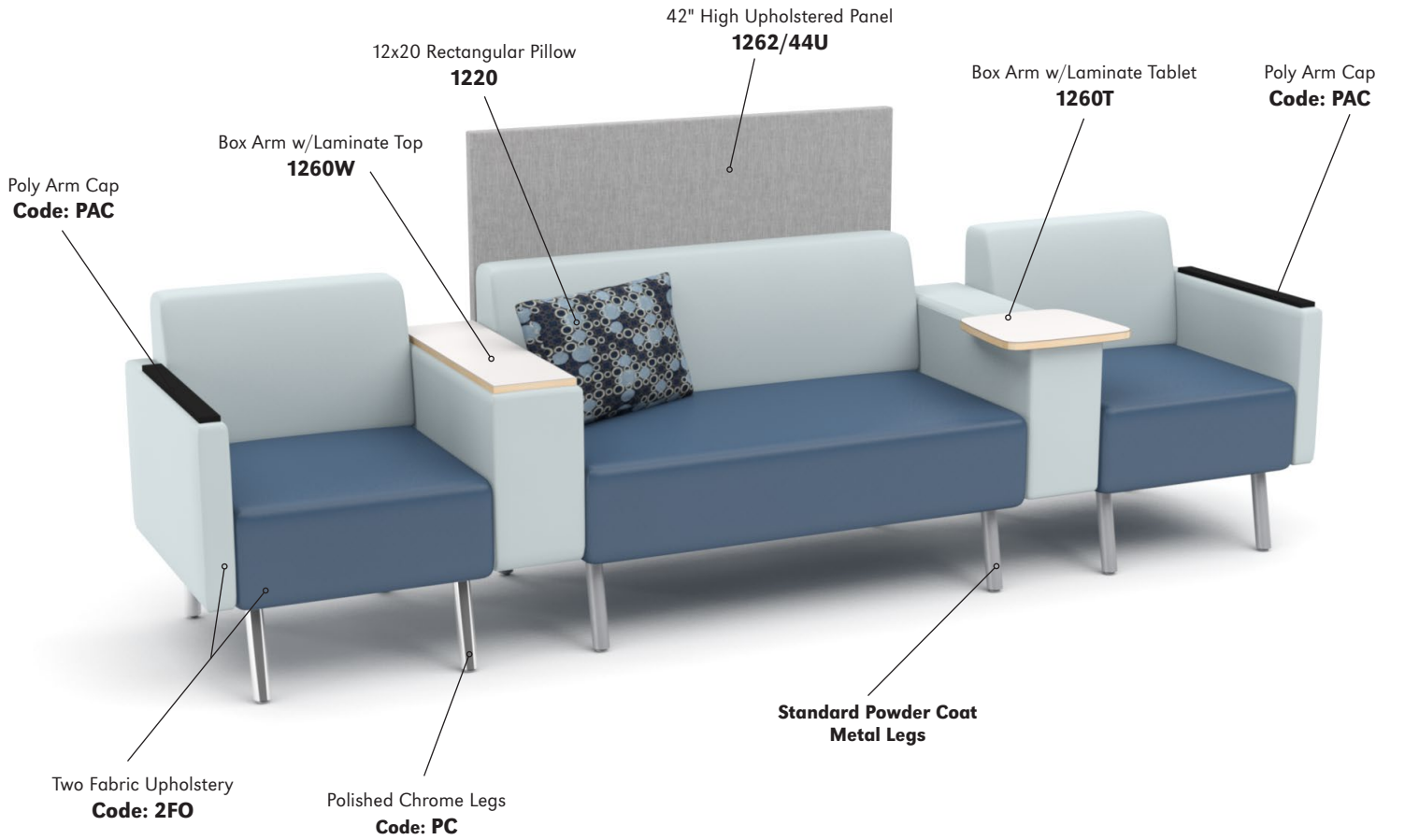

DIMENSIONS	22" Straight	30" Straight	44" Straight	Corner Unit
Seat Depth:	21"	21"	21"	21"
Seat Width:	22"	30"	44"	21"
Seat Height:	17"	17"	17"	17"
Overall Depth:	27"	27"	27"	27"
Overall Width:	22"	30"	44"	27"
Overall Height:	30"	30"	30"	30"
Qty./Wt.:	1 ea./58 lbs.	1 ea./68 lbs.	1 ea./85 lbs.	1 ea./58 lbs.



STRAIGHT UNIT WITH OPTIONAL METAL/WOOD LEGS



CORNER UNIT WITH OPTIONAL METAL/WOOD LEGS

MODEL / DESCRIPTION / LIST PRICING



1200 22" W Straight Units (4 Legs)

COM Yardage: Total: 3 Yds. / Back: 1.5 Yds. / Seat: 1.5 Yds.

COM	GR1	GR2	GR3	GR4	GR5	GR6	GR7	GR8	GR9	GR10	LEA
\$1334	\$1410	\$1487	\$1574	\$1650	\$1737	\$1825	\$1912	\$1999	\$2086	\$2173	\$2299



1202 30" W Straight Units (4 Legs)

COM Yardage: Total: 4 Yds. / Back: 1.75 Yds. / Seat: 2.25 Yds.

COM	GR1	GR2	GR3	GR4	GR5	GR6	GR7	GR8	GR9	GR10	LEA
\$1554	\$1647	\$1745	\$1854	\$1952	\$2061	\$2170	\$2279	\$2388	\$2497	\$2628	\$2753



1204 44" W Straight Units (4 Legs)

COM Yardage: Total: 4.5 Yds. / Back: 2 Yds. / Seat: 2.5 Yds.

COM	GR1	GR2	GR3	GR4	GR5	GR6	GR7	GR8	GR9	GR10	LEA
\$2178	\$2309	\$2439	\$2570	\$2701	\$2832	\$2963	\$3093	\$3224	\$3355	\$3486	\$3611



1218 Corner Unit (4 Legs)

COM Yardage: Total: 4.25 Yds. / Back: 2 Yds. / Seat: 2.25 Yds.

COM	GR1	GR2	GR3	GR4	GR5	GR6	GR7	GR8	GR9	GR10	LEA
\$2241	\$2361	\$2470	\$2590	\$2699	\$2819	\$2939	\$3059	\$3178	\$3298	\$3418	\$3544

OPTIONS

Add upcharge to list price and code to model number

FR	CAL 133 (TB 133) Fire Retardant per yard	\$90/yd.
MB	Moisture Barrier - up to 60" overall width	\$125
WDL	Metal/Wood Legs	\$35 each
WDL-C	Chrome/Wood Legs	\$60 each
PC	Polished Chrome Legs	\$35 each
2FO	Two Fabric Option	\$98
GD	Ganging Device	\$52

TABF(-)	Fixed Tablet (outside, specify (L/R), shape A, B or C)	\$370
TABFB(-)	Fixed Tablet (blade, specify (L/R), shape A, B or C)	\$370
LAM5	Non-standard laminate (5 tablets or less)	\$250 ea. tablet
SST	Solid Surface Tablet Arm - add to tablet option	\$125
SS5	Non-standard Solid Surface (5 tablets or less)	Call For Quote
ISB	Inset Back (Add to Standard Unit)	\$50

DIMENSIONS	30° Inside Curve	30° Outside Curve
Seat Depth:	21"	21"
Seat Width:	17"	31"
Seat Height:	17"	17"
Overall Depth:	27"/28"	27"/28"
Overall Width:	17"/31"	17"/31"
Overall Height:	30"	30"
Qty./Wt.:	1 ea./58 lbs.	1 ea./68 lbs.



INSIDE CURVE UNIT WITH
OPTIONAL METAL/WOOD LEGS

MODEL / DESCRIPTION / LIST PRICING



1212 Inside 30° Curve Unit (4 Legs)

COM Yardage: Total: 4 Yds. / Back: 2 Yds. / Seat: 2 Yds.

COM	GR1	GR2	GR3	GR4	GR5	GR6	GR7	GR8	GR9	GR10	LEA
\$1422	\$1499	\$1575	\$1662	\$1739	\$1826	\$1913	\$2000	\$2087	\$2175	\$2262	\$2387



1213 Outside 30° Curve Unit (4 Legs)

COM Yardage: Total: 3.5 Yds. / Back: 1.5 Yds. / Seat: 2 Yds.

COM	GR1	GR2	GR3	GR4	GR5	GR6	GR7	GR8	GR9	GR10	LEA
\$1504	\$1591	\$1668	\$1755	\$1831	\$1918	\$2006	\$2093	\$2180	\$2267	\$2354	\$2480

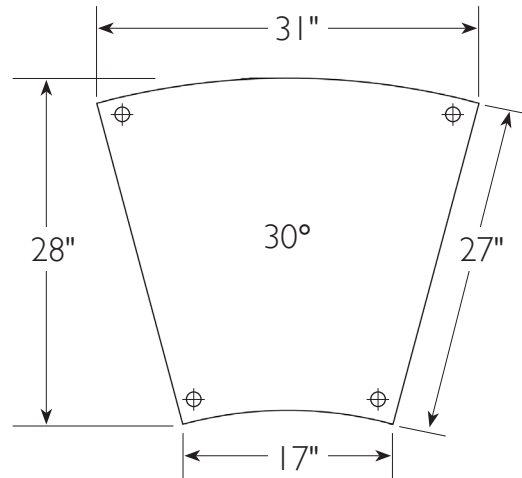

OPTIONS

Add upcharge to list price and code to model number

FR	CAL 133 (TB 133) Fire Retardant per yard	\$90/yd.
MB	Moisture Barrier - up to 60" overall width	\$125
WDL	Metal/Wood Legs	\$35 each
WDL-C	Chrome/Wood Legs	\$60 each
PC	Polished Chrome Legs	\$35 each
2FO	Two Fabric Option	\$98
GD	Ganging Device	\$52

TABF(-)	Fixed Tablet (outside, specify (L/R), shape A, B or C)	\$370
TABFB(-)	Fixed Tablet (blade, specify (L/R), shape A, B or C)	\$370
LAM5	Non-standard laminate (5 tablets or less)	\$250 ea. tablet
SST	Solid Surface Tablet Arm - add to tablet option	\$125
SS5	Non-standard Solid Surface (5 tablets or less)	Call For Quote
ISB	Inset Back (Add to Standard Unit)	\$50

DIMENSIONS	45° Inside Curve	45° Outside Curve
Seat Depth:	21"	21"
Seat Width:	25"	46"
Seat Height:	17"	17"
Overall Depth:	27"/29.5"	27"/29.5"
Overall Width:	25.25"/46"	25.25"/46"
Overall Height:	30"	30"
Qty./Wt.:	1 ea./58 lbs.	1 ea./68 lbs.



INSIDE CURVE UNIT WITH
OPTIONAL METAL/WOOD LEGS

MODEL / DESCRIPTION / LIST PRICING

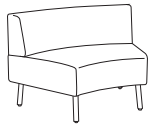

1214 Inside 45° Curve (4 Legs)

COM Yardage: Total: 5.5 Yds. / Back: 2.5 Yds. / Seat: 3 Yds.

COM	GR1	GR2	GR3	GR4	GR5	GR6	GR7	GR8	GR9	GR10	LEA
\$2106	\$2215	\$2324	\$2444	\$2553	\$2673	\$2793	\$2912	\$3032	\$3152	\$3272	\$3398



1215 Outside 45° Curve (4 Legs)

COM Yardage: Total: 5.25 Yds. / Back: 2.25 Yds. / Seat: 3 Yds.

COM	GR1	GR2	GR3	GR4	GR5	GR6	GR7	GR8	GR9	GR10	LEA
\$2349	\$2458	\$2567	\$2687	\$2796	\$2916	\$3036	\$3156	\$3275	\$3395	\$3515	\$3641

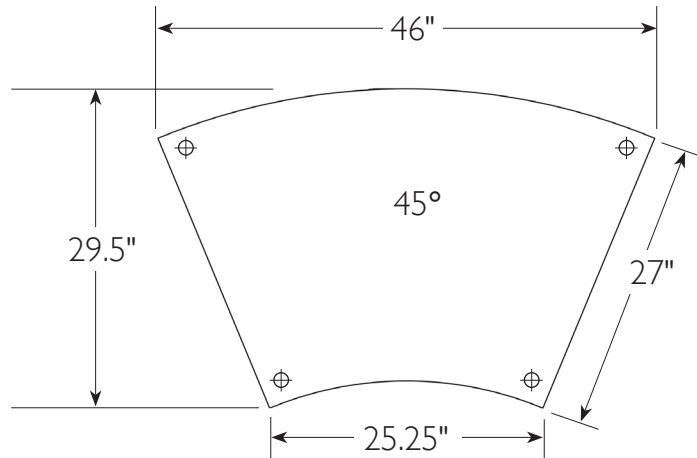

OPTIONS

Add upcharge to list price and code to model number

FR	CAL 133 (TB 133) Fire Retardant per yard	\$90/yd.
MB	Moisture Barrier - up to 60" overall width	\$125
WDL	Metal/Wood Legs	\$35 each
WDL-C	Chrome/Wood Legs	\$60 each
PC	Polished Chrome Legs	\$35 each
2FO	Two Fabric Option	\$98
GD	Ganging Device	\$52

TABF(-)	Fixed Tablet (outside, specify (L/R), shape A, B or C)	\$370
TABFB(-)	Fixed Tablet (blade, specify (L/R), shape A, B or C)	\$370
LAM5	Non-standard laminate (5 tablets or less)	\$250 ea. tablet
SST	Solid Surface Tablet Arm - add to tablet option	\$125
SS5	Non-standard Solid Surface (5 tablets or less)	Call For Quote
ISB	Inset Back (Add to Standard Unit)	\$50

DIMENSIONS	60° Inside Curve	60° Outside Curve
Seat Depth:	21"	21"
Seat Width:	33"	60"
Seat Height:	17"	17"
Overall Depth:	27"/31.5"	27"/31.5"
Overall Width:	33"/60"	33"/60"
Overall Height:	30"	30"
Qty./Wt.:	1 ea./58 lbs.	1 ea./68 lbs.



INSIDE CURVE UNIT WITH
OPTIONAL METAL/WOOD LEGS

MODEL / DESCRIPTION / LIST PRICING



1216 Inside 60° Curve (5 legs)

COM Yardage: Total: 7 Yds. / Back: 3 Yds. / Seat: 4 Yds.

COM	GR1	GR2	GR3	GR4	GR5	GR6	GR7	GR8	GR9	GR10	LEA
\$2245	\$2354	\$2463	\$2583	\$2692	\$2812	\$2932	\$3052	\$3172	\$3292	\$3412	\$3537

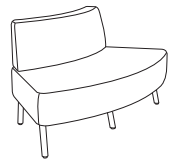

1217 Outside 60° Curve (5 legs)

COM Yardage: Total: 6.5 Yds. / Back: 2.5 Yds. / Seat: 4 Yds.

COM	GR1	GR2	GR3	GR4	GR5	GR6	GR7	GR8	GR9	GR10	LEA
\$2370	\$2490	\$2599	\$2718	\$2827	\$2947	\$3067	\$3187	\$3307	\$3427	\$3547	\$3672

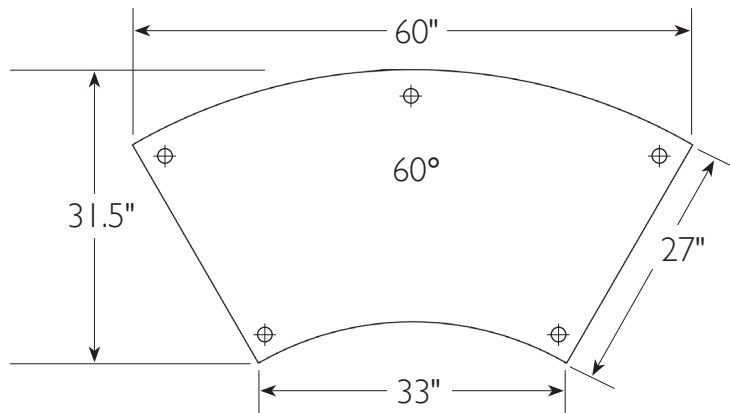

OPTIONS

Add upcharge to list price and code to model number

FR	CAL 133 (TB 133) Fire Retardant per yard	\$90/yd.
MB	Moisture Barrier - up to 60" overall width	\$125
WDL	Metal/Wood Legs	\$35 each
WDL-C	Chrome/Wood Legs	\$60 each
PC	Polished Chrome Legs	\$35 each
2FO	Two Fabric Option	\$98
GD	Ganging Device	\$52

TABF(-)	Fixed Tablet (outside, specify (L/R), shape A, B or C)	\$370
TABFB(-)	Fixed Tablet (blade, specify (L/R), shape A, B or C)	\$370
LAM5	Non-standard laminate (5 tablets or less)	\$250 ea. tablet
SST	Solid Surface Tablet Arm - add to tablet option	\$125
SS5	Non-standard Solid Surface (5 tablets or less)	Call For Quote
ISB	Inset Back (Add to Standard Unit)	\$50

DIMENSIONS	Straight Panel	Straight Panel	Straight Panel
Panel Depth:	1"	1"	1"
Overall Width:	22"	30"	44"
Overall Height:	48"	48"	48"
Qty./Approx Wt.:	1 ea./100 lbs.	1 ea./110 lbs.	1 ea./120 lbs.

Note: For Laminate or Acrylic, please call for quote.



STRAIGHT PRIVACY PANEL

MODEL / DESCRIPTION / LIST PRICING

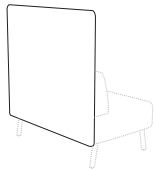

1262/22U	22" Straight Panel - Upholstered										COM Yardage - Panel: 1.5 Yds.	
COM	GR1	GR2	GR3	GR4	GR5	GR6	GR7	GR8	GR9	GR10	LEA	
\$623	\$667	\$694	\$722	\$751	\$780	\$812	\$844	\$877	\$912	\$949	\$1123	
1262/30U	30" Straight Panel - Upholstered										COM Yardage - Panel: 2 Yds.	
COM	GR1	GR2	GR3	GR4	GR5	GR6	GR7	GR8	GR9	GR10	LEA	
\$772	\$826	\$859	\$892	\$930	\$966	\$1005	\$1045	\$1087	\$1129	\$1175	\$1389	
1262/44U	44" Straight Panel - Upholstered										COM Yardage - Panel: 2.5 Yds.	
COM	GR1	GR2	GR3	GR4	GR5	GR6	GR7	GR8	GR9	GR10	LEA	
\$887	\$949	\$986	\$1027	\$1067	\$1111	\$1154	\$1201	\$1249	\$1299	\$1352	\$1596	

OPTIONS

Add upcharge to list price and code to model number

FR	CAL 133 (TB 133) Fire Retardant per yard	\$90/yd.	2FO	Two Fabric Option	\$98
----	--	----------	-----	-------------------	------

DIMENSIONS	Inset Straight Panel	Inset Straight Panel	Inset Straight Panel
Panel Depth:	1"	1"	1"
Overall Width:	18"	26"	40"
Overall Height:	48"	48"	48"
Qty./Approx Wt.:	1 ea./100 lbs.	1 ea./110 lbs.	1 ea./120 lbs.

Note: Upholstered panels are 1.0" thick.
For Laminate or Acrylic, please call for quote.



INSET STRAIGHT PRIVACY PANEL

MODEL / DESCRIPTION / LIST PRICING

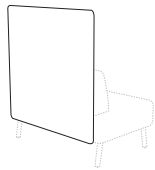

1263/18U		Inset 18" Inset Straight Panel - Upholstered										COM Yardage - Panel: 1.5 Yds.
COM	GR1	GR2	GR3	GR4	GR5	GR6	GR7	GR8	GR9	GR10	LEA	
\$678	\$722	\$749	\$776	\$806	\$835	\$867	\$898	\$932	\$967	\$1004	\$1177	
1263/26U		Inset 26" Inset Straight Panel - Upholstered										COM Yardage - Panel: 2 Yds.
COM	GR1	GR2	GR3	GR4	GR5	GR6	GR7	GR8	GR9	GR10	LEA	
\$826	\$881	\$913	\$946	\$984	\$1020	\$1059	\$1100	\$1141	\$1184	\$1230	\$1443	
1263/40U		Inset 40" Inset Straight Panel - Upholstered										COM Yardage - Panel: 2.5 Yds.
COM	GR1	GR2	GR3	GR4	GR5	GR6	GR7	GR8	GR9	GR10	LEA	
\$942	\$1004	\$1041	\$1081	\$1122	\$1165	\$1209	\$1256	\$1304	\$1354	\$1406	\$1650	

OPTIONS

Add upcharge to list price and code to model number

FR	CAL 133 (TB 133) Fire Retardant per yard	\$90/yd.	2FO	Two Fabric Option	\$98
----	--	----------	-----	-------------------	------

DIMENSIONS	Inside Curve Panel	Inside Curve Panel	Inside Curve Panel
Panel Depth:	1"	1"	1"
Overall Width:	31"	46"	60"
Overall Height:	48"	48"	48"
Qty./Approx Wt.:	1 ea./100 lbs.	1 ea./110 lbs.	1 ea./120 lbs.

DIMENSIONS	Outside Curve Panel	Outside Curve Panel	Outside Curve Panel
Panel Depth:	1"	1"	1"
Overall Width:	17"	25"	33"
Overall Height:	48"	48"	48"
Qty./Approx Wt.:	1 ea./100 lbs.	1 ea./110 lbs.	1 ea./120 lbs.

Note: Upholstered panels are 1.0" thick.
For Laminate or Acrylic, please call for quote.



45° INSIDE CURVE PRIVACY PANEL



45° OUTSIDE CURVE PANEL

MODEL / DESCRIPTION / LIST PRICING

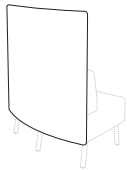

1270/30U 30° Inside Curve Panel - Upholstered COM Yardage - Panel: 2 Yds.

COM	GR1	GR2	GR3	GR4	GR5	GR6	GR7	GR8	GR9	GR10	LEA
\$1158	\$1237	\$1286	\$1339	\$1392	\$1449	\$1506	\$1566	\$1630	\$1693	\$1761	\$2083

1270/45U 45° Inside Curve Panel - Upholstered COM Yardage - Panel: 3 Yds.

COM	GR1	GR2	GR3	GR4	GR5	GR6	GR7	GR8	GR9	GR10	LEA
\$1331	\$1425	\$1481	\$1539	\$1602	\$1666	\$1733	\$1802	\$1873	\$1949	\$2025	\$2395

1270/60U 60° Inside Curve Panel - Upholstered COM Yardage - Panel: 4 Yds.

COM	GR1	GR2	GR3	GR4	GR5	GR6	GR7	GR8	GR9	GR10	LEA
\$2078	\$2223	\$2312	\$2406	\$2500	\$2600	\$2704	\$2813	\$2924	\$3042	\$3164	\$3740

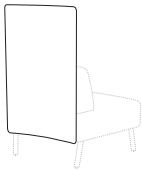

1272/30U 30° Outside Curve Panel - Upholstered COM Yardage - Panel: 2 Yds.

COM	GR1	GR2	GR3	GR4	GR5	GR6	GR7	GR8	GR9	GR10	LEA
\$984	\$1052	\$1093	\$1138	\$1183	\$1232	\$1281	\$1331	\$1385	\$1439	\$1498	\$1770

1272/45U 45° Outside Curve Panel - Upholstered COM Yardage - Panel: 3 Yds.

COM	GR1	GR2	GR3	GR4	GR5	GR6	GR7	GR8	GR9	GR10	LEA
\$1131	\$1211	\$1259	\$1308	\$1363	\$1416	\$1474	\$1531	\$1591	\$1657	\$1721	\$2035

1272/60U 60° Outside Curve Panel - Upholstered COM Yardage - Panel: 4 Yds.

COM	GR1	GR2	GR3	GR4	GR5	GR6	GR7	GR8	GR9	GR10	LEA
\$1766	\$1889	\$1965	\$2045	\$2126	\$2209	\$2299	\$2391	\$2486	\$2585	\$2690	\$3178

OPTIONS

Add upcharge to list price and code to model number

FR	CAL 133 (TB 133) Fire Retardant per yard	\$90/yd.	2FO	Two Fabric Option	\$98
----	--	----------	-----	-------------------	------

DIMENSIONS	Inset Inside Curve Panel	Inset Inside Curve Panel	Inset Inside Curve Panel
Panel Depth:	1"	1"	1"
Overall Width:	27"	42"	56"
Overall Height:	48"	48"	48"
Qty./Wt.:	1 ea./100 lbs.	1 ea./110 lbs.	1 ea./120 lbs.

DIMENSIONS	Inset Outside Curve Panel	Inset Outside Curve Panel	Inset Outside Curve Panel
Panel Depth:	1"	1"	1"
Overall Width:	13"	21"	29"
Overall Height:	48"	48"	48"
Qty./Wt.:	1 ea./100 lbs.	1 ea./110 lbs.	1 ea./120 lbs.



INSET INSIDE CURVE PRIVACY PANEL



INSET OUTSIDE CURVE PRIVACY PANEL

Note: Upholstered panels are 1.0" thick.
For Laminate or Acrylic, please call for quote.

MODEL / DESCRIPTION / LIST PRICING

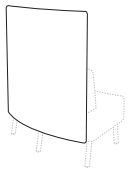

1271/30U Inset 30° Inside Curve Panel - Upholstered COM Yardage - Panel: 2 Yds.

COM	GR1	GR2	GR3	GR4	GR5	GR6	GR7	GR8	GR9	GR10	LEA
\$1212	\$1292	\$1341	\$1393	\$1446	\$1503	\$1561	\$1621	\$1684	\$1747	\$1816	\$2137

1271/45U Inset 45° Inside Curve Panel - Upholstered COM Yardage - Panel: 3 Yds.

COM	GR1	GR2	GR3	GR4	GR5	GR6	GR7	GR8	GR9	GR10	LEA
\$1385	\$1479	\$1536	\$1594	\$1657	\$1720	\$1788	\$1856	\$1927	\$2003	\$2080	\$2449

1271/60U Inset 60° Inside Curve Panel - Upholstered COM Yardage - Panel: 4 Yds.

COM	GR1	GR2	GR3	GR4	GR5	GR6	GR7	GR8	GR9	GR10	LEA
\$2132	\$2277	\$2366	\$2460	\$2555	\$2654	\$2759	\$2868	\$2979	\$3097	\$3219	\$3794

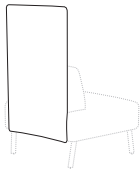

1273/30U Inset 30° Outside Curve Panel - Upholstered COM Yardage - Panel: 2 Yds.

COM	GR1	GR2	GR3	GR4	GR5	GR6	GR7	GR8	GR9	GR10	LEA
\$1039	\$1106	\$1148	\$1192	\$1237	\$1286	\$1335	\$1385	\$1440	\$1493	\$1552	\$1825

1273/45U Inset 45° Outside Curve Panel - Upholstered COM Yardage - Panel: 3 Yds.

COM	GR1	GR2	GR3	GR4	GR5	GR6	GR7	GR8	GR9	GR10	LEA
\$1186	\$1265	\$1313	\$1363	\$1417	\$1470	\$1528	\$1586	\$1646	\$1711	\$1776	\$2090

1273/60U Inset 60° Outside Curve Panel - Upholstered COM Yardage - Panel: 4 Yds.

COM	GR1	GR2	GR3	GR4	GR5	GR6	GR7	GR8	GR9	GR10	LEA
\$1820	\$1943	\$2020	\$2099	\$2180	\$2264	\$2353	\$2446	\$2541	\$2640	\$2745	\$3233

OPTIONS

Add upcharge to list price and code to model number

FR	CAL 133 (TB 133) Fire Retardant per yard	\$90/yd.	2FO	Two Fabric Option	\$98
----	--	----------	-----	-------------------	------

DIMENSIONS	Outside Slim Arm L/R	Center Slim Arm
Overall Depth:	27"	20"
Overall Width:	3"	3"
Arm Height:	24"	7"
Qty./Wt.:	1 ea./25 lbs.	1 ea./10 lbs.



MODEL / DESCRIPTION / LIST PRICING

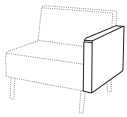

1259L Left Outside Slim Arm

COM Yardage: Total: 1.5 Yds.

COM	GR1	GR2	GR3	GR4	GR5	GR6	GR7	GR8	GR9	GR10	LEA
\$259	\$278	\$289	\$300	\$312	\$325	\$338	\$351	\$365	\$380	\$395	\$467

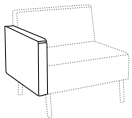

1259R Right Outside Slim Arm

COM Yardage: Total: 1.5 Yds.

COM	GR1	GR2	GR3	GR4	GR5	GR6	GR7	GR8	GR9	GR10	LEA
\$259	\$278	\$289	\$300	\$312	\$325	\$338	\$351	\$365	\$380	\$395	\$467

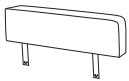

1259C Center Slim Arm

COM Yardage: Total: 1 Yds.

COM	GR1	GR2	GR3	GR4	GR5	GR6	GR7	GR8	GR9	GR10	LEA
\$238	\$281	\$314	\$358	\$390	\$423	\$456	\$488	\$532	\$576	\$619	\$717

TABLET SHAPES

Choose from 3 Tablet Shapes:

Tablets for all modular series are available in 3 shapes, choose from the three shapes shown and specify; A, B or C and left or right (outside tablet) when ordering. Example: TABF-(A) Left - this would be a fixed shape A tablet on the left side (when seated).

Optional Solid Surface available.

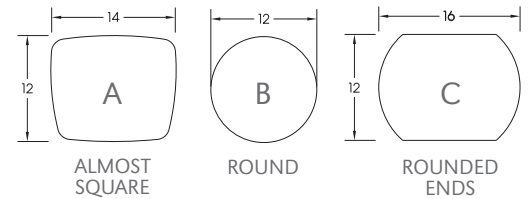

Tablet orders of 5 or less:

3 standard laminate colors:

Wilsonart Black 1595-60, Formica Brite White 459-58 or Nevamar Silver Alu Metalx MXT003.

4 standard Corian colors:

Bone, Bronzite, Glacier White, and Silver Grey.

OPTIONS

Add upcharge to list price and code to model number

FR	CAL 133 (TB 133) Fire Retardant per yard	\$90/yd.	TABR2-(L)	Removable Tablet (specify A, B or C both arm openings)	\$570
WAC	Wood Arm Cap (Slim Arm)	\$89 each	LAM5	Non-standard laminate (5 tablets or less)	\$250 ea. tablet
PAC	Poly Arm Cap - Standard Black/Charcoal (Slim Arm)	\$69 each	SST	Solid Surface Tablet Arm - add to tablet option	\$125
TAB-(L)	Swivel Tablet (specify A, B or C, left or right arm)	\$395	SS5	Non-standard Solid Surface (5 tablets or less)	Call For Quote
TABR1-(L)	Removable Tablet (specify A, B or C, left or right arm)	\$470			

DIMENSIONS	Center Box Arm
Overall Depth:	27"
Overall Width:	8"
Arm Height:	24"
Qty./Wt.:	1 ea./25 lbs.

Note: Box arms are only available as center arms



CENTER BOX ARMS

MODEL / DESCRIPTION / LIST PRICING

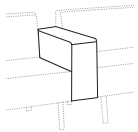

1260C Box Arm

COM Yardage: Total: 2 Yds

COM	GR1	GR2	GR3	GR4	GR5	GR6	GR7	GR8	GR9	GR10	LEA
\$316	\$360	\$392	\$436	\$469	\$501	\$534	\$567	\$610	\$654	\$698	\$796

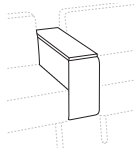

1260W Box Arm plus Table

COM Yardage: Total: 2 Yds

COM	GR1	GR2	GR3	GR4	GR5	GR6	GR7	GR8	GR9	GR10	LEA
\$659	\$703	\$736	\$779	\$812	\$845	\$877	\$910	\$954	\$997	\$1041	\$1139

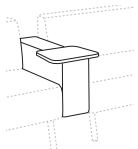

1260T Box Arm plus Fixed Tablet

COM Yardage: Total: 2 Yds

COM	GR1	GR2	GR3	GR4	GR5	GR6	GR7	GR8	GR9	GR10	LEA
\$621	\$665	\$698	\$741	\$774	\$807	\$839	\$872	\$916	\$959	\$1003	\$1101

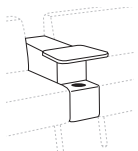

1260TC Box Arm plus Fixed Tablet plus Cup Holder

COM Yardage: Total: 2 Yds

COM	GR1	GR2	GR3	GR4	GR5	GR6	GR7	GR8	GR9	GR10	LEA
\$883	\$927	\$959	\$1003	\$1036	\$1068	\$1101	\$1134	\$1177	\$1221	\$1264	\$1363

Notes:

- **Box arm pricing includes ganging**
- Tablet orders of 5 or less - choice of 3 standard laminate colors: Wilsonart Black 1595-60, Formica Brite White 459-58 or Nevamar Silver Alu Metalx MXT003. Choice of 4 standard Corian colors: Bone, Bronzite, Glacier White, and Silver Grey.
- Solid surface tablet orders of 5 or less - choice of **Corian:** Bone, Bronzite, Glacier White, and Silver Grey.
- Tablet orders of 6 or more - any choice standard laminate colors.
- Optional Solid Surface available.

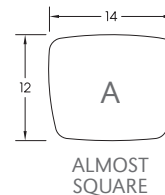

Box Arm Cap tablet available in Shape A only and is fixed

OPTIONS

Add upcharge to list price and code to model number

FR	CAL 133 (TB 133) Fire Retardant per yard	\$90/yd.	LAM5	Non-standard laminate (5 tablets or less)	\$250 ea. tablet
BWAC	Wood Arm Cap (Box Arm)	\$235 each	SST	Solid Surface Tablet Arm - add to tablet option	\$125
			SS5	Non-standard Solid Surface (5 tablets or less)	Call For Quote

DIMENSIONS	22" Straight	30" Straight	44" Straight
Seat Height:	17"	17"	17"
Overall Depth:	27"	27"	27"
Overall Width:	22"	30"	44"
Qty./Wt.:	1 ea./58 lbs.	1 ea./68 lbs.	1 ea./85 lbs.

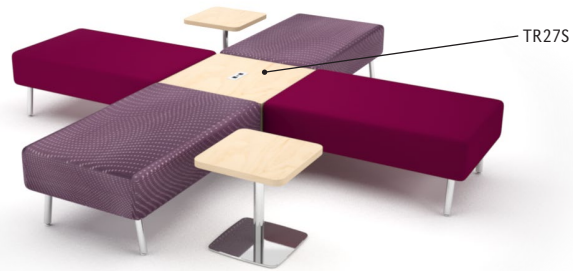

44" BACKLESS STRAIGHT UNIT COMPLEMENTED WITH TRENO AND DIXON OCCASIONAL TABLES

MODEL / DESCRIPTION / LIST PRICING

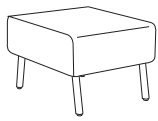

1226 22" W Backless Straight (4 Legs)

COM Yardage: Total: 2 Yds. / Sides: 1 Yds. / Top Front Rear 1 Yds.

COM	GR1	GR2	GR3	GR4	GR5	GR6	GR7	GR8	GR9	GR10	LEA
\$1168	\$1245	\$1321	\$1408	\$1485	\$1572	\$1659	\$1746	\$1833	\$1921	\$2008	\$2133



1228 30" W Backless Straight (4 Legs)

COM Yardage: Total: 2.75 Yds. / Sides: 1 Yds. / Top Front Rear 1.75 Yds.

COM	GR1	GR2	GR3	GR4	GR5	GR6	GR7	GR8	GR9	GR10	LEA
\$1384	\$1515	\$1646	\$1777	\$1908	\$2038	\$2169	\$2300	\$2431	\$2562	\$2692	\$2818



1230 44" W Backless Straight (4 Legs)

COM Yardage: Total: 3 Yds. / Sides: 1 Yds. / Top Front Rear 2 Yds.

COM	GR1	GR2	GR3	GR4	GR5	GR6	GR7	GR8	GR9	GR10	LEA
\$2024	\$2155	\$2286	\$2417	\$2547	\$2678	\$2809	\$2940	\$3071	\$3201	\$3332	\$3457

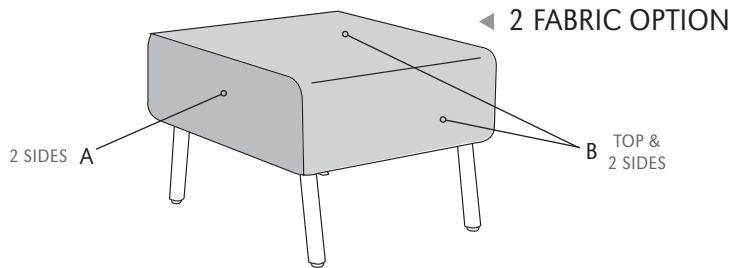

OPTIONS

Add upcharge to list price and code to model number

FR	CAL 133 (TB 133) Fire Retardant per yard	\$90/yd.
MB	Moisture Barrier - up to 60" overall width	\$125
WDL	Metal/Wood Legs	\$35 each
WDL-C	Chrome/Wood Legs	\$60 each
PC	Polished Chrome Legs	\$35 each
2FO	Two Fabric Option	\$98

GD	Ganging Device	\$52
TABF(-)	Fixed Tablet (outside, specify (L/R), shape A, B or C)	\$370
TABFB(-)	Fixed Tablet (blade, specify (L/R), shape A, B or C)	\$370
LAM5	Non-standard laminate (5 tablets or less)	\$250 ea. tablet
SST	Solid Surface Tablet Arm - add to tablet option	\$125
SS5	Non-standard Solid Surface (5 tablets or less)	Call For Quote

DIMENSIONS	30° Curve	45° Curve	60° Curve
Seat Height:	17"	17"	17"
Overall Depth:	27"/28"	27"/29.5"	27"/31.5"
Overall Width:	17"/31"	25.25"/46"	33"/60"
Qty./Wt.:	1 ea./58 lbs.	1 ea./68 lbs.	1 ea./85 lbs.



30° BACKLESS CURVE UNIT

MODEL / DESCRIPTION / LIST PRICING



1232 30° Backless Curve (4 Legs)

COM Yardage: Total: 2.25 Yds. / Sdies: 1 Yds. / Top-Front-Rear: 1.25 Yds

COM	GR1	GR2	GR3	GR4	GR5	GR6	GR7	GR8	GR9	GR10	LEA
\$1225	\$1301	\$1378	\$1465	\$1541	\$1628	\$1716	\$1803	\$1890	\$1977	\$2064	\$2190



1234 45° Backless Curve (4 Legs)

COM Yardage: Total: 3 Yds. / Sdies: 1 Yds. / Top-Front-Rear: 2 Yds

COM	GR1	GR2	GR3	GR4	GR5	GR6	GR7	GR8	GR9	GR10	LEA
\$1777	\$1853	\$1929	\$2017	\$2093	\$2180	\$2267	\$2354	\$2442	\$2529	\$2616	\$2741



1236 60° Backless Curve (5 Legs)

COM Yardage: Total: 4.5 Yds. / Sdies: 1 Yds. / Top-Front-Rear: 3.5 Yds

COM	GR1	GR2	GR3	GR4	GR5	GR6	GR7	GR8	GR9	GR10	LEA
\$1901	\$1977	\$2054	\$2141	\$2217	\$2304	\$2391	\$2479	\$2566	\$2653	\$2740	\$2866

OPTIONS

Add upcharge to list price and code to model number

FR	CAL 133 (TB 133) Fire Retardant per yard	\$90/yd.
MB	Moisture Barrier - up to 60" overall width	\$125
WDL	Metal/Wood Legs	\$35 each
WDL-C	Chrome/Wood Legs	\$60 each
PC	Polished Chrome Legs	\$35 each
2FO	Two Fabric Option	\$98

GD	Ganging Device	\$52
TABF-(L)	Fixed Tablet (outside, specify (L/R), shape A, B or C)	\$370
TABFB-(L)	Fixed Tablet (blade, specify (L/R), shape A, B or C)	\$370
LAM5	Non-standard laminate (5 tablets or less)	\$250 ea. tablet
SST	Solid Surface Tablet Arm - add to tablet option	\$125
SS5	Non-standard Solid Surface (5 tablets or less)	Call For Quote

DIMENSIONS	Quattro
Seat Height:	17"
Overall Depth:	54"
Overall Width:	54"
Overall Height:	17"
Seat Depth:	27"
Qty./Wt.:	1 ea./90 lbs.



QUATTRO

MODEL / DESCRIPTION / LIST PRICING

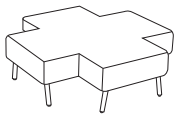

1225 Quattro (8 Legs)

COM Yardage: Total: 6 Yds. / Top: 3 Yds. / Sides: 3 Yds.

COM	GR1	GR2	GR3	GR4	GR5	GR6	GR7	GR8	GR9	GR10	LEA
\$3997	\$4128	\$4259	\$4389	\$4520	\$4651	\$4782	\$4913	\$5043	\$5174	\$5305	\$5430

INCLUDES CENTER SUPPORT COLUMN

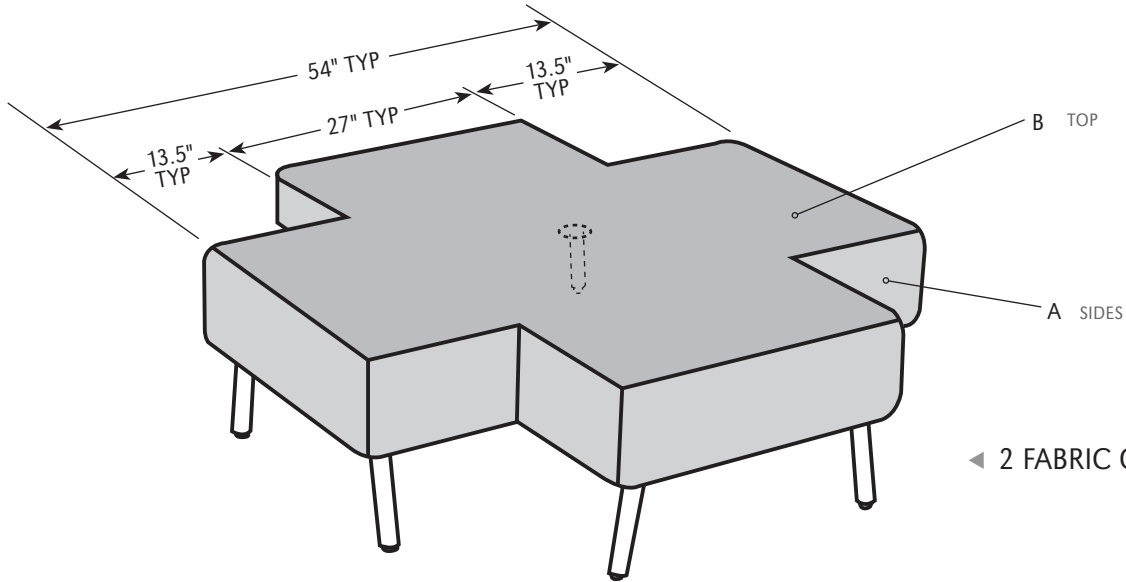

◀ 2 FABRIC OPTION

OPTIONS

Add upcharge to list price and code to model number

FR	CAL 133 (TB 133) Fire Retardant per yard	\$90/yd.
MB60	Moisture Barrier - over 60" overall width	\$200
WDL	Metal/Wood Legs	\$35 each
WDL-C	Chrome/Wood Legs	\$60 each
PC	Polished Chrome Legs	\$35 each
2FO	Two Fabric Option	\$98

GD	Ganging Device	\$52
TABF(-)	Fixed Tablet (outside, specify (L/R), shape A, B or C)	\$370
TABFB(-)	Fixed Tablet (blade, specify (L/R), shape A, B or C)	\$370
LAM5	Non-standard laminate (5 tablets or less)	\$250 ea. tablet
SST	Solid Surface Tablet Arm - add to tablet option	\$125
SS5	Non-standard Solid Surface (5 tablets or less)	Call For Quote

Note: Due to it's size, Moisture Barrier is priced at MB60 pricing.

OPTIONS

- CODE: FR - CAL 133 (TB 133) Fire Retardant
- CODE: MB - Moisture Barrier (up to 60" overall width)
- CODE: MB60 - Moisture Barrier (over 60" overall width)
- CODE: PC - Polished Chrome Legs
- CODE: WDL - Metal/Wood Legs. (Specify powder coat and wood color)
- CODE: WDL-C - Chrome/Wood Legs. (Specify wood color)
- CODE: 2FO - Two Fabric Option
- CODE: 3FO - Three Fabric Option
- CODE: PAC-L - Poly Arm Caps
- CODE: WAC-L - Wood Arm Caps
- CODE: BWAC - Wood Arm Caps for Box Arm
- CODE: TAB-(_) - Swivel Tablet (shape A, B or C, left or right arm)
- CODE: TABR1-(_) - Removable Tablet (shape A, B or C, left or right arm)
- CODE: TABR2-(_) - Removable Tablet (shape A, B or C, hardware both arms)
- CODE: LAM5 - Non-standard laminate for 5 or less tablets see options for upcharge
- CODE: SST - Solid Surface Tablet Arm
- CODE: SS5 - Non-standard Solid Surface top for 5 or less tablets

TABLET SHAPES

Choose from 3 Tablet Shapes:

Tablets for all modular series are available in 3 shapes, choose from the three shapes shown and specify; A, B or C and left or right (outside tablet) when ordering. Example: TABF-(A) Left - this would be a fixed shape A tablet on the left side (when seated).

Optional Solid Surface available.

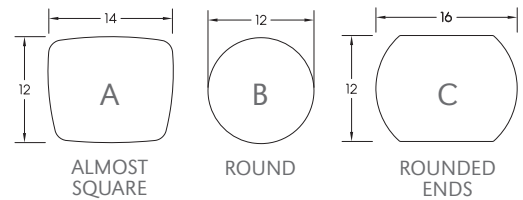

Tablet orders of 5 or less:

3 standard laminate colors:

Wilsonart Black 1595-60, Formica Brite White 459-58 or Nevamar Silver Alu Metalx MXT003.

4 standard Corian colors:

Bone, Bronzite, Glacier White, and Silver Grey.

Note:

- Tablet orders of 5 or less - choice of 3 standard laminate colors: Wilsonart Black 1595-60, Formica Brite White 459-58 or Nevamar Silver Alu Metalx MXT003.
- Tablet orders of 6 or more - any choice standard laminate colors.

Note: Factory installed power/data available, see accessories online under the 'Products' tab.



SINGLE SEAT LOUNGE WITH OPTIONAL TABLET ARM AND METAL/WOOD LEGS



BARIATRIC LOUNGE

DIMENSIONS	22" Straight	30" Straight	44" Straight
Seat Depth:	21"	21"	21"
Seat Width:	22"	30"	44"
Seat Height:	17"	17"	17"
Overall Depth:	27"	27"	27"
Overall Width:	27"	35"	49"
Overall Height:	30"	30"	30"
Qty./Wt.:	1 ea./75 lbs.	1 ea./90 lbs.	1 ea./110 lbs.



TWO SEAT LOUNGE

MODEL / DESCRIPTION / LIST PRICING



1200L Single Seat Lounge

COM Yardage: Total: 5.5 Yds. / Back: 1.5 Yds. / Seat: 1.5 Yds. / Arms 2.5 Yds.

COM	GR1	GR2	GR3	GR4	GR5	GR6	GR7	GR8	GR9	GR10	LEA
\$2243	\$2374	\$2505	\$2636	\$2766	\$2897	\$3028	\$3159	\$3290	\$3420	\$3551	\$3677



1202L Bariatric Lounge

COM Yardage: Total: 6.5 Yds. / Back: 1.75 Yds. / Seat: 2.25 Yds. / Arms 2.5 Yds.

COM	GR1	GR2	GR3	GR4	GR5	GR6	GR7	GR8	GR9	GR10	LEA
\$2910	\$3074	\$3205	\$3335	\$3466	\$3597	\$3728	\$3859	\$3989	\$4120	\$4251	\$4376

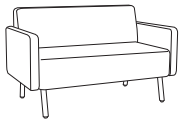

1204L Two Seat Lounge

COM Yardage: Total: 7.5 Yds. / Back: 2.5 Yds. / Seat: 2.5 Yds. / Arms 2.5 Yds.

COM	GR1	GR2	GR3	GR4	GR5	GR6	GR7	GR8	GR9	GR10	LEA
\$3257	\$3420	\$3551	\$3682	\$3813	\$3944	\$4074	\$4205	\$4336	\$4467	\$4598	\$4723

OPTIONS

Add upcharge to list price and code to model number

FR	CA133 Fire Retardant per yard	\$90/yd.	3FO	Three Fabric Option	\$148
MB	Moisture Barrier - per seat	\$125	TAB(-)	Swivel Tablet (specify A, B or C, left or right arm)	\$395
PAC	Poly Arm Cap - Standard Black/Charcoal (Slim Arm)	\$69 each	TABR1(-)	Removable Tablet (specify A, B or C, left or right arm)	\$470
WAC	Wood Arm Cap (Slim Arm)	\$89 each	TABR2(-)	Removable Tablet (specify A, B or C both arm openings)	\$570
WDL	Metal/Wood Legs	\$35 each	LAM5	Non-standard laminate (5 tablets or less)	\$250 ea. tablet
WDL-C	Chrome/Wood Legs	\$60 each	SST	Solid Surface Tablet Arm - add to tablet option	\$125
PC	Polished Chrome Legs	\$35 each	SS5	Non-standard Solid Surface (5 tablets or less)	Call For Quote
2FO	Two Fabric Option	\$98			

DIMENSIONS	Single Hideout	Two Seat Hideout
Seat Depth:	21"	21"
Seat Width:	30"	44"
Seat Height:	17"	17"
Overall Depth:	29"	29"
Overall Width:	33"	47"
Overall Height:	48"	48"
Qty./Wt.:	1 ea./150 lbs.	1 ea./175 lbs.



TWO SEAT HIDEOUT WITH 22" BOLSTERS
WOOD LEGS AND DIXON LAPTOP TABLE



HIDEOUT PROFILE VIEW

MODEL / DESCRIPTION / LIST PRICING



1222 Single Hideout (4 Legs)

COM Yardage: Total: 12.75 Yds. / Seat: 2.25 Yds. / Back: 1.5 Yds. / Panels 9 Yds.

COM	GR1	GR2	GR3	GR4	GR5	GR6	GR7	GR8	GR9	GR10	LEA
\$3543	\$3635	\$3733	\$3842	\$3940	\$4049	\$4158	\$4267	\$4376	\$4485	\$4616	\$4742



1224 Two Seat Hideout (4 Legs)

COM Yardage: Total: 13.75 Yds. / Seat: 2.75 Yds. / Back: 2 Yds. / Panels 9 Yds.

COM	GR1	GR2	GR3	GR4	GR5	GR6	GR7	GR8	GR9	GR10	LEA
\$4385	\$4516	\$4647	\$4777	\$4908	\$5039	\$5170	\$5301	\$5431	\$5562	\$5693	\$5818

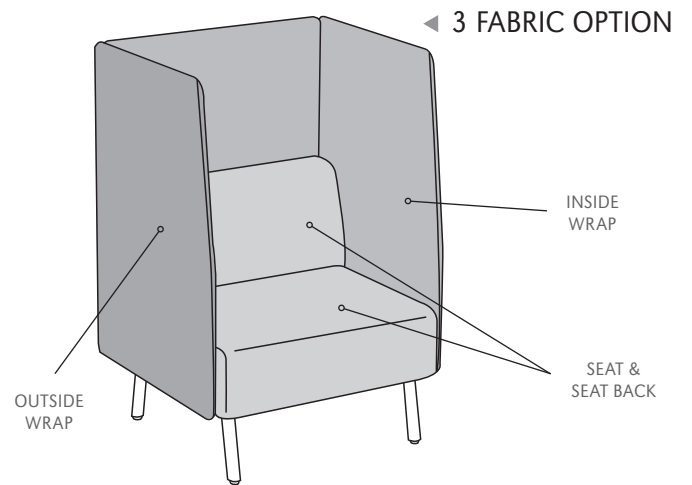
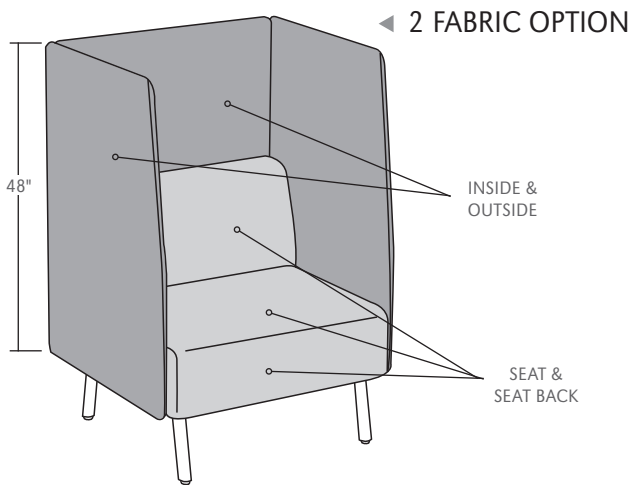

NOTE: 1.5" THICK FINISHED PANEL
SHIPPED COMPLETELY ASSEMBLED

OPTIONS

Add upcharge to list price and code to model number

FR	CAL 133 (TB 133) Fire Retardant per yard	\$90/yd.
MB	Moisture Barrier - up to 60" overall width	\$125
WDL	Metal/Wood Legs	\$35 each
WDL-C	Chrome/Wood Legs	\$60 each

PC	Polished Chrome Legs	\$35 each
2FO	Two Fabric Option	\$98
3FO	Three Fabric Option	\$148
GD	Ganging Device	\$52

DIMENSIONS	22" Bolster	30" Bolster	44" Bolster	12"x20" Pillow	16"x16" Pillow
Overall Depth:	6"	6"	6"	4"	4"
Overall Width:	22"	30"	44"	20"	16"
Overall Height:	6"	6"	6"	12"	16"
Qty./Wt.:	1 ea./25 lbs.	1 ea./25 lbs.	1 ea./25 lbs.	1 ea./25 lbs.	1 ea./25 lbs.



LAGUNA TWO SEAT HIDEOUT WITH 44" BOLSTER

MODEL / DESCRIPTION / LIST PRICING



1219-22 22" Round Bolster

COM Yardage: Total: .75 Yds.

COM	GR1	GR2	GR3	GR4	GR5	GR6	GR7	GR8	GR9	GR10	LEA
\$276	\$295	\$307	\$319	\$332	\$346	\$360	\$374	\$389	\$404	\$421	\$497



1219-30 30" Round Bolster

COM Yardage: Total: 1 Yds.

COM	GR1	GR2	GR3	GR4	GR5	GR6	GR7	GR8	GR9	GR10	LEA
\$344	\$368	\$384	\$399	\$415	\$432	\$449	\$467	\$485	\$505	\$525	\$620



1219-44 44" Round Bolster

COM Yardage: Total: 1.5 Yds.

COM	GR1	GR2	GR3	GR4	GR5	GR6	GR7	GR8	GR9	GR10	LEA
\$439	\$470	\$488	\$508	\$529	\$549	\$572	\$594	\$618	\$643	\$669	\$790



1220 12" x 20" Rectangle Pillow

COM Yardage: Total: .75 Yds.

COM	GR1	GR2	GR3	GR4	GR5	GR6	GR7	GR8	GR9	GR10	LEA
\$341	\$365	\$379	\$395	\$410	\$427	\$444	\$461	\$480	\$499	\$519	\$614



1221 16" x 16" Square Pillow

COM Yardage: Total: .75 Yds.

COM	GR1	GR2	GR3	GR4	GR5	GR6	GR7	GR8	GR9	GR10	LEA
\$362	\$387	\$402	\$419	\$435	\$452	\$471	\$489	\$509	\$529	\$550	\$651

OPTIONS

Add upcharge to list price and code to model number

FR	CAL 133 (TB 133) Fire Retardant per yard	\$90/yd.	MB	Moisture Barrier - per pillow/bolster	\$125
----	--	----------	----	---------------------------------------	-------

DIMENSIONS	22" Straight	44" Straight	66" Straight
Overall Depth:	20"	20"	20"
Overall Width:	22"	44"	66"
Overall Height:	17"	17"	17"
Table Height	16"	16"	16"
Qty./Wt.:	1 ea./58 lbs.	1 ea./68 lbs.	1 ea./85 lbs.

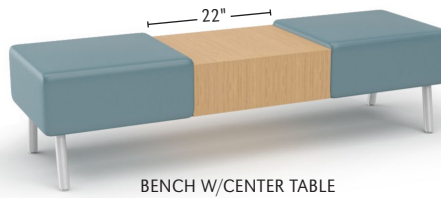

44" BENCH

MODEL / DESCRIPTION / LIST PRICING



1254 22" W Straight Bench (4 Legs)

COM Yardage: Total: 2 Yds. / Sides: 1 Yds. / Top: 1 Yds.

COM	GR1	GR2	GR3	GR4	GR5	GR6	GR7	GR8	GR9	GR10	LEA
\$1025	\$1101	\$1177	\$1264	\$1341	\$1428	\$1515	\$1602	\$1690	\$1777	\$1864	\$1989



1256 44" W Straight Bench (4 Legs)

COM Yardage: Total: 3 Yds. / Sides: 1.5 Yds. / Top: 1.5 Yds.

COM	GR1	GR2	GR3	GR4	GR5	GR6	GR7	GR8	GR9	GR10	LEA
\$1764	\$1894	\$2025	\$2156	\$2287	\$2418	\$2548	\$2679	\$2810	\$2941	\$3072	\$3197

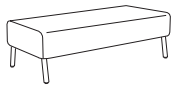

1258 66" W Straight Bench (4 Legs)

COM Yardage: Total: 4 Yds. / Sides: 2 Yds. / Top: 2 Yds.

COM	GR1	GR2	GR3	GR4	GR5	GR6	GR7	GR8	GR9	GR10	LEA
\$2058	\$2189	\$2320	\$2450	\$2581	\$2712	\$2843	\$2974	\$3104	\$3235	\$3366	\$3491

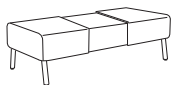

1258T 66" W Straight Bench with Center **LAMINATE** Table (4 Legs)

COM Yardage: Total: 4 Yds. / Sides: 2 Yds. / Top: 2 Yds.

COM	GR1	GR2	GR3	GR4	GR5	GR6	GR7	GR8	GR9	GR10	LEA
\$2200	\$2330	\$2461	\$2592	\$2723	\$2854	\$2984	\$3115	\$3246	\$3377	\$3508	\$3633

1258V 66" W Straight Bench with Center **VENEER** Table (4 Legs)

COM	GR1	GR2	GR3	GR4	GR5	GR6	GR7	GR8	GR9	GR10	LEA
\$2311	\$2442	\$2572	\$2703	\$2834	\$2965	\$3096	\$3226	\$3357	\$3488	\$3619	\$3744

OPTIONS

Add upcharge to list price and code to model number

FR	CAL 133 (TB 133) Fire Retardant per yard	\$90/yd.
MB	Moisture Barrier - up to 60" overall width	\$125
MB60	Moisture Barrier - over 60" overall width	\$200
PC	Polished Chrome Legs	\$35 each

WDL	Metal/Wood Legs	\$35 each
WDLC	Chrome/Wood Legs	\$60 each
2FO	Two Fabric Option	\$98

DIMENSIONS	24" Dia Ottoman	30" Dia Ottoman	36" Dia Ottoman	42" Dia Ottoman
Overall Depth:	24"	30"	36"	42"
Overall Width:	24"	30"	36"	42"
Overall Height:	16"	16"	16"	16"
Qty./Wt.:	1 ea./20 lbs.	1 ea./29 lbs.	1 ea./42 lbs.	1 ea./59 lbs.



ROUND OTTOMAN 24" DIAMETER

MODEL / DESCRIPTION / LIST PRICING



1238 24" Diameter Ottoman (4 Legs)

COM Yardage: Total: 2.25 Yds. / Sides: 1.5 Yds. / Top: .75 Yds.

COM	GR1	GR2	GR3	GR4	GR5	GR6	GR7	GR8	GR9	GR10	LEA
\$1079	\$1210	\$1341	\$1472	\$1602	\$1733	\$1864	\$1995	\$2126	\$2256	\$2387	\$2512



1240 30" Diameter Ottoman (4 Legs)

COM Yardage: Total: 2.75 Yds. / Sides: 1.75 Yds. / Top: 1 Yds.

COM	GR1	GR2	GR3	GR4	GR5	GR6	GR7	GR8	GR9	GR10	LEA
\$1280	\$1410	\$1541	\$1672	\$1803	\$1934	\$2064	\$2195	\$2326	\$2457	\$2588	\$2713

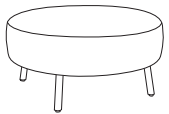

1242 36" Diameter Ottoman (4 Legs)

COM Yardage: Total: 3.25 Yds. / Sides: 2 Yds. / Top: 1.25 Yds.

COM	GR1	GR2	GR3	GR4	GR5	GR6	GR7	GR8	GR9	GR10	LEA
\$1400	\$1530	\$1661	\$1792	\$1923	\$2054	\$2184	\$2315	\$2446	\$2577	\$2708	\$2833



1244 42" Diameter Ottoman (5 Legs)

COM Yardage: Total: 3.75 Yds. / Sides: 2.25 Yds. / Top: 1.5 Yds.

COM	GR1	GR2	GR3	GR4	GR5	GR6	GR7	GR8	GR9	GR10	LEA
\$1705	\$1836	\$1966	\$2097	\$2228	\$2359	\$2490	\$2620	\$2751	\$2882	\$3013	\$3138

OPTIONS

Add upcharge to list price and code to model number

FR	CAL 133 (TB 133) Fire Retardant per yard	\$90/yd.
MB	Moisture Barrier - per ottoman	\$125
PC	Polished Chrome Legs	\$35 each

WDL	Metal/Wood Legs	\$35 each
WDL-C	Chrome/Wood Legs	\$60 each
2FO	Two Fabric Option	\$98

DIMENSIONS	18" Dia Ottoman	24" Dia Ottoman	30" Dia Ottoman	36" Dia Ottoman	42" Dia Ottoman
Overall Depth:	18"	24"	30"	36"	42"
Overall Width:	18"	24"	30"	36"	42"
Overall Height:	16"	16"	16"	16"	16"
Qty./Wt.:	1 ea./14 lbs.	1 ea./22 lbs.	1 ea./35 lbs.	1 ea./51 lbs.	1 ea./69 lbs.



ROUND OTTOMAN WITH
OPTIONAL CASTERS

Note: glides are installed

MODEL / DESCRIPTION / LIST PRICING



1237NL 18" Diameter Ottoman No Legs (casters not available)

COM Yardage: Total: 2.25 Yds. / Top: .75 Yds. / Sides: 1.5 Yds.

COM	GR1	GR2	GR3	GR4	GR5	GR6	GR7	GR8	GR9	GR10	LEA
\$876	\$1007	\$1138	\$1269	\$1400	\$1530	\$1661	\$1792	\$1923	\$2054	\$2184	\$2310

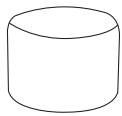

1238NL 24" Diameter Ottoman No Legs (4 casters needed)

COM Yardage: Total: 2.25 Yds. / Top: .75 Yds. / Sides: 1.5 Yds.

COM	GR1	GR2	GR3	GR4	GR5	GR6	GR7	GR8	GR9	GR10	LEA
\$996	\$1127	\$1258	\$1389	\$1519	\$1650	\$1781	\$1912	\$2043	\$2173	\$2304	\$2430

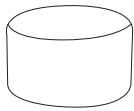

1240NL 30" Diameter Ottoman No Legs (4 casters needed)

COM Yardage: Total: 2.75 Yds. / Top: 1 Yds. / Sides: 1.75 Yds.

COM	GR1	GR2	GR3	GR4	GR5	GR6	GR7	GR8	GR9	GR10	LEA
\$1182	\$1312	\$1443	\$1574	\$1705	\$1836	\$1966	\$2097	\$2228	\$2359	\$2490	\$2615

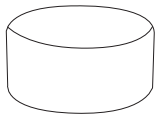

1242NL 36" Diameter Ottoman No Legs (4 casters needed)

COM Yardage: Total: 4.25 Yds. / Top: 1.25 Yds. / Sides: 3 Yds.

COM	GR1	GR2	GR3	GR4	GR5	GR6	GR7	GR8	GR9	GR10	LEA
\$1292	\$1422	\$1553	\$1684	\$1815	\$1946	\$2076	\$2207	\$2338	\$2469	\$2600	\$2725

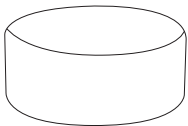

1244NL 42" Diameter Ottoman No Legs (5 casters needed)

COM Yardage: Total: 4.5 Yds. / Top: 1.5 Yds. / Sides: 3 Yds.

COM	GR1	GR2	GR3	GR4	GR5	GR6	GR7	GR8	GR9	GR10	LEA
\$1574	\$1705	\$1836	\$1966	\$2097	\$2228	\$2359	\$2490	\$2620	\$2751	\$2882	\$3007

OPTIONS

Add upcharge to list price and code to model number

FR	CAL 133 (TB 133) Fire Retardant per yard	\$90/yd.
MB	Moisture Barrier - per ottoman	\$125

2FO	Two Fabric Option	\$98
CAS3	Black 3" Casters (not available on 18" size)	\$25 each

DIMENSIONS	24" Square Ottoman	30" Square Ottoman	36" Square Ottoman	42" Square Ottoman
Overall Depth:	24"	30"	36"	42"
Overall Width:	24"	30"	36"	42"
Overall Height:	16"	16"	16"	16"
Qty./Wt.:	1 ea./24 lbs.	1 ea./37 lbs.	1 ea./54 lbs.	1 ea./75 lbs.



30" ALMOST SQUARE OTTOMAN

MODEL / DESCRIPTION / LIST PRICING



1246 24" Almost Square Ottoman (4 Legs)

COM Yardage: Total: 2 Yds. / Sides: 1 Yds. / Top: 1 Yds.

COM	GR1	GR2	GR3	GR4	GR5	GR6	GR7	GR8	GR9	GR10	LEA
\$1112	\$1243	\$1373	\$1504	\$1635	\$1766	\$1897	\$2027	\$2158	\$2289	\$2420	\$2545



1248 30" Almost Square Ottoman (4 Legs)

COM Yardage: Total: 2.5 Yds. / Sides: 1.5 Yds. / Top: 1 Yds.

COM	GR1	GR2	GR3	GR4	GR5	GR6	GR7	GR8	GR9	GR10	LEA
\$1293	\$1424	\$1554	\$1685	\$1816	\$1947	\$2078	\$2208	\$2339	\$2470	\$2601	\$2726



1250 36" Almost Square Ottoman (4 Legs)

COM Yardage: Total: 3 Yds. / Sides: 1.75 Yds. / Top: 1.25 Yds.

COM	GR1	GR2	GR3	GR4	GR5	GR6	GR7	GR8	GR9	GR10	LEA
\$1415	\$1546	\$1676	\$1807	\$1938	\$2069	\$2200	\$2330	\$2461	\$2592	\$2723	\$2848

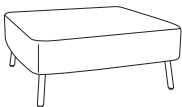

1252 42" Almost Square Ottoman (4 Legs)

COM Yardage: Total: 3.25 Yds. / Sides: 1.75 Yds. / Top: 1.5 Yds.

COM	GR1	GR2	GR3	GR4	GR5	GR6	GR7	GR8	GR9	GR10	LEA
\$1735	\$1866	\$1997	\$2128	\$2258	\$2389	\$2520	\$2651	\$2782	\$2912	\$3043	\$3169

OPTIONS

Add upcharge to list price and code to model number

FR	CAL 133 (TB 133) Fire Retardant per yard	\$90/yd.	WDL	Metal/Wood Legs	\$35 each
MB	Moisture Barrier - per ottoman	\$125	WDLC	Chrome/Wood Legs	\$60 each
PC	Polished Chrome Legs	\$35 each	2FO	Two Fabric Option	\$98

DIMENSIONS	18" Square Ottoman	24" Square Ottoman	30" Square Ottoman	36" Square Ottoman	42" Square Ottoman
Overall Depth:	18"	24"	30"	36"	42"
Overall Width:	18"	24"	30"	36"	42"
Overall Height:	16"	16"	16"	16"	16"
Qty./Wt.:	1 ea./17 lbs.	1 ea./29 lbs.	1 ea./45 lbs.	1 ea./65 lbs.	1 ea./88 lbs.

Note: glides are installed



24" OTTOMAN WITH OPTIONAL
TABLET ARMS & CASTERS

MODEL / DESCRIPTION / LIST PRICING

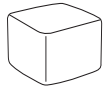

1245NL 18" Almost Square Ottoman No Legs (casters not available) COM Yardage: Total: 2.25 Yds. / Top: .75 Yds. / Sides: 1.5 Yds.

COM	GR1	GR2	GR3	GR4	GR5	GR6	GR7	GR8	GR9	GR10	LEA
\$903	\$1033	\$1164	\$1295	\$1426	\$1557	\$1687	\$1818	\$1949	\$2080	\$2211	\$2336

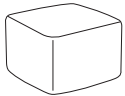

1246NL 24" Almost Square Ottoman No Legs (4 casters needed) COM Yardage: Total: 2.5 Yds. / Top: .75 Yds. / Sides: 1.75 Yds.

COM	GR1	GR2	GR3	GR4	GR5	GR6	GR7	GR8	GR9	GR10	LEA
\$1026	\$1156	\$1287	\$1418	\$1549	\$1680	\$1810	\$1941	\$2072	\$2203	\$2334	\$2459

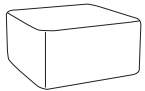

1248NL 30" Almost Square Ottoman No Legs (4 casters needed) COM Yardage: Total: 3.5 Yds. / Top: 1 Yds. / Sides: 2.5 Yds.

COM	GR1	GR2	GR3	GR4	GR5	GR6	GR7	GR8	GR9	GR10	LEA
\$1194	\$1324	\$1455	\$1586	\$1717	\$1848	\$1978	\$2109	\$2240	\$2371	\$2502	\$2627

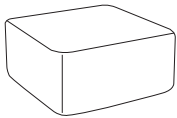

1250NL 36" Almost Square Ottoman No Legs (4 casters needed) COM Yardage: Total: 4 Yds. / Top: 1.25 Yds. / Sides: 2.75 Yds.

COM	GR1	GR2	GR3	GR4	GR5	GR6	GR7	GR8	GR9	GR10	LEA
\$1306	\$1437	\$1567	\$1698	\$1829	\$1960	\$2091	\$2221	\$2352	\$2483	\$2614	\$2739

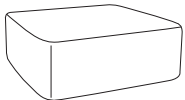

1252NL 42" Almost Square Ottoman No Legs (4 casters needed) COM Yardage: Total: 4.5 Yds. / Top: 1.5 Yds. / Sides: 3 Yds.

COM	GR1	GR2	GR3	GR4	GR5	GR6	GR7	GR8	GR9	GR10	LEA
\$1601	\$1732	\$1863	\$1994	\$2124	\$2255	\$2386	\$2517	\$2648	\$2778	\$2909	\$3035

OPTIONS

Add upcharge to list price and code to model number

FR	CAL 133 (TB 133) Fire Retardant per yard	\$90/yd.
MB	Moisture Barrier - per ottoman	\$125
2FO	Two Fabric Option	\$98
CAS3	Black 3" Casters (not available on 18" size)	\$25 each

TAB-LO	Fixed Tablet Arm (Specify shape A, B, or C)	\$495
LAM5	Non-standard laminate (5 tablets or less)	\$250 ea. tablet
SST	Solid Surface Tablet Arm - add to tablet option	\$125
SS5	Non-standard Solid Surface (5 tablets or less)	Call For Quote

DIMENSIONS	24" Dia	30" Dia	36" Dia	42" Dia
Overall Depth:	24"	30"	36"	42"
Overall Width:	24"	30"	36"	42"
Overall Height:	17"	17"	17"	17"
Qty./Wt.:	1 ea./20 lbs.	1 ea./29 lbs.	1 ea./42 lbs.	1 ea./59 lbs.



30" DIAMETER OCCASIONAL TABLE

Note: All laminate table heights are 17" with edge .75" 4-B with natural stain

MODEL / DESCRIPTION / LIST PRICING

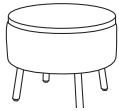

1238/T 24" Diameter Occasional Table (4 Legs)

COM Yardage: Total: 1.5 Yds.

COM	GR1	GR2	GR3	GR4	GR5	GR6	GR7	GR8	GR9	GR10	LEA
\$1488	\$1619	\$1749	\$1880	\$2011	\$2142	\$2273	\$2403	\$2534	\$2665	\$2796	\$2921



1240/T 30" Diameter Occasional Table (4 Legs)

COM Yardage: Total: 1.75 Yds.

COM	GR1	GR2	GR3	GR4	GR5	GR6	GR7	GR8	GR9	GR10	LEA
\$1787	\$1917	\$2048	\$2179	\$2310	\$2441	\$2571	\$2702	\$2833	\$2964	\$3095	\$3220

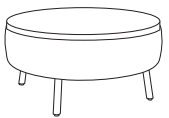

1242/T 36" Diameter Occasional Table (4 Legs)

COM Yardage: Total: 2 Yds.

COM	GR1	GR2	GR3	GR4	GR5	GR6	GR7	GR8	GR9	GR10	LEA
\$1983	\$2114	\$2244	\$2375	\$2506	\$2637	\$2768	\$2898	\$3029	\$3160	\$3291	\$3416

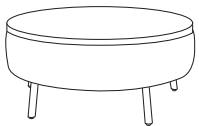

1244/T 42" Diameter Occasional Table (5 Legs)

COM Yardage: Total: 2.25 Yds.

COM	GR1	GR2	GR3	GR4	GR5	GR6	GR7	GR8	GR9	GR10	LEA
\$2490	\$2620	\$2751	\$2882	\$3013	\$3144	\$3274	\$3405	\$3536	\$3667	\$3798	\$3923

OPTIONS

Add upcharge to list price and code to model number

FR	CAL 133 (TB 133) Fire Retardant per yard	\$90/yd.
PC	Polished Chrome Legs	\$35 each

WDL	Metal/Wood Legs	\$35 each
WDL-C	Chrome/Wood Legs	\$60 each

DIMENSIONS	18" Dia	24" Dia	30" Dia	36" Dia	42" Dia
Overall Depth:	18"	24"	30"	36"	42"
Overall Width:	18"	24"	30"	36"	42"
Overall Height:	17"	17"	17"	17"	17"
Qty./Wt.:	1 ea./14 lbs.	1 ea./22 lbs.	1 ea./35 lbs.	1 ea./51 lbs.	1 ea./69 lbs.



ROUND OCCASIONAL TABLE
WITH NO LEGS

Note: glides are installed

Note: All laminate table heights are 17" with edge .75" 4-B with natural stain

MODEL / DESCRIPTION / LIST PRICING



1237NL/T 18" Diameter Occasional Table No Legs (casters not available)

COM Yardage: Total: 1.5 Yds.

COM	GR1	GR2	GR3	GR4	GR5	GR6	GR7	GR8	GR9	GR10	LEA
\$1247	\$1378	\$1509	\$1639	\$1770	\$1901	\$2032	\$2163	\$2293	\$2424	\$2555	\$2680

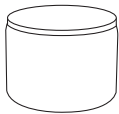

1238NL/T 24" Diameter Occasional Table No Legs (4 casters needed)

COM Yardage: Total: 2 Yds.

COM	GR1	GR2	GR3	GR4	GR5	GR6	GR7	GR8	GR9	GR10	LEA
\$1405	\$1536	\$1667	\$1797	\$1928	\$2059	\$2190	\$2321	\$2451	\$2582	\$2713	\$2838

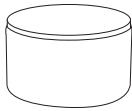

1240NL/T 30" Diameter Occasional Table No Legs (4 casters needed)

COM Yardage: Total: 2.25 Yds.

COM	GR1	GR2	GR3	GR4	GR5	GR6	GR7	GR8	GR9	GR10	LEA
\$1688	\$1819	\$1950	\$2081	\$2212	\$2342	\$2473	\$2604	\$2735	\$2866	\$2996	\$3122



1242NL/T 36" Diameter Occasional Table No Legs (4 casters needed)

COM Yardage: Total: 2.5 Yds.

COM	GR1	GR2	GR3	GR4	GR5	GR6	GR7	GR8	GR9	GR10	LEA
\$1875	\$2006	\$2136	\$2267	\$2398	\$2529	\$2660	\$2790	\$2921	\$3052	\$3183	\$3308

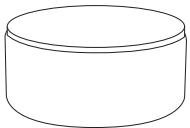

1244NL/T 42" Diameter Occasional Table No Legs (5 casters needed)

COM Yardage: Total: 3 Yds.

COM	GR1	GR2	GR3	GR4	GR5	GR6	GR7	GR8	GR9	GR10	LEA
\$2359	\$2490	\$2620	\$2751	\$2882	\$3013	\$3144	\$3274	\$3405	\$3536	\$3667	\$3792

OPTIONS

Add upcharge to list price and code to model number

FR	CAL 133 (TB 133) Fire Retardant per yard	\$90/yd.	CAS3	Black 3" Casters (not available on 18" size)	\$25 each
----	--	----------	------	--	-----------

DIMENSIONS	24" Square	30" Square	36" Square	42" Square
Overall Depth:	24"	30"	36"	42"
Overall Width:	24"	30"	36"	42"
Overall Height:	17"	17"	17"	17"
Qty./Wt.:	1 ea./24 lbs.	1 ea./37 lbs.	1 ea./54 lbs.	1 ea./75 lbs.



30" ALMOST SQUARE
OCCASIONAL TABLE

Note: All laminate table heights are 17" with edge .75" 4-B with natural stain

MODEL / DESCRIPTION / LIST PRICING



1246/T 24" Almost Square Occasional Table (4 Legs)

COM Yardage: Total: 1 Yds.

COM	GR1	GR2	GR3	GR4	GR5	GR6	GR7	GR8	GR9	GR10	LEA
\$1564	\$1695	\$1826	\$1957	\$2087	\$2218	\$2349	\$2480	\$2611	\$2741	\$2872	\$2998



1248/T 30" Almost Square Occasional Table (4 Legs)

COM Yardage: Total: 1.5 Yds.

COM	GR1	GR2	GR3	GR4	GR5	GR6	GR7	GR8	GR9	GR10	LEA
\$1832	\$1963	\$2094	\$2225	\$2355	\$2486	\$2617	\$2748	\$2879	\$3009	\$3140	\$3266



1250/T 36" Almost Square Occasional Table (4 Legs)

COM Yardage: Total: 1.75 Yds.

COM	GR1	GR2	GR3	GR4	GR5	GR6	GR7	GR8	GR9	GR10	LEA
\$2036	\$2167	\$2298	\$2429	\$2559	\$2690	\$2821	\$2952	\$3083	\$3213	\$3344	\$3469

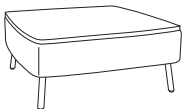

1252/T 42" Almost Square Occasional Table (4 Legs)

COM Yardage: Total: 1.75 Yds.

COM	GR1	GR2	GR3	GR4	GR5	GR6	GR7	GR8	GR9	GR10	LEA
\$2575	\$2705	\$2836	\$2967	\$3098	\$3229	\$3359	\$3490	\$3621	\$3752	\$3883	\$4008

OPTIONS

Add upcharge to list price and code to model number

FR	CAL 133 (TB 133) Fire Retardant per yard	\$90/yd.	WDL	Metal/Wood Legs	\$35 each
PC	Polished Chrome Legs	\$35 each	WDL-C	Chrome/Wood Legs	\$60 each

DIMENSIONS	18" Square	24" Square	30" Square	36" Square	42" Square
Overall Depth:	18"	24"	30"	36"	42"
Overall Width:	18"	24"	30"	36"	42"
Overall Height:	17"	17"	17"	17"	17"
Qty./Wt.:	1 ea./17 lbs.	1 ea./29 lbs.	1 ea./45 lbs.	1 ea./65 lbs.	1 ea./88 lbs.



30" SQUARE OCCASIONAL TABLE
WITH NO LEGS

Note: glides are installed

Note: All laminate table heights are 17" with edge .75" 4-B with natural stain

MODEL / DESCRIPTION / LIST PRICING

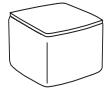

1245NL/T 18" Almost Square Occasional Table - No Legs (casters not available) COM Yardage: Total: 1.5 Yds.

COM	GR1	GR2	GR3	GR4	GR5	GR6	GR7	GR8	GR9	GR10	LEA
\$1328	\$1458	\$1589	\$1720	\$1851	\$1982	\$2112	\$2243	\$2374	\$2505	\$2636	\$2761

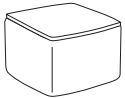

1246NL/T 24" Almost Square Occasional Table - No Legs (4 casters needed) COM Yardage: Total: 1.75 Yds.

COM	GR1	GR2	GR3	GR4	GR5	GR6	GR7	GR8	GR9	GR10	LEA
\$1478	\$1609	\$1740	\$1870	\$2001	\$2132	\$2263	\$2394	\$2524	\$2655	\$2786	\$2911

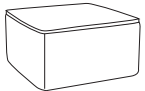

1248NL/T 30" Almost Square Occasional Table - No Legs (4 casters needed) COM Yardage: Total: 2.5 Yds.

COM	GR1	GR2	GR3	GR4	GR5	GR6	GR7	GR8	GR9	GR10	LEA
\$1733	\$1864	\$1995	\$2126	\$2256	\$2387	\$2518	\$2649	\$2780	\$2910	\$3041	\$3166

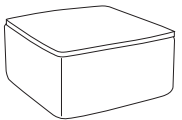

1250NL/T 36" Almost Square Occasional Table - No Legs (4 casters needed) COM Yardage: Total: 2.75 Yds.

COM	GR1	GR2	GR3	GR4	GR5	GR6	GR7	GR8	GR9	GR10	LEA
\$1927	\$2058	\$2189	\$2320	\$2450	\$2581	\$2712	\$2843	\$2974	\$3104	\$3235	\$3360

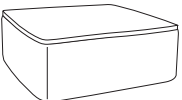

1252NL/T 42" Almost Square Occasional Table - No Legs (4 casters needed) COM Yardage: Total: 3 Yds.

COM	GR1	GR2	GR3	GR4	GR5	GR6	GR7	GR8	GR9	GR10	LEA
\$2441	\$2571	\$2702	\$2833	\$2964	\$3095	\$3225	\$3356	\$3487	\$3618	\$3749	\$3874

OPTIONS

Add upcharge to list price and code to model number

FR	CAL 133 (TB 133) Fire Retardant per yard	\$90/yd.	CAS3	Black 3" Casters (not available on 18" size)	\$25 each
----	--	----------	------	--	-----------

