



RAVEN TABLE OF CONTENTS

Raven Specifications	2
Raven Banquette Options.....	3
Raven Banquette Pricing.....	4
Raven Banquette Privacy Panel Pricing.....	8
Raven Modular Options.....	9
Raven Modular Pricing.....	10
Raven Modular Privacy Panel Pricing.....	14
Raven Backless Units.....	17
Raven Modular Individual Arms	19
Raven Modular Configurations	20
Raven Ottomans.....	22
Raven Benches	25
Raven Lounge Options	26
Raven Lounge Pricing.....	27
Raven Tables & Curios Specifications	28
Raven Tables & Curios Pricing.....	29
Raven Junior.....	31

RAVEN

The Raven series offers an extensive variety of shapes and designs to fit a multitude of areas. The banquettes come in three different back heights, a choice of wood or metal legs or a plinth base, and a variety of privacy panels. The modular units offers straight or curved units to create fun configurations, in any open space. This series also offers ottomans, lounge chairs and is complemented with curio side tables, to adapt to any design you dream up. Designed for higher education and any public space that requires long duration seating with comfort.



BANQUETTE



MODULAR



LOUNGE



OTTOMAN



OCCASIONAL TABLE



CHILDREN'S

ORDERING INFORMATION

- 1) Series Name
- 2) Model Number
- 3) Quantity
- 4) Fabric Grade & Number
- 5) Optional Items / Colors



LOW BACK
27"



STANDARD BACK
33"



HIGH BACK
42"

Available on
Banquette
ONLY

SOFT SEATING	WEIGHT LIMIT
1 Seat	500 lbs.
2 Seat	1000 lbs.
3 Seat	1500 lbs.

RAVEN SPECIFICATIONS

Frame Construction

Frame assembly is constructed of multi-ply hardwood, with tongue and groove construction. All foam is fully bonded to frame. Seat cushions are 4" graded high resiliency (H.R.) block foam with back 3" (H.R.) foam, covered entirely with special bonded polyester fiber to protect final upholstery. No sag-springs are installed in seat & back along with interlocking helicoil springs to prevent sagging and provide additional lower back and seat support.

Upholstery

Seat and back are covered in choice of fabric, vinyl, crypton, leather or COM. ERG uses only water based glues and adhesives in our upholstery process.

Legs

2"RD X 3"H round tubular steel legs are standard and available in standard powder coat colors. Optional polished chrome and wood legs are also available. Legs have a factory installed poly vinyl glide.

Optional Plinth Base (Available only on Banquettes)

The optional base is available in a choice of laminate or unfinished so that you can add your own cover base or carpet.

Anchoring

Raven Banquettes are easy to anchor to the floor. Floor mount instructions can be provided by customer service. Hardware for anchoring bench to the floor is not included.

*Raven Banquette
Available in 3 heights
27", 33" or 42"*

OPTIONS

- CODE: FR - CAL 133 (TB 133) Fire Retardant
- CODE: MB -Moisture Barrier (up to 60" overall width)
- CODE: MB60 -Moisture Barrier (over 60" overall width)
- CODE: MBB -Moisture Barrier (up to 60" overall width Back-to-Back)
- CODE: MBB60 -Moisture Barrier (over 60" overall width Back-to-Back)
- CODE: LOW - Fully Upholstered Low Back - 27" OA Height
- CODE: WOD - Wood Legs
- CODE: PC - Polished Chrome Legs
- CODE: CAS3 - 3" Casters
- CODE: 2FO - Two Fabric Option
- CODE: GD - Ganging Device for metal/wood legs
(Necessary when ganging two or more modules together)
- CODE: GBP - Ganging Brackets For Plinth Base
- CODE: CO - Clean Out (overall width up to 50")
- CODE: CO1 - Clean Out (overall width over 50")
- CODE: COB - Clean Out Back-to-Back (overall width up to 50")
- CODE: CO1B - Clean Out Back-to-Back (overall width over 50")
- CODE: FM - Floor Mount Tabs
- CODE: PB48 - Plinth Base - up to 48"
- CODE: PB72 - Plinth Base - 49" to 72"
- CODE: PB48B - Plinth Base - up to 48" back-to-back
- CODE: PB72B - Plinth Base - 49" to 72" back-to-back
- CODE: UFB - Unfinished Plinth Base
- CODE: RB1 - Recessed Plinth Base (1 Side only)
- CODE: RB2 - Recessed Plinth Base (2 Sides)



POLISHED CHROME LEGS



WOOD LEGS



TWO FABRIC OPTION



CLEANOUT

PLINTH BASE

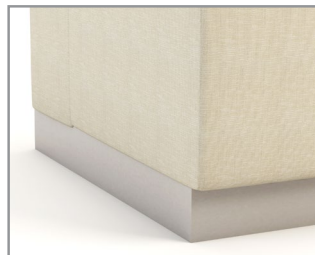

BANQUETTE COMES STANDARD WITH FLUSH SIDES FOR GANGING AND RECESSED FRONT

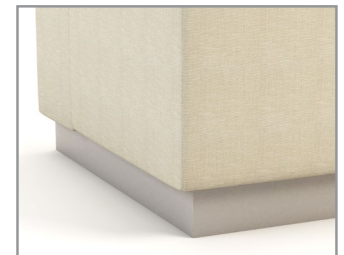

BANQUETTE HAS OPTIONAL RECESSED PLINTH BASE ON ONE OR TWO SIDES

DIMENSIONS	Straight Banquette
Seat Depth:	20"
Seat Height:	18"
Overall Depth:	27"
Overall Width:	48, 60, 72"
Overall Height:	33"
Qty./Wt.:	1 ea./150 lbs.



RAVEN BANQUETTE WITH
OPTIONAL PLINTH BASE AND
POWER/DATA UNIT

MODEL / DESCRIPTION / LIST PRICING

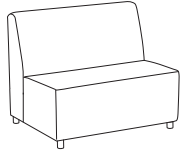

8372 48"W Straight Banquette (4 legs)

COM Yardage: Total: 6.5 Yds. / Back: 4 Yds. / Seat: 2.5 Yds.

COM	GR1	GR2	GR3	GR4	GR5	GR6	GR7	GR8	GR9	GR10	LEA
\$2000	\$2151	\$2300	\$2449	\$2600	\$2749	\$2899	\$3049	\$3199	\$3348	\$3499	\$3643

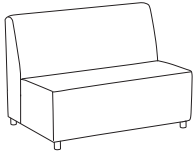

8374 60"W Straight Banquette (4 legs)

COM Yardage: Total: 9 Yds. / Back: 5 Yds. / Seat: 4 Yds.

COM	GR1	GR2	GR3	GR4	GR5	GR6	GR7	GR8	GR9	GR10	LEA
\$2500	\$2688	\$2874	\$3062	\$3249	\$3437	\$3624	\$3812	\$3998	\$4186	\$4373	\$4553

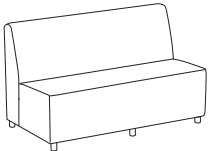

8376 72"W Straight Banquette (6 legs)

COM Yardage: Total: 11 Yds. / Back: 6 Yds. / Seat: 5 Yds.

COM	GR1	GR2	GR3	GR4	GR5	GR6	GR7	GR8	GR9	GR10	LEA
\$3001	\$3225	\$3450	\$3674	\$3899	\$4125	\$4349	\$4574	\$4798	\$5023	\$5248	\$5464

OPTIONS

Add upcharge to list price and code to model number

FR	CAL 133 (TB 133) Fire Retardant per yard	\$90/yd.
MB	Moisture Barrier - up to 60" width	\$125 each
MB60	Moisture Barrier - over 60" width	\$200 each
LOW	Fully Upholstered Low Back - 27" OA Height	\$95 per unit
WOD	Wood Legs	\$24 ea.
PC	Polished Chrome Legs	\$25 ea.
CAS3	3" Casters	\$25 ea.
2FO	Two Fabric Option	\$98
GD	Ganging Device for Metal/Wood Legs	\$52

GBP	Ganging Bracket for Plinth Base	\$110
CO	Clean Out (overall width up to 50")	\$250
CO1	Clean Out (overall width over 50")	\$385
FM	Floor Mount	\$98
PB48	Plinth Base - Up To 48"	\$190
PB72	Plinth Base - 49" to 72"	\$320
UFB	Unfinished Plinth Base (deduct from plinth option)	Deduct \$80
RB1	Recessed Base, 1 side	\$110
RB2	Recessed Base, 2 sides	\$220

DIMENSIONS	Back-to-Back Banquette
Seat Depth:	20"
Seat Height:	18"
Overall Depth:	52"
Overall Width:	48, 60, 72"
Overall Height:	33"
Qty./Wt.:	1 ea./280 lbs.



BACK-TO-BACK BANQUETTE
WITH OPTIONAL CLEANOUT

MODEL / DESCRIPTION / LIST PRICING



8380 48"W Back-to-Back Banquette (6 legs)

COM Yardage: Total: 8 Yds. / Back: 3 Yds. / Seat: 5 Yds.

COM	GR1	GR2	GR3	GR4	GR5	GR6	GR7	GR8	GR9	GR10	LEA
\$3801	\$4086	\$4370	\$4653	\$4940	\$5223	\$5509	\$5792	\$6079	\$6362	\$6648	\$6922



8382 60"W Back-to-Back Banquette (6 legs)

COM Yardage: Total: 11 Yds. / Back: 5 Yds. / Seat: 6 Yds.

COM	GR1	GR2	GR3	GR4	GR5	GR6	GR7	GR8	GR9	GR10	LEA
\$4751	\$5107	\$5461	\$5817	\$6174	\$6530	\$6887	\$7242	\$7596	\$7953	\$8309	\$8650

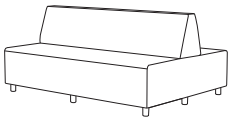

8384 72"W Back-to-Back Banquette (8 legs)

COM Yardage: Total: 13 Yds. / Back: 6 Yds. / Seat: 7 Yds.

COM	GR1	GR2	GR3	GR4	GR5	GR6	GR7	GR8	GR9	GR10	LEA
\$5702	\$6128	\$6555	\$6981	\$7408	\$7837	\$8263	\$8689	\$9117	\$9543	\$9972	\$10382

Note: To order Back to Back banquettes with privacy panel, the order will consist of two single straight units and privacy panel. The overall depth of these combined units with panel is 55". See page 8 for panel specs.

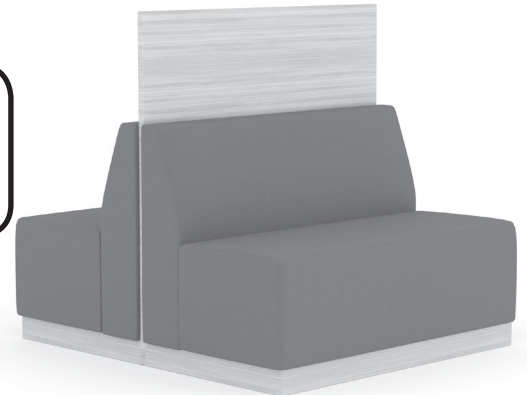

OPTIONS

Add upcharge to list price and code to model number

FR	CAL 133 (TB 133) Fire Retardant per yard	\$90/yd.
MBB	Moisture Barrier - up to 60" width (Back-to-Back)	\$250 ea.
MBB60	Moisture Barrier - over 60" width (Back-to-Back)	\$400 ea.
LOW	Fully Upholstered Low Back - 27" OA Height	\$95 per unit
WOD	Wood Legs	\$24 ea.
PC	Polished Chrome Legs	\$25 ea.
CAS3	3" Casters	\$25 ea.
2FO	Two Fabric Option	\$98
GD	Ganging Device for Metal/Wood Legs	\$52

GBP	Ganging Bracket for Plinth Base	\$110
COB	Clean Out Back-to-Back (overall width up to 50")	\$500
CO1B	Clean Out Back-to-Back (overall width over 50")	\$770
FM	Floor Mount	\$98
PB48B	Plinth Base - Up To 48" Back-To-Back	\$290
PB72B	Plinth Base - 49" to 72" Back-To-Back	\$440
UFB	Unfinished Plinth Base (deduct from plinth option)	Deduct \$80
RB1	Recessed Base, 1 side	\$110
RB2	Recessed Base, 2 sides	\$220

DIMENSIONS	Straight Banquette
Seat Depth:	20"
Seat Height:	18"
Overall Depth:	28.5"
Overall Width:	48, 60, 72"
Overall Height:	42"
Qty./Wt.:	1 ea./150 lbs.

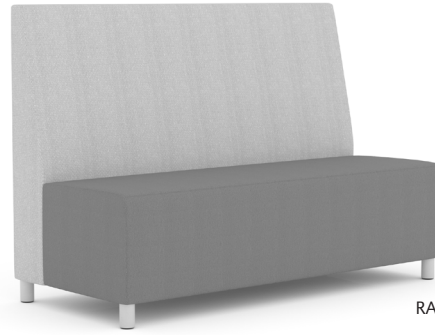

RAVEN HIGH BACK BANQUETTE
WITH TWO FABRICS

MODEL / DESCRIPTION / LIST PRICING



8372HB 48"W Straight High Back Banquette (4 legs)

COM Yardage: Total: 7.5 Yds. / Back: 4.5 Yds. / Seat: 3 Yds.

COM	GR1	GR2	GR3	GR4	GR5	GR6	GR7	GR8	GR9	GR10	LEA
\$3044	\$3257	\$3388	\$3523	\$3663	\$3811	\$3963	\$4121	\$4287	\$4458	\$4636	\$5481

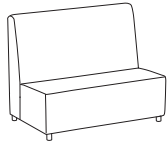

8374HB 60"W Straight High Back Banquette (4 legs)

COM Yardage: Total: 9.5 Yds. / Back: 5.5 Yds. / Seat: 4 Yds.

COM	GR1	GR2	GR3	GR4	GR5	GR6	GR7	GR8	GR9	GR10	LEA
\$3745	\$4008	\$4167	\$4335	\$4508	\$4688	\$4876	\$5071	\$5273	\$5484	\$5704	\$6742

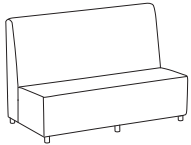

8376HB 72"W Straight High Back Banquette (6 legs)

COM Yardage: Total: 11.5 Yds. / Back: 6.5 Yds. / Seat: 5 Yds.

COM	GR1	GR2	GR3	GR4	GR5	GR6	GR7	GR8	GR9	GR10	LEA
\$4445	\$4757	\$4946	\$5145	\$5351	\$5564	\$5787	\$6019	\$6260	\$6509	\$6770	\$8002

OPTIONS

Add upcharge to list price and code to model number

FR	CAL 133 (TB 133) Fire Retardant per yard	\$90/yd.
MB	Moisture Barrier - up to 60" width	\$125 ea.
MB60	Moisture Barrier - over 60" width	\$200 ea.
WOD	Wood Legs	\$24 ea.
PC	Polished Chrome Legs	\$25 ea.
CAS3	3" Casters	\$25 ea.
2FO	Two Fabric Option	\$98
GD	Ganging Device for Metal/Wood Legs	\$52
GBP	Ganging Bracket for Plinth Base	\$110

CO	Clean Out (overall width up to 50")	\$250
CO1	Clean Out (overall width over 50")	\$385
FM	Floor Mount	\$98
PB48	Plinth Base - Up To 48"	\$190
PB72	Plinth Base - 49" to 72"	\$320
UFB	Unfinished Plinth Base (deduct from plinth option)	Deduct \$80
RB1	Recessed Base, 1 side	\$110
RB2	Recessed Base, 2 sides	\$220

DIMENSIONS	Back-to-Back Banquette
Seat Depth:	20"
Seat Height:	18"
Overall Depth:	52"
Overall Width:	22, 48, 60, 72"
Overall Height:	42"
Qty./Wt.:	1 ea./290 lbs.



60" RAVEN BACK-TO-BACK
HIGH BACK BANQUETTE

MODEL / DESCRIPTION / LIST PRICING



8380HB 48"W Back-to-Back High Back Banquette (6 legs)

COM Yardage: Total: 9 Yds. / Back: 4 Yds. / Seat: 5 Yds.

COM	GR1	GR2	GR3	GR4	GR5	GR6	GR7	GR8	GR9	GR10	LEA
\$5785	\$6189	\$6436	\$6694	\$6962	\$7241	\$7531	\$7831	\$8144	\$8470	\$8808	\$10412

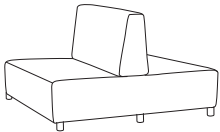

8382HB 60" W Back-to-Back High Back Banquette (6 legs)

COM Yardage: Total: 12 Yds. / Back: 6 Yds. / Seat: 6 Yds.

COM	GR1	GR2	GR3	GR4	GR5	GR6	GR7	GR8	GR9	GR10	LEA
\$7117	\$7614	\$7918	\$8236	\$8565	\$8909	\$9263	\$9635	\$10020	\$10419	\$10838	\$12809

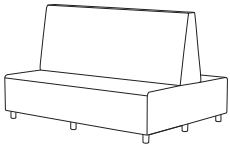

8384HB 72" W Back-to-Back High Back Banquette (8 legs)

COM Yardage: Total: 14 Yds. / Back: 7 Yds. / Seat: 7 Yds.

COM	GR1	GR2	GR3	GR4	GR5	GR6	GR7	GR8	GR9	GR10	LEA
\$8446	\$9037	\$9399	\$9776	\$10166	\$10572	\$10996	\$11435	\$11893	\$12368	\$12862	\$15203

OPTIONS

Add upcharge to list price and code to model number

FR	CAL 133 (TB 133) Fire Retardant per yard	\$90/yd.
MBB	Moisture Barrier - up to 60" width (Back-to-Back)	\$250 ea.
MBB60	Moisture Barrier - over 60" width (Back-to-Back)	\$400 ea.
WOD	Wood Legs	\$24 ea.
PC	Polished Chrome Legs	\$25 ea.
CAS3	3" Casters	\$25 ea.
2FO	Two Fabric Option	\$98
GD	Ganging Device for Metal/Wood Legs	\$52
GBP	Ganging Bracket for Plinth Base	\$110

COB	Clean Out Back-to-Back (overall width up to 50")	\$500
CO1B	Clean Out Back-to-Back (overall width over 50")	\$770
FM	Floor Mount	\$98
PB48B	Plinth Base - Up To 48" Back-To-Back	\$290
PB72B	Plinth Base - 49" to 72" Back-To-Back	\$440
UFB	Unfinished Plinth Base (deduct from plinth option)	Deduct \$80
RB1	Recessed Base, 1 side	\$110
RB2	Recessed Base, 2 sides	\$220

PRIVACY PANELS ONLY

DIMENSIONS	48" Wide Privacy Panel	60" Wide Privacy Panel	72" Wide Privacy Panel
Panel Depth:	1"	1"	1"
Panel Width:	48"	60"	72"
Panel Height:	48"	48"	48"



RAVEN BACK TO BACK BANQUETTE WITH PRIVACY PANEL



1/2" THICK ACRYLIC PRIVACY PANELS AVAILABLE

MODEL / DESCRIPTION / LIST PRICING

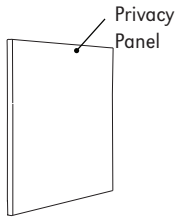

360P 48" Wide Privacy Panel COM Yardage: Total: 3 Yds.

COM	GR1	GR2	GR3	GR4	GR5	GR6	GR7	GR8	GR9	GR10	LEA
\$948	\$1015	\$1055	\$1098	\$1141	\$1187	\$1234	\$1283	\$1334	\$1389	\$1443	\$1706
LAMINATE			VENEER			ACRYLIC					
\$929			\$1827			CALL					

362P 60" Wide Privacy Panel COM Yardage: Total: 4 Yds.

COM	GR1	GR2	GR3	GR4	GR5	GR6	GR7	GR8	GR9	GR10	LEA
\$1250	\$1339	\$1391	\$1448	\$1505	\$1565	\$1627	\$1693	\$1760	\$1831	\$1904	\$2251
LAMINATE			VENEER			ACRYLIC					
\$1214			\$2350			CALL					

365P 72" Wide Privacy Panel COM Yardage: Total: 5 Yds.

COM	GR1	GR2	GR3	GR4	GR5	GR6	GR7	GR8	GR9	GR10	LEA
\$1531	\$1638	\$1704	\$1772	\$1843	\$1916	\$1993	\$2073	\$2156	\$2242	\$2330	\$2756
LAMINATE			VENEER			ACRYLIC					
\$1477			\$2759			CALL					

Note: For laminate privacy panels, 3MM PVC or laminate self edges are available.

OPTIONS

- CODE: FR - CAL 133 (TB 133) Fire Retardant
- CODE: MB - Moisture Barrier (up to 60" overall width)
- CODE: MB60 - Moisture Barrier (over 60" overall width)
- CODE: LOW - Fully Upholstered Low Back - 27" OA Height
- CODE: WOD - Wood Legs
- CODE: WAC - Wood Arm Caps
- CODE: PAC - Poly Arm Caps - Standard Black/Charcoal
- CODE: PC - Polished Chrome Legs
- CODE: CAS3 - 3" Casters
- CODE: CO - Clean Out (overall width up to 50")
- CODE: CO1 - Clean Out (overall width over 50")
- CODE: 2FO - Two Fabric Option
- CODE: GD - Ganging Device for metal/wood legs
(Necessary when ganging two or more modules together)
- CODE: TABF(-) - Fixed Laminate Tablet - outside of modular unit
(round post, specify tablet shape A, B or C)
- CODE: TABFB(-) - Fixed Laminate Tablet - between two modular units
(blade post, specify tablet shape A, B or C)
- CODE: TABR1(-) - Removable Swivel Tablet (laminate shape A, B or C specify
left or right arm)
- CODE: TABR2(-) - Removable Swivel Tablet (laminate shape A, B or C with
opening for tablet on both arms)
- CODE: LAM5 - Non-standard laminate for 5 or less tablets
see options for upcharge
- CODE: SST - Solid Surface Tablet
- CODE: SS5 - Non-standard Solid Surface top for 5 or less tablets



LOW-BACK

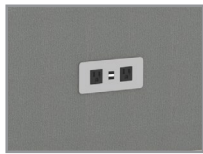

POWER/DATA

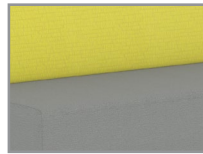

TWO FABRICS



LAMINATE TABLET OR
OPTIONAL SOLID SURFACE



CLEANOUT



CASTERS



WOOD LEGS



POLISHED CHROME LEGS



TABLET SHAPES

Choose from 3 Tablet Shapes:

Tablets for all modular series are available in 3 shapes, choose from the three shapes shown and specify; A, B or C and left or right (outside tablet) when ordering. Example: TABF-(A) Left - this would be a fixed shape A tablet on the left side (when seated).

Optional Solid Surface available.

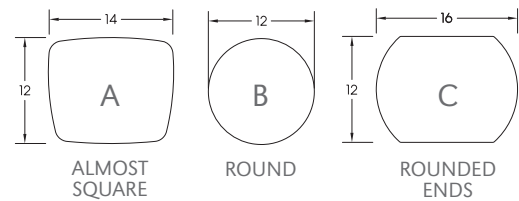

Tablet orders of 5 or less:

3 standard laminate colors:

Wilsonart Black 1595-60, Formica Brite White 459-58 or Nevamar Silver Alu Metalx MXT003.

4 standard Corian colors:

Bone, Bronzite, Glacier White, and Silver Grey.

DIMENSIONS	22" Straight Unit	30" Straight Unit	44" Straight Unit
Seat Depth:	20"	20"	20"
Seat Height:	18"	18"	18"
Overall Depth:	27"	27"	27"
Overall Width:	22"	30"	44"
Overall Height:	33"	33"	33"
Qty./Wt.:	1 ea./44 lbs.	1 ea./44 lbs.	1 ea./44 lbs.



STRAIGHT UNITS - TABLET ARM AND ELECTRICAL OPTIONS

MODEL / DESCRIPTION / LIST PRICING

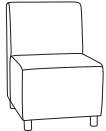

8302 22" W Straight Unit (4 legs)

COM Yardage: Total: 4 Yds. / Back: 2 Yds. / Seat: 2 Yds.

COM	GR1	GR2	GR3	GR4	GR5	GR6	GR7	GR8	GR9	GR10	LEA
\$1105	\$1186	\$1265	\$1357	\$1438	\$1529	\$1621	\$1712	\$1804	\$1896	\$1987	\$2119



8304 30" W Straight Unit (4 legs)

COM Yardage: Total: 5.25 Yds. / Back: 2.5 Yds. / Seat: 2.75 Yds.

COM	GR1	GR2	GR3	GR4	GR5	GR6	GR7	GR8	GR9	GR10	LEA
\$1295	\$1392	\$1494	\$1609	\$1712	\$1827	\$1941	\$2056	\$2170	\$2285	\$2422	\$2554

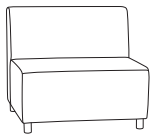

8306 44" W Straight Unit (4 legs)

COM Yardage: Total: 7 Yds. / Back: 4 Yds. / Seat: 3 Yds.

COM	GR1	GR2	GR3	GR4	GR5	GR6	GR7	GR8	GR9	GR10	LEA
\$1833	\$1971	\$2108	\$2245	\$2383	\$2520	\$2657	\$2795	\$2932	\$3069	\$3207	\$3339

OPTIONS

Add upcharge to list price and code to model number

FR	CAL 133 (TB 133) Fire Retardant per yard	\$90/yd.
MB	Moisture Barrier - up to 60" width	\$125 ea.
MB60	Moisture Barrier - over 60" width	\$200 ea.
LOW	Fully Upholstered Low Back - 27" OA Height	\$95
WOD	Wood Legs	\$24 ea.
PC	Polished Chrome Legs	\$25 ea.
CAS3	3" Casters	\$25 ea.
2FO	Two Fabric Option	\$98

GD	Ganging Device for Metal/Wood Legs	\$52
TABF-(L)	Fixed Tablet (outside, specify (L/R), shape A, B or C)	\$370
TABFB-(L)	Fixed Tablet (blade, specify (L/R), shape A, B or C)	\$370
LAM5	Non-standard laminate (5 tablets or less)	\$250 ea. tablet
SST	Solid Surface Tablet Arm - add to tablet option	\$125
SS5	Non-standard Solid Surface (5 tablets or less)	Call For Quote
CO	Clean Out (overall width up to 50")	\$250
CO1	Clean Out (overall width over 50")	\$385

DIMENSIONS	30° Curve Inside	45° Curve Inside	60° Curve Inside
Seat Depth:	20"	20"	20"
Seat Height:	18"	18"	18"
Overall Depth:	29"	30.5"	32.5"
Overall Width:	35"	52"	67"
Overall Height:	33"	33"	33"
Qty./Wt.:	1 ea./64 lbs.	1 ea./84 lbs.	1 ea./115 lbs.



60° Inside Curve with Optional Power/Data Unit

MODEL / DESCRIPTION / LIST PRICING

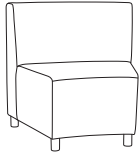

8308 Inside 30° Curve Unit (4 legs)

COM Yardage: Total: 5.25 Yds. / Back: 2.75 Yds. / Seat: 2.5 Yds.

COM	GR1	GR2	GR3	GR4	GR5	GR6	GR7	GR8	GR9	GR10	LEA
\$1202	\$1282	\$1363	\$1454	\$1534	\$1625	\$1717	\$1808	\$1900	\$1991	\$2083	\$2215

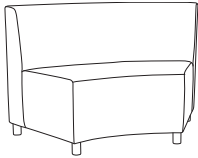

8310 Inside 45° Curve Unit (4 legs)

COM Yardage: Total: 6 Yds. / Back: 3 Yds. / Seat: 3 Yds.

COM	GR1	GR2	GR3	GR4	GR5	GR6	GR7	GR8	GR9	GR10	LEA
\$1766	\$1880	\$1995	\$2121	\$2236	\$2361	\$2487	\$2613	\$2739	\$2865	\$2991	\$3122

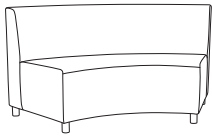

8318 Inside 60° Curve Unit (5 legs)

COM Yardage: Total: 9 Yds. / Back: 5 Yds. / Seat: 4 Yds.

COM	GR1	GR2	GR3	GR4	GR5	GR6	GR7	GR8	GR9	GR10	LEA
\$2296	\$2410	\$2524	\$2651	\$2765	\$2891	\$3017	\$3142	\$3269	\$3394	\$3521	\$3653

OPTIONS

Add upcharge to list price and code to model number

FR	CAL 133 (TB 133) Fire Retardant per yard	\$90/yd.
MB	Moisture Barrier - up to 60" width	\$125 ea.
MB60	Moisture Barrier - over 60" width	\$200 ea.
LOW	Fully Upholstered Low Back - 27" OA Height	\$95
WOD	Wood Legs	\$24 ea.
PC	Polished Chrome Legs	\$25 ea.
CAS3	3" Casters	\$25 ea.
2FO	Two Fabric Option	\$98

GD	Ganging Device for Metal/Wood Legs	\$52
TABF(-)	Fixed Tablet (outside, specify (L/R), shape A, B or C)	\$370
TABFB(-)	Fixed Tablet (blade, specify (L/R), shape A, B or C)	\$370
LAM5	Non-standard laminate (5 tablets or less)	\$250 ea. tablet
SST	Solid Surface Tablet Arm - add to tablet option	\$125
SS5	Non-standard Solid Surface (5 tablets or less)	Call For Quote
CO	Clean Out (overall width up to 50")	\$250
CO1	Clean Out (overall width over 50")	\$385

DIMENSIONS	20° Curve Outside	30° Curve Outside	45° Curve Outside	60° Curve Outside
Seat Depth:	20"	20"	20"	20"
Seat Height:	18"	18"	18"	18"
Overall Depth:	27"	29"	30.5"	32.5"
Overall Width:	23"	35"	52"	67"
Overall Height:	33"	33"	33"	33"
Qty./Wt.:	1 ea./44 lbs.	1 ea./64 lbs.	1 ea./85 lbs.	1 ea./110 lbs.



60 DEGREE OUTSIDE CURVE

MODEL / DESCRIPTION / LIST PRICING

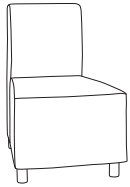

8312 Outside 20° Curve Unit (4 legs)

COM Yardage: Total: 4.5 Yds. / Back: 2 Yds. / Seat: 2.5 Yds.

COM	GR1	GR2	GR3	GR4	GR5	GR6	GR7	GR8	GR9	GR10	LEA
\$1256	\$1347	\$1427	\$1518	\$1599	\$1691	\$1782	\$1874	\$1965	\$2057	\$2148	\$2280

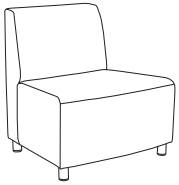

8314 Outside 30° Curve Unit (4 legs)

COM Yardage: Total: 5 Yds. / Back: 2 Yds. / Seat: 3 Yds.

COM	GR1	GR2	GR3	GR4	GR5	GR6	GR7	GR8	GR9	GR10	LEA
\$1343	\$1434	\$1514	\$1606	\$1686	\$1778	\$1869	\$1961	\$2052	\$2144	\$2236	\$2366

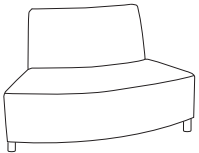

8316 Outside 45° Curve Unit (4 legs)

COM Yardage: Total: 7 Yds. / Back: 3 Yds. / Seat: 4 Yds.

COM	GR1	GR2	GR3	GR4	GR5	GR6	GR7	GR8	GR9	GR10	LEA
\$1973	\$2087	\$2202	\$2328	\$2443	\$2568	\$2694	\$2820	\$2946	\$3072	\$3198	\$3329

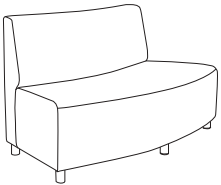

8320 Outside 60° Curve Unit (5 legs)

COM Yardage: Total: 8 Yds. / Back: 3.5 Yds. / Seat: 4.5 Yds.

COM	GR1	GR2	GR3	GR4	GR5	GR6	GR7	GR8	GR9	GR10	LEA
\$2353	\$2479	\$2593	\$2720	\$2834	\$2959	\$3086	\$3211	\$3338	\$3463	\$3589	\$3721

OPTIONS

Add upcharge to list price and code to model number

FR	CAL 133 (TB 133) Fire Retardant per yard	\$90/yd.
MB	Moisture Barrier - up to 60" width	\$125 ea.
MB60	Moisture Barrier - over 60" width	\$200 ea.
LOW	Fully Upholstered Low Back - 27" OA Height	\$95
WOD	Wood Legs	\$24 ea.
PC	Polished Chrome Legs	\$25 ea.
CAS3	3" Casters	\$25 ea.
2FO	Two Fabric Option	\$98

GD	Ganging Device for Metal/Wood Legs	\$52
TABF-(_)	Fixed Tablet (outside, specify (L/R), shape A, B or C)	\$370
TABFB-(_)	Fixed Tablet (blade, specify (L/R), shape A, B or C)	\$370
LAM5	Non-standard laminate (5 tablets or less)	\$250 ea. tablet
SST	Solid Surface Tablet Arm - add to tablet option	\$125
SS5	Non-standard Solid Surface (5 tablets or less)	Call For Quote
CO	Clean Out (overall width up to 50")	\$250
CO1	Clean Out (overall width over 50")	\$385

DIMENSIONS	Corner Units
Seat Depth:	21"
Seat Height:	18"
Overall Depth:	28"
Overall Width:	28"
Overall Height:	33"
Qty./Wt.:	1 ea./75 lbs.



CORNER UNIT – SQUARE SEAT BACK

MODEL / DESCRIPTION / LIST PRICING



8386 Corner Unit – Square Seat Back (4 legs) COM Yardage: Total: 6.5 Yds. / Back: 4.5 Yds. / Seat: 2 Yds.

COM	GR1	GR2	GR3	GR4	GR5	GR6	GR7	GR8	GR9	GR10	LEA
\$2128	\$2276	\$2367	\$2461	\$2559	\$2662	\$2769	\$2880	\$2995	\$3115	\$3239	\$3828



8388 Corner Unit – Curved Seat Back (4 legs) COM Yardage: Total: 6.5 Yds. / Back: 4.5 Yds. / Seat: 2 Yds.

COM	GR1	GR2	GR3	GR4	GR5	GR6	GR7	GR8	GR9	GR10	LEA
\$2218	\$2373	\$2468	\$2566	\$2669	\$2776	\$2887	\$3003	\$3123	\$3247	\$3378	\$3992

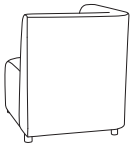

8389 Corner Unit – Curved Back Panel Corner Unit (4 legs) COM Yardage: Total: 6.5 Yds. / Back: 4.5 Yds. / Seat: 2 Yds.

COM	GR1	GR2	GR3	GR4	GR5	GR6	GR7	GR8	GR9	GR10	LEA
\$2385	\$2552	\$2653	\$2760	\$2871	\$2986	\$3104	\$3230	\$3357	\$3492	\$3632	\$4292

OPTIONS

Add upcharge to list price and code to model number

FR	CAL 133 (TB 133) Fire Retardant per yard	\$90/yd.
MB	Moisture Barrier - up to 60" width	\$125 ea.
MB60	Moisture Barrier - over 60" width	\$200 ea.
LOW	Fully Upholstered Low Back - 27" OA Height	\$95
WOD	Wood Legs	\$24 ea.
PC	Polished Chrome Legs	\$25 ea.

CAS3	3" Casters	\$25 ea.
2FO	Two Fabric Option	\$98
GD	Ganging Device for Metal/Wood Legs	\$52
CO	Clean Out (overall width up to 50")	\$250
CO1	Clean Out (overall width over 50")	\$385

DIMENSIONS	Straight Unit	Straight Unit	Straight Unit
Panel Depth:	1"	1"	1"
Overall Width:	22"	30"	44"
Overall Height:	48"	48"	48"
Qty./Approx Wt.:	1 ea./100 lbs.	1 ea./110 lbs.	1 ea./120 lbs.



STRAIGHT UNIT

MODEL / DESCRIPTION / LIST PRICING

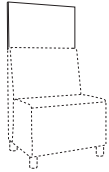

8302P/U	22"W Straight Unit										COM Yardage: 1.5 Yds.		
COM	GR1	GR2	GR3	GR4	GR5	GR6	GR7	GR8	GR9	GR10	LEA		
\$645	\$691	\$718	\$747	\$777	\$807	\$839	\$873	\$909	\$945	\$982	\$1161		
8302P/L	Laminate					8302P/A							Acrylic
	Laminate												Acrylic
	\$791												CALL

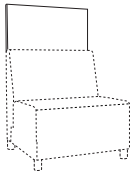

8304P/U	30"W Straight Unit										COM Yardage: 2 Yds.		
COM	GR1	GR2	GR3	GR4	GR5	GR6	GR7	GR8	GR9	GR10	LEA		
\$800	\$856	\$889	\$925	\$962	\$1002	\$1041	\$1082	\$1126	\$1172	\$1219	\$1440		
8304P/L	Laminate					8304P/A							Acrylic
	Laminate												Acrylic
	\$960												CALL

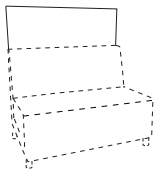

8306P/U	44"W Straight Unit										COM Yardage: 3 Yds.		
COM	GR1	GR2	GR3	GR4	GR5	GR6	GR7	GR8	GR9	GR10	LEA		
\$919	\$983	\$1021	\$1064	\$1105	\$1150	\$1196	\$1244	\$1294	\$1345	\$1400	\$1654		
8306P/L	Laminate					8306P/A							Acrylic
	Laminate												Acrylic
	\$1106												CALL

OPTIONS

Add upcharge to list price and code to model number

FR	CAL 133 (TB 133) Fire Retardant per yard	\$90/yd.
----	--	----------

DIMENSIONS	30° Curve Inside	45° Curve Inside	60° Curve Inside
Panel Depth:	1"	1"	1"
Overall Width:	35"	52"	67"
Overall Height:	48"	48"	48"
Qty./Approx Wt.:	1 ea./135 lbs.	1 ea./145 lbs.	1 ea./160 lbs.

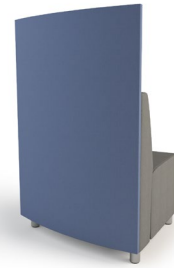

INSIDE CURVE UNIT

MODEL / DESCRIPTION / LIST PRICING

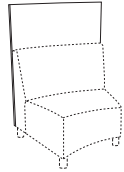

8308P/U Inside 30° Curve Unit COM Yardage: 2 Yds.

COM	GR1	GR2	GR3	GR4	GR5	GR6	GR7	GR8	GR9	GR10	LEA
\$1198	\$1282	\$1333	\$1386	\$1441	\$1499	\$1560	\$1622	\$1687	\$1754	\$1824	\$2156

8308P/L Laminate

Laminate
\$1570

8308P/A Acrylic

Acrylic
CALL

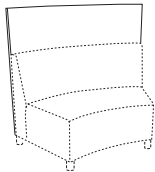

8310P/U Inside 45° Curve Unit COM Yardage: 3 Yds.

COM	GR1	GR2	GR3	GR4	GR5	GR6	GR7	GR8	GR9	GR10	LEA
\$1378	\$1474	\$1534	\$1595	\$1658	\$1724	\$1794	\$1866	\$1940	\$2018	\$2098	\$2480

8310P/L Laminate

Laminate
\$1806

8310P/A Acrylic

Acrylic
CALL

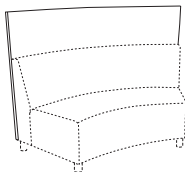

8318P/U Inside 60° Curve Unit COM Yardage: 4 Yds.

COM	GR1	GR2	GR3	GR4	GR5	GR6	GR7	GR8	GR9	GR10	LEA
\$2151	\$2302	\$2394	\$2490	\$2589	\$2693	\$2800	\$2912	\$3029	\$3150	\$3275	\$3872

8318P/L Laminate

Laminate
\$2814

8302P/A Acrylic

Acrylic
CALL

OPTIONS

Add upcharge to list price and code to model number

FR	CAL 133 (TB 133) Fire Retardant per yard	\$90/yd.
----	--	----------

DIMENSIONS	20° Curve Outside	30° Curve Outside	45° Curve Outside	60° Curve Outside
Panel Depth:	1"	1"	1"	1"
Overall Width:	22"	35"	52"	67"
Overall Height:	48"	48"	48"	48"
Qty./Approx Wt.:	1 ea./120 lbs.	1 ea./135 lbs.	1 ea./145 lbs.	1 ea./160 lbs.



OUTSIDE CURVE UNIT

MODEL / DESCRIPTION / LIST PRICING

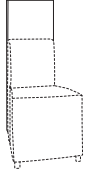

8312P/U Outside 20° Curve Unit COM Yardage: 1.5 Yds.

COM	GR1	GR2	GR3	GR4	GR5	GR6	GR7	GR8	GR9	GR10	LEA
\$838	\$897	\$933	\$970	\$1008	\$1050	\$1091	\$1135	\$1179	\$1227	\$1277	\$1509

8312P/L Laminate

Laminate
\$1099

8312P/A Acrylic

Acrylic
CALL

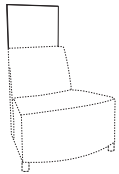

8314P/U Outside 30° Curve Unit COM Yardage: 2 Yds.

COM	GR1	GR2	GR3	GR4	GR5	GR6	GR7	GR8	GR9	GR10	LEA
\$1198	\$1282	\$1333	\$1386	\$1441	\$1499	\$1560	\$1622	\$1687	\$1754	\$1824	\$2156

8314P/L Laminate

Laminate
\$1570

8314P/A Acrylic

Acrylic
CALL

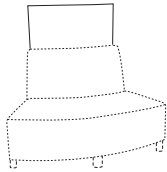

8316P/U Outside 45° Curve Unit COM Yardage: 2 Yds.

COM	GR1	GR2	GR3	GR4	GR5	GR6	GR7	GR8	GR9	GR10	LEA
\$1378	\$1474	\$1534	\$1595	\$1658	\$1724	\$1794	\$1866	\$1940	\$2018	\$2098	\$2480

8316P/L Laminate

Laminate
\$1806

8316P/A Acrylic

Acrylic
CALL

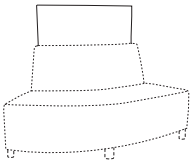

8320P/U Outside 60° Curve Unit COM Yardage: 3 Yds.

COM	GR1	GR2	GR3	GR4	GR5	GR6	GR7	GR8	GR9	GR10	LEA
\$2151	\$2302	\$2394	\$2490	\$2589	\$2693	\$2800	\$2912	\$3029	\$3150	\$3275	\$3872

8320P/L Laminate

Laminate
\$2814

8320P/A Acrylic

Acrylic
CALL

OPTIONS

Add upcharge to list price and code to model number

FR	CAL 133 (TB 133) Fire Retardant per yard	\$90/yd.
----	--	----------

DIMENSIONS	Straight Backless	Bariatric Backless
Seat Depth:	27"	27"
Seat Height:	18"	18"
Overall Depth:	27"	27"
Overall Width:	22", 44"	30"
Overall Height:	18"	18"
Qty./Wt.:	1 ea./40/60 lbs.	1 ea./80 lbs.



SINGLE SEAT BACKLESS WITH
OPTIONAL TWO FABRIC

MODEL / DESCRIPTION / LIST PRICING

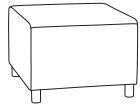

8326 Single Seat Backless Unit 22"

COM Yardage: Total: 2.5 Yds. / Sides: 1.5 Yds. / Top: 1 Yds.

COM	GR1	GR2	GR3	GR4	GR5	GR6	GR7	GR8	GR9	GR10	LEA
\$967	\$1050	\$1131	\$1226	\$1308	\$1403	\$1498	\$1591	\$1686	\$1780	\$1875	\$2010

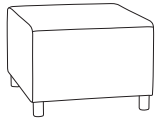

8328 Bariatric Backless Unit 30"

COM Yardage: Total: 3 Yds. / Sides: 2 Yds. / Top: 1 Yds.

COM	GR1	GR2	GR3	GR4	GR5	GR6	GR7	GR8	GR9	GR10	LEA
\$1207	\$1348	\$1490	\$1632	\$1773	\$1914	\$2056	\$2197	\$2339	\$2480	\$2621	\$2758



8330 Two Seat Backless Unit 44"

COM Yardage: Total: 4 Yds. / Sides: 2.5 Yds. / Top: 1.5 Yds.

COM	GR1	GR2	GR3	GR4	GR5	GR6	GR7	GR8	GR9	GR10	LEA
\$1746	\$1887	\$2028	\$2170	\$2312	\$2454	\$2594	\$2736	\$2878	\$3019	\$3161	\$3296

OPTIONS

Add upcharge to list price and code to model number

FR	CAL 133 (TB 133) Fire Retardant per yard	\$90/yd.
MB	Moisture Barrier - up to 60" width	\$125 ea.
WOD	Wood Legs	\$24 ea.
PC	Polished Chrome Legs	\$25 ea.
CAS3	3" Casters	\$25 ea.
2FO	Two Fabric Option	\$98

GD	Ganging Device for Metal/Wood Legs	\$52
TABF-(L)	Fixed Tablet (outside, specify (L/R), shape A, B or C)	\$370
TABFB-(L)	Fixed Tablet (blade, specify (L/R), shape A, B or C)	\$370
LAM5	Non-standard laminate (5 tablets or less)	\$250 ea. tablet
SST	Solid Surface Tablet Arm - add to tablet option	\$125
SS5	Non-standard Solid Surface (5 tablets or less)	Call For Quote

DIMENSIONS	20° Curve Backless	30° Curve Backless	45° Curve Backless	60° Curve Backless
Seat Depth:	27"	27"	27"	27"
Seat Height:	18"	18"	18"	18"
Overall Depth:	28"	29"	30.5"	32.5"
Overall Width:	32"	35"	52"	67"
Overall Height:	18"	18"	18"	18"
Qty./Wt.:	1 ea./42 lbs.	1 ea./62 lbs.	1 ea./82 lbs.	1 ea./102 lbs.



60° CURVE BACKLESS UNIT

MODEL / DESCRIPTION / LIST PRICING

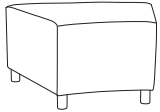

8332 20° Curve Unit (4 legs)

COM Yardage: Total: 2.75 Yds. / Sides: 1.75 Yds. / Top: 1 Yds.

COM	GR1	GR2	GR3	GR4	GR5	GR6	GR7	GR8	GR9	GR10	LEA
\$1083	\$1166	\$1248	\$1343	\$1426	\$1519	\$1614	\$1708	\$1803	\$1897	\$1991	\$2127

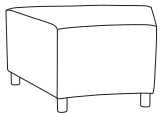

8334 30° Curve Unit (4 legs)

COM Yardage: Total: 3.5 Yds. / Sides: 2 Yds. / Top: 1.5 Yds.

COM	GR1	GR2	GR3	GR4	GR5	GR6	GR7	GR8	GR9	GR10	LEA
\$1163	\$1246	\$1329	\$1422	\$1505	\$1600	\$1694	\$1789	\$1882	\$1977	\$2071	\$2207

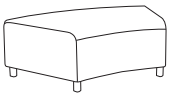

8336 45° Curve Unit (4 legs)

COM Yardage: Total: 5 Yds. / Sides: 3.25 Yds. / Top: 1.75 Yds.

COM	GR1	GR2	GR3	GR4	GR5	GR6	GR7	GR8	GR9	GR10	LEA
\$1618	\$1700	\$1782	\$1877	\$1959	\$2054	\$2147	\$2242	\$2337	\$2431	\$2526	\$2661

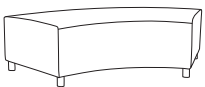

8338 60° Curve Unit (5 legs)

COM Yardage: Total: 5.5 Yds. / Sides: 3 Yds. / Top: 2.5 Yds.

COM	GR1	GR2	GR3	GR4	GR5	GR6	GR7	GR8	GR9	GR10	LEA
\$1977	\$2059	\$2142	\$2237	\$2318	\$2413	\$2507	\$2602	\$2696	\$2790	\$2884	\$3020

OPTIONS

Add upcharge to list price and code to model number

FR	CAL 133 (TB 133) Fire Retardant per yard	\$90/yd.
MB	Moisture Barrier - up to 60" width	\$125 ea.
MB60	Moisture Barrier - over 60" width	\$200 ea.
WOD	Wood Legs	\$24 ea.
PC	Polished Chrome Legs	\$25 ea.
CAS3	3" Casters	\$25 ea.
2FO	Two Fabric Option	\$98

GD	Ganging Device for Metal/Wood Legs	\$52
TABF(-)	Fixed Tablet (outside, specify (L/R), shape A, B or C)	\$370
TABFB(-)	Fixed Tablet (blade, specify (L/R), shape A, B or C)	\$370
LAM5	Non-standard laminate (5 tablets or less)	\$250 ea. tablet
SST	Solid Surface Tablet Arm - add to tablet option	\$125
SS5	Non-standard Solid Surface (5 tablets or less)	Call For Quote

DIMENSIONS	R-L Arm	Center Arm
Overall Depth:	27"	19"
Overall Width:	3"	2"
Overall Height:	25"	21"
Qty./Wt.:	1 ea./25 lbs.	1 ea./10 lbs.



SINGLE SEAT WITH ARMS

MODEL / DESCRIPTION / LIST PRICING

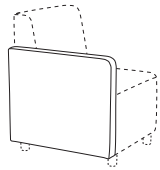

8358L/R Left or Right Arm

COM Yardage: 1.5 Yds..

COM	GR1	GR2	GR3	GR4	GR5	GR6	GR7	GR8	GR9	GR10	LEA
\$245	\$292	\$328	\$375	\$410	\$446	\$481	\$517	\$564	\$610	\$657	\$764

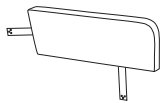

8358C Center Arm (ARM CAP NOT AVAILABLE)

COM Yardage: .75 Yds..

COM	GR1	GR2	GR3	GR4	GR5	GR6	GR7	GR8	GR9	GR10	LEA
\$238	\$286	\$320	\$367	\$403	\$438	\$474	\$509	\$556	\$604	\$651	\$756

Note: Tablet options available on full left or right arm only and cannot be used with arm caps.

OPTIONS

Add upcharge to list price and code to model number

FR	CAL 133 (TB 133) Fire Retardant per yard	\$90/yd.
TAB(-)	Swivel Tablet (specify A, B or C, left or right arm)	\$395
TABR1(-)	Removable Tablet (specify A, B or C, left or right arm)	\$470
TABR2(-)	Removable Tablet (specify A, B or C both arm openings)	\$570
LAM5	Non-standard laminate (5 tablets or less)	\$250 ea. tablet

SST	Solid Surface Tablet Arm - add to tablet option	\$125
SS5	Non-standard Solid Surface (5 tablets or less)	Call For Quote
WAC	Single Wood Arm Cap	\$89
PAC	Poly Arm Cap - Standard Black/Charcoal	\$69 ea.



"S" CONFIGURATION: SIX 60° CURVE UNITS, TWO 60° BACKLESS CURVE UNITS WITH CABANA OCCASIONAL TABLES

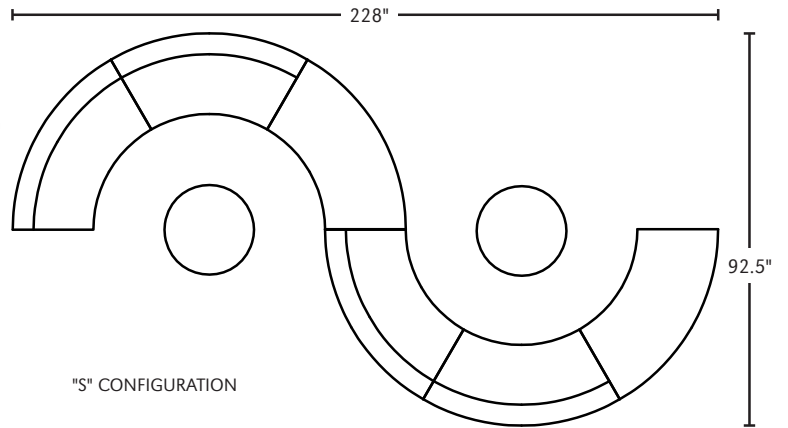

"S" CONFIGURATION



THREE 60° CURVE UNITS, TWO OUTSIDE ARMS, TWO LOUNGE UNITS AND 36" ROUND CABANA TABLE WITH COVE POWER OPTION

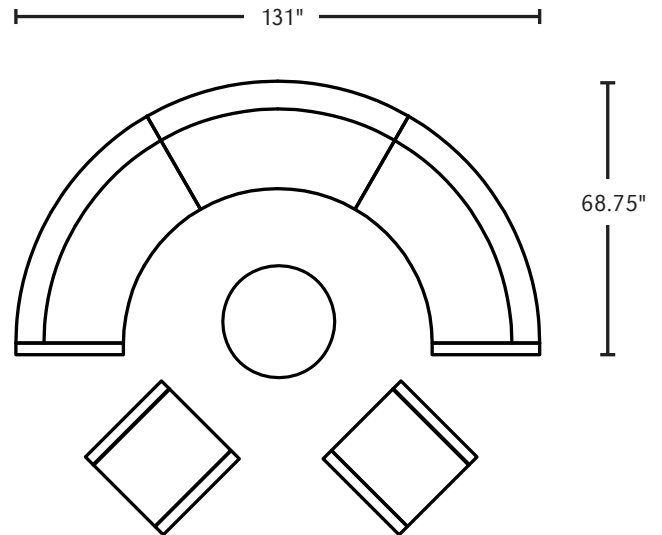

ARC CONFIGURATION



SERPENTINE CONFIGURATION

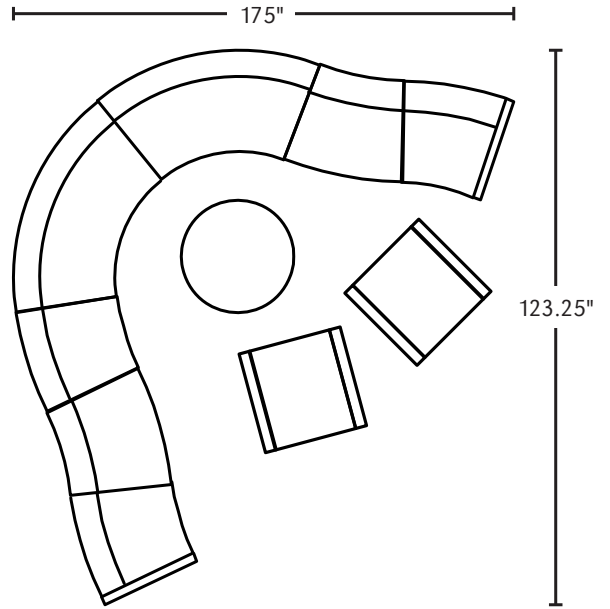

"L" SHAPE CONFIGURATION

ONE CORNER UNIT, SIX STRAIGHT UNITS,, TWO OUTSIDE ARMS, TWO LOUNGE UNITS AND TWO CABANA OCCASIONAL TABLES FEATURING COVE POWER OPTION

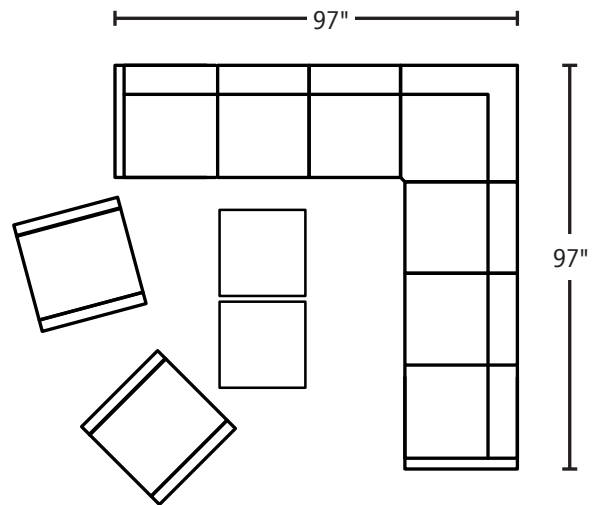

DIMENSIONS	18" Round	24" Round	30" Round	36" Round	42" Round
Overall Depth:	18"	24"	30"	36"	42"
Overall Width:	18"	24"	30"	36"	42"
Overall Height:	18"	18"	18"	18"	18"
Qty./Wt.:	1 ea./26 lbs.	1 ea./37 lbs.	1 ea./48 lbs.	1 ea./68 lbs.	1 ea./84 lbs.



36" ROUND OTTOMAN

MODEL / DESCRIPTION / LIST PRICING



8341 18" Round Ottoman - 4 legs



COM Yardage: Total: 2.75 Yds. / Sides: 2 Yds. / Top: .75 Yds.

COM	GR1	GR2	GR3	GR4	GR5	GR6	GR7	GR8	GR9	GR10	LEA
\$978	\$1118	\$1260	\$1402	\$1543	\$1684	\$1826	\$1967	\$2109	\$2251	\$2391	\$2528

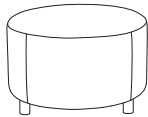

8339 24" Round Ottoman - 4 legs



COM Yardage: Total: 2.25 Yds. / Sides: 1.5 Yds. / Top: .75 Yds.

COM	GR1	GR2	GR3	GR4	GR5	GR6	GR7	GR8	GR9	GR10	LEA
\$1141	\$1283	\$1424	\$1565	\$1707	\$1849	\$1990	\$2131	\$2273	\$2414	\$2556	\$2691

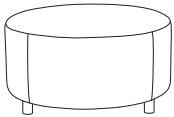

8340 30" Round Ottoman - 4 legs



COM Yardage: Total: 2.5 Yds. / Sides: 1.5 Yds. / Top: 1 Yds.

COM	GR1	GR2	GR3	GR4	GR5	GR6	GR7	GR8	GR9	GR10	LEA
\$1569	\$1710	\$1852	\$1994	\$2135	\$2276	\$2418	\$2559	\$2701	\$2842	\$2983	\$3120

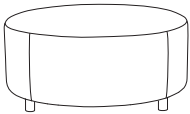

8342 36" Round Ottoman - 4 legs



COM Yardage: Total: 3.75 Yds. / Sides: 2.5 Yds. / Top: 1.25 Yds.

COM	GR1	GR2	GR3	GR4	GR5	GR6	GR7	GR8	GR9	GR10	LEA
\$1887	\$2028	\$2170	\$2312	\$2454	\$2594	\$2736	\$2878	\$3019	\$3161	\$3302	\$3438

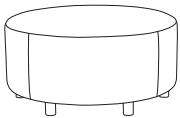

8344 42" Round Ottoman - 6 legs



COM Yardage: Total: 4 Yds. / Sides: 2.5 Yds. / Top: 1.5 Yds.

COM	GR1	GR2	GR3	GR4	GR5	GR6	GR7	GR8	GR9	GR10	LEA
\$2039	\$2181	\$2323	\$2463	\$2605	\$2747	\$2889	\$3029	\$3171	\$3313	\$3454	\$3589

OPTIONS

Add upcharge to list price and code to model number

FR	CAL 133 (TB 133) Fire Retardant per yard	\$90/yd.
MB	Moisture Barrier - per ottoman	\$125
WOD	Wood Legs	\$24 ea.

PC	Polished Chrome Legs	\$25 ea.
CAS3	3" Casters	\$25 ea.
2FO	Two Fabric Option	\$98

DIMENSIONS	18" Round	24" Round	30" Round	36" Round	42" Round
Overall Depth:	18"	24"	30"	36"	42"
Overall Width:	18"	24"	30"	36"	42"
Overall Height:	18"	18"	18"	18"	18"
Qty./Wt.:	1 ea./26 lbs.	1 ea./37 lbs.	1 ea./48 lbs.	1 ea./68 lbs.	1 ea./84 lbs.



ROUND OTTOMAN / NO LEGS
W/ PLASTIC GLIDES

MODEL / DESCRIPTION / LIST PRICING

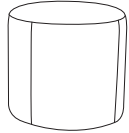

8341-NL 18" Round Ottoman / No Legs



COM Yardage: Total: 2.75 Yds. / Sides: 2 Yds. / Top: .75 Yds.

COM	GR1	GR2	GR3	GR4	GR5	GR6	GR7	GR8	GR9	GR10	LEA
\$913	\$1039	\$1162	\$1287	\$1413	\$1536	\$1661	\$1784	\$1910	\$2035	\$2158	\$2277

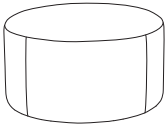

8339-NL 24" Round Ottoman / No Legs



COM Yardage: Total: 2.25 Yds. / Sides: 1.5 Yds. / Top: .75 Yds.

COM	GR1	GR2	GR3	GR4	GR5	GR6	GR7	GR8	GR9	GR10	LEA
\$1058	\$1183	\$1307	\$1431	\$1557	\$1681	\$1805	\$1929	\$2054	\$2179	\$2303	\$2422

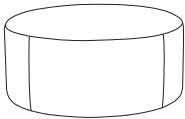

8340-NL 30" Round Ottoman / No Legs

COM Yardage: Total: 2.5 Yds. / Sides: 1.5 Yds. / Top: 1 Yds.

COM	GR1	GR2	GR3	GR4	GR5	GR6	GR7	GR8	GR9	GR10	LEA
\$1433	\$1559	\$1682	\$1807	\$1933	\$2056	\$2181	\$2304	\$2430	\$2555	\$2678	\$2797

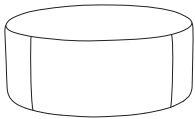

8342-NL 36" Round Ottoman / No Legs

COM Yardage: Total: 3.75 Yds. / Sides: 2.5 Yds. / Top: 1.25 Yds.

COM	GR1	GR2	GR3	GR4	GR5	GR6	GR7	GR8	GR9	GR10	LEA
\$1704	\$1828	\$1952	\$2078	\$2201	\$2326	\$2450	\$2575	\$2700	\$2823	\$2948	\$3067

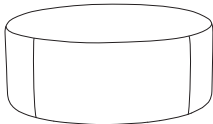

8344-NL 42" Round Ottoman / No Legs

COM Yardage: Total: 4 Yds. / Sides: 2.5 Yds. / Top: 1.5 Yds.

COM	GR1	GR2	GR3	GR4	GR5	GR6	GR7	GR8	GR9	GR10	LEA
\$1849	\$1973	\$2097	\$2223	\$2347	\$2471	\$2595	\$2720	\$2845	\$2969	\$3093	\$3212

OPTIONS

Add upcharge to list price and code to model number

FR	CAL 133 (TB 133) Fire Retardant per yard	\$90/yd.
MB	Moisture Barrier - per ottoman	\$125

2FO	Two Fabric Option	\$98
-----	-------------------	------

DIMENSIONS	27" Square	36" Square	42" Square
Overall Depth:	27"	36"	42"
Overall Width:	27"	36"	42"
Overall Height:	18"	18"	18"
Qty./Wt.:	1 ea./50 lbs.	1 ea./58 lbs.	1 ea./78 lbs.



27" SQUARE WITH CASTERS
AND FIXED TABLET ARMS



36" SQUARE OTTOMAN

MODEL / DESCRIPTION / LIST PRICING

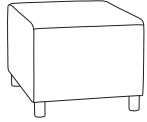

8346 27" Square Ottoman



COM Yardage: Total: 3 Yds. / Sides: 2 Yds. / Top: 1 Yds.

COM	GR1	GR2	GR3	GR4	GR5	GR6	GR7	GR8	GR9	GR10	LEA
\$1143	\$1285	\$1427	\$1567	\$1709	\$1851	\$1993	\$2134	\$2275	\$2417	\$2558	\$2693

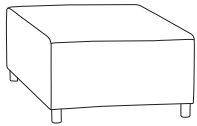

8348 36" Square Ottoman

COM Yardage: Total: 3.75 Yds. / Sides: 2.5 Yds. / Top: 1.25 Yds.

COM	GR1	GR2	GR3	GR4	GR5	GR6	GR7	GR8	GR9	GR10	LEA
\$1748	\$1890	\$2031	\$2172	\$2314	\$2456	\$2597	\$2738	\$2880	\$3021	\$3163	\$3298

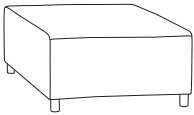

8350 42" Square Ottoman

COM Yardage: Total: 4Yds. / Sides: 2.5 Yds. / Top: 1.5 Yds.

COM	GR1	GR2	GR3	GR4	GR5	GR6	GR7	GR8	GR9	GR10	LEA
\$2042	\$2183	\$2325	\$2466	\$2607	\$2749	\$2891	\$3032	\$3173	\$3315	\$3456	\$3592

OPTIONS

Add upcharge to list price and code to model number

FR	CAL 133 (TB 133) Fire Retardant per yard	\$90/yd.
MB	Moisture Barrier - per ottoman	\$125
WOD	Wood Legs	\$24 ea.
PC	Polished Chrome Legs	\$25 ea.
CAS3	3" Casters	\$25 ea.
2FO	Two Fabric Option	\$98

GD	Ganging Device for Metal/Wood Legs	\$52
TABF-()	Fixed Tablet (outside, specify (L/R), shape A, B or C)	\$370
TABFB-()	Fixed Tablet (blade, specify (L/R), shape A, B or C)	\$370
LAM5	Non-standard laminate (5 tablets or less)	\$250 ea. tablet
SST	Solid Surface Tablet Arm - add to tablet option	\$125
SS5	Non-standard Solid Surface (5 tablets or less)	Call For Quote

DIMENSIONS	Straight Benches
Overall Depth:	20"
Overall Width:	22, 44, 66"
Overall Height:	18"
Qty./Wt.:	1 ea./45/60/78 lbs.



THREE SEAT STRAIGHT BENCH

MODEL / DESCRIPTION / LIST PRICING

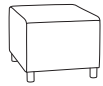

8352 Single Seat Straight Bench

COM Yardage: Total: 2.25 Yds. / Sides: 1.5 Yds. / Top: .75 Yds.

COM	GR1	GR2	GR3	GR4	GR5	GR6	GR7	GR8	GR9	GR10	LEA
\$957	\$1040	\$1123	\$1216	\$1299	\$1393	\$1488	\$1582	\$1676	\$1770	\$1865	\$2000



8354 Two Seat Straight Bench

COM Yardage: Total: 3.25 Yds. / Sides: 1.75 Yds. / Top: 1.5 Yds.

COM	GR1	GR2	GR3	GR4	GR5	GR6	GR7	GR8	GR9	GR10	LEA
\$1678	\$1819	\$1961	\$2102	\$2243	\$2385	\$2527	\$2667	\$2809	\$2951	\$3092	\$3227



8356 Three Seat Straight Bench

COM Yardage: Total: 4.5 Yds. / Sides: 2.5 Yds. / Top: 2 Yds.

COM	GR1	GR2	GR3	GR4	GR5	GR6	GR7	GR8	GR9	GR10	LEA
\$1972	\$2114	\$2255	\$2397	\$2538	\$2679	\$2821	\$2963	\$3104	\$3245	\$3387	\$3523

OPTIONS

Add upcharge to list price and code to model number

FR	CAL 133 (TB 133) Fire Retardant per yard	\$90/yd.	GD	Ganging Device for Metal/Wood Legs	\$52
MB	Moisture Barrier - up to 60" width	\$125 ea.	TABF(-)	Fixed Tablet (outside, specify (L/R), shape A, B or C)	\$370
MB60	Moisture Barrier - over 60" width	\$200 ea.	TABFB(-)	Fixed Tablet (blade, specify (L/R), shape A, B or C)	\$370
WOD	Wood Legs	\$24 ea.	LAM5	Non-standard laminate (5 tablets or less)	\$250 ea. tablet
PC	Polished Chrome Legs	\$25 ea.	SST	Solid Surface Tablet Arm - add to tablet option	\$125
CAS3	3" Casters	\$25 ea.	SS5	Non-standard Solid Surface (5 tablets or less)	Call For Quote
2FO	Two Fabric Option	\$98			

OPTIONS

- CODE: FR - CAL 133 (TB 133) Fire Retardant
- CODE: MB - Moisture Barrier
- CODE: LOW - Fully Upholstered Low Back - 27" OA Height
- CODE: WOD - Wood Legs
- CODE: PC - Polished Chrome Legs
- CODE: CAS3 - 3" Casters
- CODE: 2FO - Two Fabric Option
- CODE: WAC - Wood Arm Caps
- CODE: PAC - Poly Arm Caps - Standard Black/Charcoal
- CODE: 3FO - Three Fabric Option
- CODE: GD - Ganging Device (Necessary when ganging two or more modules together)

- CODE: TAB(-) - Non-Removable Swivel Tablet (laminated shape A, B or C left or right arm)
- CODE: TABR1(-) - Removable Swivel Tablet (laminated shape A, B or C specify left or right arm)
- CODE: TABR2(-) - Removable Swivel Tablet (laminated shape A, B or C with opening for tablet on both arms)
- CODE: LAM5 - Non-standard laminate for 5 or less tablets see options for upcharge
- CODE: SST - Solid Surface Tablet Arm - add to tablet option.
- CODE: SS5 - Non-standard Solid Surface top for 5 or less tablets
- CODE: CO - Clean Out (overall width up to 50")
- CODE: CO1 - Clean Out (overall width over 50")

Note:

- Tablet orders of 5 or less - choice of 3 standard laminate colors: Wilsonart Black 1595-60, Formica Brite White 459-58 or Nevamar Silver Alu Metalx MXT003.
- Tablet orders of 6 or more - any choice standard laminate colors.

Note: Factory installed power/data available, see accessories online under the 'Products' tab.



RAVEN LOUNGE



RAVEN TWO SEAT LOUNGE

TABLET SHAPES

Choose from 3 Tablet Shapes:

Tablets for all modular series are available in 3 shapes, choose from the three shapes shown and specify; A, B or C and left or right (outside tablet) when ordering. Example: TAB-(A) Left - this would be a swivel shape A tablet on the left side (when seated).

Optional Solid Surface available.

Note: Tablets can not be used with Arm Caps.

Tablet orders of 5 or less:

3 standard laminate colors:

Wilsonart Black 1595-60, Formica Brite White 459-58 or Nevamar Silver Alu Metalx MXT003.

4 standard Corian colors:

Bone, Bronzite, Glacier White, and Silver Grey.

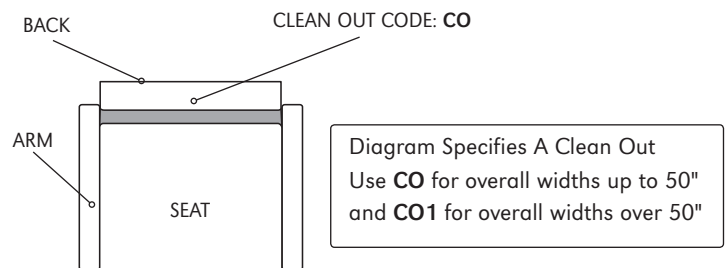
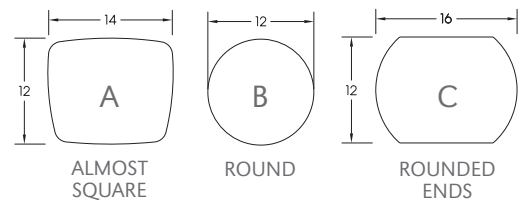

LOW-BACK



CASTERS

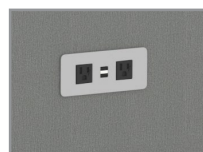

ELECTRICAL/DATA

DIMENSIONS	Single Seat Lounge	Two Seat Lounge
Seat Depth:	20"	20"
Seat Height:	18"	18"
Arm Height:	25"	25"
Overall Depth:	27"	27"
Overall Width:	27"	49"
Overall Height:	33"	33"
Qty./Wt.:	1 ea./65 lbs.	1 ea./105 lbs.



RAVEN SINGLE LOUNGE
WITH OPTIONAL LOW BACK

MODEL / DESCRIPTION / LIST PRICING



8403 Single Seat Lounge



COM Yardage: Total: 7 Yds. / Back: 2 Yds. / Seat: 2 Yds./ Arms(2) 3 Yds.

COM	GR1	GR2	GR3	GR4	GR5	GR6	GR7	GR8	GR9	GR10	LEA
\$1678	\$1855	\$2008	\$2196	\$2350	\$2515	\$2680	\$2845	\$3033	\$3222	\$3411	\$3757

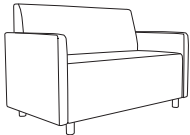

8401 Two Seat Lounge

COM Yardage: Total: 10 Yds. / Back: 4 Yds. / Seat: 3 Yds. / Arms(2) 3 Yds.

COM	GR1	GR2	GR3	GR4	GR5	GR6	GR7	GR8	GR9	GR10	LEA
\$2450	\$2687	\$2898	\$3135	\$3346	\$3559	\$3771	\$3983	\$4219	\$4455	\$4690	\$5039

OPTIONS

Add upcharge to list price and code to model number

FR	CAL 133 (TB 133) Fire Retardant per yard	\$90/yd.
MB	Moisture Barrier - per seat	\$125
LOW	Fully Upholstered Low Back - 27" OA Height	\$95
WOD	Wood Legs	\$24 ea.
PC	Polished Chrome Legs	\$25 ea.
PB	Laminate Plinth Base - Straight Unit	\$160
CAS3	3" Casters	\$25 ea.
2FO	Two Fabric Option	\$98
3FO	Three Fabric Option	\$148
GD	Ganging Device	\$52

TAB(-)	Swivel Tablet (specify A, B or C, left or right arm)	\$395
TABR1(-)	Removable Tablet (specify A, B or C, left or right arm)	\$470
TABR2(-)	Removable Tablet (specify A, B or C both arm openings)	\$570
LAM5	Non-standard laminate (5 tablets or less)	\$250 ea. tablet
SST	Solid Surface Tablet Arm - add to tablet option	\$125
SS5	Non-standard Solid Surface (5 tablets or less)	Call For Quote
WAC	Wood Arm Cap	\$89 ea.
PAC	Poly Arm Cap - Standard Black/Charcoal	\$69 ea.
CO	Clean Out (overall width up to 50")	\$250
CO1	Clean Out (overall width over 50")	\$385

RAVEN OCCASIONAL TABLE & CURIO

The Raven curio and occasional tables feature open construction, perfect for common areas or waiting rooms. The curio offers two sizes to fit inline with standard or low back modular units. The occasional tables have open fronts with closed or open back offering great flexibility. Fully laminated construction is supported by 2" diameter steel tube legs in your choice of powder coat colors or optional wood or polished chrome.



STANDARD BACK - 33" HEIGHT

RAVEN MODULAR LOUNGE AND STANDARD BACK CURIOS WITH OPEN OCCASIONAL TABLE

ORDERING INFORMATION

- | | |
|--------------------------|--------------------------|
| 1) Series Name | 5) Laminate Selection |
| 2) Model Number | 6) Optional 2nd Laminate |
| 3) Quantity | 7) Optional Items |
| 4) Powder Coat Leg Color | |

OPTIONS

- CODE: 2LC - Two Color Laminate Choices
- CODE: PC - Polished Chrome Legs
- CODE: WOD - Wood Legs.

RAVEN SPECIFICATIONS

Table

Table core is CARB Phase I & Phase II Compliant. Laminate and phenolic backing are glued with water based adhesives.

Table Tops

ERG offers over 1000 standard laminate choices from Nevamar, Wilsonart, Formica and Pionite. Solid Surface, 3Form Chroma and stone table tops will be quoted upon request.

Metal Legs

Legs are of 2" diameter 3" tall, round steel tubing. Legs are sandblasted prior to final powder coating in your choice of standard powder coat colors. Legs have a factory installed poly vinyl glide.



STANDARD BACK CURIO / POWER-DATA



LOW BACK CURIO



STANDARD BACK CURIO / POWER-DATA

MODEL / DESCRIPTION / LIST PRICING

RAVEN CURIO | LOW BACK

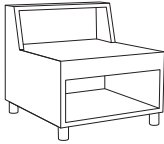

Model Number	Model Description	Curio Size	Overall Height	Shpg. Weight	LAMINATE
RAVCUR27	Occasional	24" x 26"	27"	95 lbs.	\$3257

RAVEN CURIO | STANDARD BACK



Model Number	Model Description	Curio Size	Overall Height	Shpg. Weight	LAMINATE
RAVCUR33	Occasional	24" x 26"	33"	140 lbs.	\$3704

OPTIONS

Add upcharge to list price and code to model number

2LC	Two Color Laminate Choices	\$175	WOD	Wood Legs	\$24 ea.
PC	Polished Chrome Legs	\$25 ea.			



ANGLED / OPEN FRONT & BACK



STRAIGHT FRONT / CLOSED BACK

MODEL / DESCRIPTION / LIST PRICING

RAVEN OCCASIONAL TABLES | ANGLED BOTH ENDS / OPEN FRONT & BACK

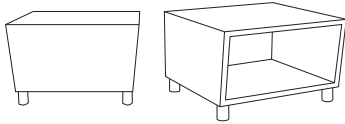

Model Number	Model Description	Table Top Size	Table Height	Table Shape	Shpg. Weight	LAMINATE
--------------	-------------------	----------------	--------------	-------------	--------------	----------

ORAVABO	Occasional	24" x 26"	17"	Rectangular	40 lbs.	\$1929
---------	------------	-----------	-----	-------------	---------	--------

RAVEN OCCASIONAL TABLES | FRONT ANGLED / CLOSED BACK

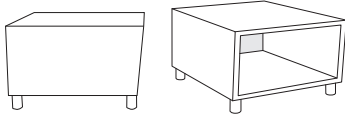

Model Number	Model Description	Table Top Size	Table Height	Table Shape	Shpg. Weight	LAMINATE
--------------	-------------------	----------------	--------------	-------------	--------------	----------

ORAVFAC	Occasional	24" x 26"	17"	Rectangular	40 lbs.	\$1940
---------	------------	-----------	-----	-------------	---------	--------

RAVEN OCCASIONAL TABLES | STRAIGHT BOTH ENDS / OPEN FRONT & BACK

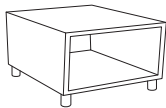

Model Number	Model Description	Table Top Size	Table Height	Table Shape	Shpg. Weight	LAMINATE
--------------	-------------------	----------------	--------------	-------------	--------------	----------

ORAVSBOB	Occasional	24" x 26"	17"	Rectangular	40 lbs.	\$1865
----------	------------	-----------	-----	-------------	---------	--------

RAVEN OCCASIONAL TABLES | STRAIGHT BOTH ENDS / CLOSED BACK

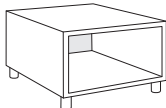

Model Number	Model Description	Table Top Size	Table Height	Table Shape	Shpg. Weight	LAMINATE
--------------	-------------------	----------------	--------------	-------------	--------------	----------

ORAVSBCB	Occasional	24" x 26"	17"	Rectangular	40 lbs.	\$1897
----------	------------	-----------	-----	-------------	---------	--------

OPTIONS

Add upcharge to list price and code to model number

2LC	Two Color Laminate Choices	\$175	WOD	Wood Legs	\$24 ea.
PC	Polished Chrome Legs	\$25 ea.			

RAVEN JUNIOR COLLECTION

The Raven Junior Lounge Series offers great creativity and flexibility in children's seating. Designed for children's areas and any public spaces that require durable seating.



60° CURVE UNIT



RAVEN JUNIOR



RAVEN JUNIOR
MODULAR CONFIGURATION

ORDERING INFORMATION

- | | |
|----------------------------|-------------------------------|
| 1) Series Name | 5) Powder Coat Color for legs |
| 2) Model Number | 6) Optional Items |
| 3) Quantity | |
| 4) Fabric Grade and Number | |

RAVEN MODULAR LOUNGE SPECIFICATIONS

Frame Construction

Frame assembly is constructed of multi-ply hardwood, with tongue and groove construction. All foam is fully bonded to frame. Seat cushions are 4" graded high resiliency (H.R.) block foam with back 3" (H.R.) foam, covered entirely with special bonded polyester fiber to protect final upholstery. No sag-springs are installed in seat & back along with interlocking helicoil springs to prevent sagging and provide additional lower back and seat support.

Upholstery

Seat and back are covered in choice of fabric, vinyl, crypton, leather or COM. ERG uses only water based glues and adhesives in our upholstery process.

Legs

2"RD X 3"H round tubular steel legs are standard and available in standard powder coat colors. Optional polished chrome and wood legs are also available. Legs have a factory installed poly vinyl glide.

COLORS / FINISHES

Legs

Standard powder coat colors or optional polished chrome available. Wood legs are finished in your choice of standard wood stain colors.

OPTIONS

- CODE: FR - CAL 133 (TB 133) Fire Retardant.
- CODE: MB - Moisture Barrier (Up To 60" Overall Width).
- CODE: WOD - Wood Legs.
- CODE: PC - Polished Chrome Legs.
- CODE: CAS3 - 3" Black Casters.
- CODE: 2FO - Two Fabric Option.
- CODE: GD - Ganging Device (Necessary when ganging two or more modules together).

DIMENSIONS	Single Unit	Two Seat Unit	Two Seat Backless Unit	Ottoman
Seat Depth:	17.5"	17.5"	24"	24"
Seat Height:	16"	16"	16"	16"
Overall Depth:	24"	24"	24"	24"
Overall Width:	18"	42"	42"	24"
Overall Height:	27.5"	27.5"	16"	16"
Qty./Wt.:	1 ea./35 lbs.	1 ea./60 lbs.	1 ea./55 lbs.	1 ea./40 lbs.



SINGLE UNIT

MODEL / DESCRIPTION / LIST PRICING



8400 Single Unit (4 Legs)

COM Yardage: Total: 3 Yds. / Back: 1.5 Yds. / Seat: 1.5 Yds.

COM	GR1	GR2	GR3	GR4	GR5	GR6	GR7	GR8	GR9	GR10	LEA
\$974	\$1043	\$1085	\$1128	\$1173	\$1221	\$1270	\$1320	\$1372	\$1428	\$1485	\$1755

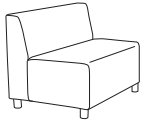

8402 Two Seat Unit (4 Legs)

COM Yardage: Total: 4.5 Yds. / Back: 2.5 Yds. / Seat: 2 Yds.

COM	GR1	GR2	GR3	GR4	GR5	GR6	GR7	GR8	GR9	GR10	LEA
\$1551	\$1659	\$1725	\$1795	\$1867	\$1941	\$2020	\$2100	\$2184	\$2272	\$2362	\$2793



8404 Two Seat Backless Unit (4 Legs)

COM Yardage: Total: 3.5 Yds. / Top: 1.5 Yds. / Sides: 2 Yds.

COM	GR1	GR2	GR3	GR4	GR5	GR6	GR7	GR8	GR9	GR10	LEA
\$1240	\$1327	\$1381	\$1434	\$1492	\$1552	\$1615	\$1679	\$1746	\$1817	\$1888	\$2233

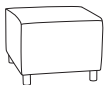

8406 Ottoman (4 Legs)

COM Yardage: Total: 2.75 Yds. / Top: .75 Yds. / Sides: 1.5 Yds.

COM	GR1	GR2	GR3	GR4	GR5	GR6	GR7	GR8	GR9	GR10	LEA
\$791	\$847	\$881	\$916	\$952	\$990	\$1031	\$1070	\$1114	\$1159	\$1204	\$1424



RAVEN JUNIOR CONFIGURATION

OPTIONS

Add upcharge to list price and code to model number

FR	CAL 133 (TB 133) Fire Retardant per yard	\$90/yd.
MB	Moisture Barrier - up to 60" overall width	\$125
2FO	Two Fabric Option	\$98
GD	Ganging Device	\$52

PC	Polished Chrome Legs	\$25 ea.
CAS3	3" Black Casters	\$25 ea.
WOD	Solid Wood Legs	\$24 ea.

DIMENSIONS	30° curve unit (inside / outside)	60° curve unit (inside / outside)	Backless 30° unit	Backless 60° unit
Seat Depth:	17.5"	17.5"	24"	24"
Seat Height:	16"	16"	16"	16"
Overall Depth:	26"	28"	26"	28"
Overall Width:	24.5"	47"	34.5"	47"
Overall Height:	27.5"	27.5"	16"	16"
Qty./Wt.:	1 ea./62 lbs.	1 ea./110 lbs.	1 ea./35 lbs.	1 ea./55 lbs.



60° CURVE UNIT

MODEL / DESCRIPTION / LIST PRICING



8408 30° inside curve unit (4 Legs)

COM Yardage: Total: 4 Yds. / Back: 2 Yds. / Seat: 2 Yds.

COM	GR1	GR2	GR3	GR4	GR5	GR6	GR7	GR8	GR9	GR10	LEA
\$993	\$1062	\$1105	\$1149	\$1195	\$1243	\$1293	\$1344	\$1397	\$1454	\$1511	\$1788



8410 30° outside curve unit (4 Legs)

COM Yardage: Total: 4.5 Yds. / Back: 2 Yds. / Seat: 2.5 Yds.

COM	GR1	GR2	GR3	GR4	GR5	GR6	GR7	GR8	GR9	GR10	LEA
\$993	\$1062	\$1105	\$1149	\$1195	\$1243	\$1293	\$1344	\$1397	\$1454	\$1511	\$1788

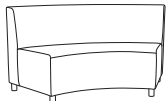

8412 60° inside curve unit (5 Legs)

COM Yardage: Total: 6.5 Yds. / Back: 4 Yds. / Seat: 2.5 Yds.

COM	GR1	GR2	GR3	GR4	GR5	GR6	GR7	GR8	GR9	GR10	LEA
\$1674	\$1791	\$1863	\$1937	\$2014	\$2095	\$2179	\$2267	\$2357	\$2450	\$2550	\$3014



8414 60° outside curve unit (5 Legs)

COM Yardage: Total: 7 Yds. / Back: 3 Yds. / Seat: 4 Yds.

COM	GR1	GR2	GR3	GR4	GR5	GR6	GR7	GR8	GR9	GR10	LEA
\$1674	\$1791	\$1863	\$1937	\$2014	\$2095	\$2179	\$2267	\$2357	\$2450	\$2550	\$3014

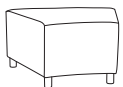

8416 Backless 30° unit (4 Legs)

COM Yardage: Total: 3 Yds. / Top: 1 Yds. / Sides: 2 Yds.

COM	GR1	GR2	GR3	GR4	GR5	GR6	GR7	GR8	GR9	GR10	LEA
\$895	\$958	\$996	\$1036	\$1078	\$1121	\$1164	\$1211	\$1260	\$1310	\$1363	\$1610



8418 Backless 60° unit (5 Legs)

COM Yardage: Total: 4.75 Yds. / Top: 2 Yds. / Sides: 2.75 Yds.

COM	GR1	GR2	GR3	GR4	GR5	GR6	GR7	GR8	GR9	GR10	LEA
\$1410	\$1509	\$1570	\$1632	\$1697	\$1765	\$1836	\$1909	\$1985	\$2064	\$2146	\$2539

OPTIONS

Add upcharge to list price and code to model number

FR	CAL 133 (TB 133) Fire Retardant per yard	\$90/yd.
MB	Moisture Barrier - up to 60" overall width	\$125
2FO	Two Fabric Option	\$98
GD	Ganging Device	\$52

PC	Polished Chrome Legs	\$25 ea.
CAS3	3" Black Casters	\$25 ea.
WOD	Solid Wood Legs	\$24 ea.