



VENTURA TABLE OF CONTENTS

Ventura Specifications and Options	2
Ventura Guest Seat Pricing	4
Ventura Multiple Seat Pricing	6
Ventura Bench Specification and Options	8
Ventura Bench Pricing	10
Ventura Occasional Tables Specification and Options	12
Ventura Occasional Table Pricing	13
Ventura Configurations.....	15

VENTURA COLLECTION

Ventura offers stylish upholstered guest seating and is an environmentally preferred product.



VENTURA METAL



VENTURA WOOD

ORDERING INFORMATION

To Order Please Specify:

- 1) Series Name
- 2) Model Number
- 3) Quantity
- 4) Arm Cap Selection / Finish
- 5) Polyurethane Arm Cap
Black or Charcoal
- 6) Fabric Grade & Number
- 7) Optional Items
- 8) Wood Stain Finish Color
- 9) Frame Color / Finish

VENTURA GENERAL SPECIFICATIONS

Metal Frame Construction

1"x2" rectangular steel tubing, fabricated and all welded with built-in wall saver design.

Wood Frame Construction

All hardwood with built-in wall saver design. Tongue & groove hardwood construction.

Back

Webbing installed and high-resiliency foam bonded to wood frame. Concealed back attachment to frame.

Seat

No-sag spring installed. Helicoil springs attached to spring and high resiliency foam is bonded to metal frame.

Underseat

Metal - Steel welded frame, welded to legs and metal apron.
Wood - Steel welded frame with machine screws attached to wood frame.

Upholstery

High resiliency foam is being used. ERG uses only water based glues and adhesives in our upholstery process. Seat is covered in choice of fabric, vinyl, crypton, leather or COM. Adjustable glides installed.

COLORS / FINISHES

Metal Finish Colors:

Standard powder coat colors available.

Wood Stain for optional wood arm caps:

All transparent wood stain colors available.

Wood Frame Arm Caps:

Unit comes standard with poly arm caps

- Black
- Charcoal

**Standard Polyurethane Arm Caps
(Wood Frame Only)**



BLACK POLY ARM CAP – **VWAC2**



CHARCOAL POLY ARM CAP – **VWAC3**

MULTIPLE SEATING

WOOD CHAIRS	WEIGHT LIMIT
Per Seat	350 lbs.
Bariatric	500 lbs.
METAL CHAIRS	WEIGHT LIMIT
Per Seat	500 lbs.
Bariatric	750 lbs.

LOUNGE

SOFT SEATING	WEIGHT LIMIT
1 Seat	500 lbs.
2 Seat	1000 lbs.
3 Seat	1500 lbs.

OPTIONS

METAL FRAME (VM)

- CODE: FR - CAL 133 (TB 133) Fire Retardant
- CODE: MB - Moisture Barrier
- CODE: 2FO/C - Two Fabric Option (per seat)
- CODE: FM - Floor Mount
- CODE: VMAC2 - Arm Caps, Black Polyurethane
- CODE: VMAC3 - Arm Caps, Charcoal Polyurethane
- CODE: VMAC4 - Arm Caps, White Solid Surface (Glacier White by Corian)
- CODE: VMAC5 - Arm Caps, Brown Solid Surface (Bronzite by Corian)
- CODE: VMAC7 - Arm Caps, Beige Solid Surface (Bone by Corian)
- CODE: VMAC8 - Arm Caps, Gray Solid Surface (Silver Grey by Corian)
- CODE: VMAC6 - Arm Caps, Solid Wood

WOOD FRAME (VW)

- CODE: FR - CAL 133 (TB 133) Fire Retardant
- CODE: MB - Moisture Barrier
- CODE: 2FO/C - Two Fabric Option (per seat)
- CODE: FM - Floor Mount
- CODE: VWAC6 - Arm Cap, Wood
- CODE: AG - Adjustable Glides

METAL FRAME



BLACK POLYURETHANE
ARM CAP – **VMAC2**



CHARCOAL POLYURETHANE
ARM CAP – **VMAC3**



WHITE SOLID SURFACE
ARM CAP – **VMAC4**



BROWN SOLID SURFACE
ARM CAP – **VMAC5**



BEIGE SOLID SURFACE
ARM CAP – **VMAC7**

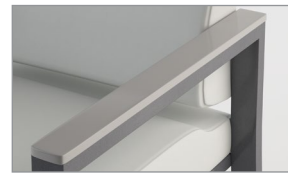

GRAY SOLID SURFACE
ARM CAP – **VMAC8**



WOOD ARM CAP
VMAC6

WOOD FRAME



WOOD ARM CAP
VWAC6



VENTURA METAL BARIATRIC
WITH ARM CAPS

DIMENSIONS	Arm Chair	Patient Back Chair	Bariatric Chair
Seat Width:	21"	21"	30"
Seat Depth:	19"	19"	19"
Seat Height:	18"	18"	18"
Back Height:	35"	45"	35"
Arm Height:	24.5"	24.5"	24.5"
Overall Width:	25"	25"	35"
Overall Depth:	27"	27"	27"
Qty./Wt. per carton:	1 ea./55 lbs.	1 ea./65 lbs.	1 ea./85 lbs.

MODEL / DESCRIPTION / LIST PRICING



3103 Metal - Arm Chair

COM Yardage: 2.25 Yds. Seat 1 Yd / Back 1.25 Yds.

COM	GR1	GR2	GR3	GR4	GR5	GR6	GR7	GR8	GR9	GR10	LEA
\$1356	\$1451	\$1509	\$1569	\$1632	\$1697	\$1765	\$1836	\$1909	\$1985	\$2064	\$2441



3105 Metal - Patient Back Arm Chair

COM Yardage: 2.75 Yds. Seat 1 Yd / Back 1.75 Yds.

COM	GR1	GR2	GR3	GR4	GR5	GR6	GR7	GR8	GR9	GR10	LEA
\$1569	\$1679	\$1746	\$1816	\$1888	\$1964	\$2043	\$2124	\$2209	\$2298	\$2389	\$2824



3104 Metal - Bariatric Arm Chair

COM Yardage: 3 Yds. Seat 1.5 Yd. / Back 1.5 Yds.

COM	GR1	GR2	GR3	GR4	GR5	GR6	GR7	GR8	GR9	GR10	LEA
\$1644	\$1759	\$1829	\$1902	\$1978	\$2058	\$2140	\$2226	\$2314	\$2407	\$2504	\$2958

OPTIONS

Add upcharge to list price and code to model number

FR	CAL 133 (TB 133) Fire Retardant per yard	\$90/yd
MB	Moisture Barrier on seat	\$125
2FO/C	2 Fabric Option	\$49 per seat
VMAC2	Polyurethane Arm Caps - Black	\$48 each
VMAC3	Polyurethane Arm Caps - Charcoal	\$48 each
VMAC4	Solid Surface Arm Caps - White	\$108 each

VMAC5	Solid Surface Arm Caps - Brown	\$108 each
VMAC7	Solid Surface Arm Caps - Beige	\$108 each
VMAC8	Solid Surface Arm Caps - Gray	\$108 each
VMAC6	Solid Wood Arm Caps	\$80 each
FM	Floor Mount	\$98

DIMENSIONS	Arm Chair	Bariatric Chair	Patient Back Chair
Seat Width:	21"	30"	21"
Seat Depth:	19"	19"	19"
Seat Height:	17.5"	17.5"	17.5"
Back Height:	35"	35"	45"
Arm Height:	25"	25"	25"
Overall Width:	26"	35"	26"
Overall Depth:	25"	25"	25"
Qty./Wt. per carton:	1 ea./36 lbs.	1 ea./47 lbs.	1 ea./53 lbs.



VENTURA BARIATRIC
WITH OPTIONAL
WOOD ARM CAPS

MODEL / DESCRIPTION / LIST PRICING



3021 Wood Arm Chair

COM Yardage: 2.25 Yds. Seat 1 Yd. / Back 1.25 Yds.

COM	GR1	GR2	GR3	GR4	GR5	GR6	GR7	GR8	GR9	GR10	LEA
\$1033	\$1105	\$1150	\$1196	\$1244	\$1293	\$1345	\$1398	\$1455	\$1513	\$1574	\$1860



3024 Wood Patient Back Arm Chair

COM Yardage: 2.75 Yds. Seat 1 Yd. / Back 1.75 Yds.

COM	GR1	GR2	GR3	GR4	GR5	GR6	GR7	GR8	GR9	GR10	LEA
\$1188	\$1271	\$1322	\$1374	\$1430	\$1487	\$1547	\$1608	\$1673	\$1740	\$1809	\$2139



3021BAR Wood Bariatric

COM Yardage: 3 Yds. Seat 1.5 Yds. / Back 1.5 Yds.

COM	GR1	GR2	GR3	GR4	GR5	GR6	GR7	GR8	GR9	GR10	LEA
\$1490	\$1595	\$1658	\$1724	\$1794	\$1865	\$1940	\$2018	\$2098	\$2182	\$2269	\$2682

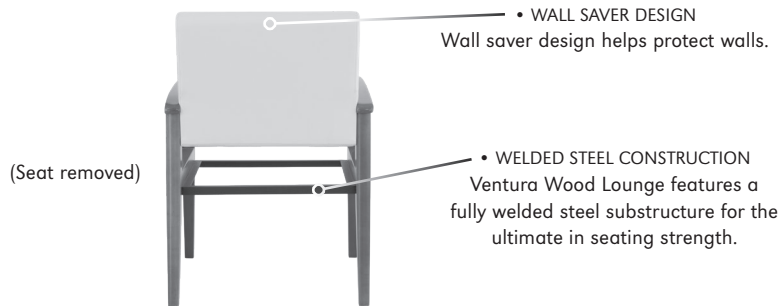

OPTIONS

Add upcharge to list price and code to model number

AG	Adjustable Glide	\$19/pair
FR	CAL 133 (TB 133) Fire Retardant per yard	\$90/yd
MB	Moisture Barrier on seat	\$125
2FO/C	2 Fabric Option	\$49 per seat

VWAC2	Polyurethane Arm Caps - Black	-
VWAC3	Polyurethane Arm Caps - Charcoal	-
VWAC6	Solid Wood Arm Caps	\$80 each



VENTURA METAL TWO-SEAT LOUNGE
WITH DIVIDING ARM AND OPTIONAL ARM CAPS

DIMENSIONS	Two Seat Lounge	Two Seat Center Arm	Three Seat Lounge	Three Seat Center Arms
Seat Width:	42"	21" (2)	63"	21" (3)
Seat Depth:	19"	19"	19"	19"
Seat Height:	18"	18"	18"	18"
Back Height:	35"	35"	35"	35"
Overall Width:	46"	48"	67"	71"
Overall Depth:	27"	27"	27"	27"
Qty./Wt. per carton:	1 ea./100 lbs.	1 ea./110 lbs.	1 ea./150 lbs.	1 ea./150 lbs.

MODEL / DESCRIPTION / LIST PRICING

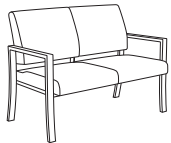

3106 Metal - 2-Seat Lounge

COM Yardage: 4 Yds. Seat 2 Yd. / Back 2 Yds.

COM	GR1	GR2	GR3	GR4	GR5	GR6	GR7	GR8	GR9	GR10	LEA
\$2401	\$2569	\$2672	\$2778	\$2890	\$3005	\$3125	\$3250	\$3380	\$3515	\$3656	\$4322

COM Yardage (Optional two fabrics): Backs: 1.5 Yds / Seats: 1.5 Yds

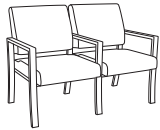

3108 Metal - 2-Seat Lounge w/Dividing Arms

COM Yardage: 4 Yds. Seat 2 Yd. / Back 2 Yds.

COM	GR1	GR2	GR3	GR4	GR5	GR6	GR7	GR8	GR9	GR10	LEA
\$2507	\$2682	\$2789	\$2902	\$3017	\$3138	\$3263	\$3394	\$3529	\$3671	\$3817	\$4513

COM Yardage (Optional two fabrics): Backs: 2 Yds / Seats: 1.5 Yds

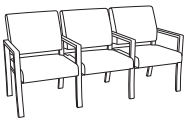

3110 Metal - 3-Seat Lounge w/Dividing Arms

COM Yardage: 5 Yds. Seat 2.5 Yd. / Back 2.5 Yds.

COM	GR1	GR2	GR3	GR4	GR5	GR6	GR7	GR8	GR9	GR10	LEA
\$3795	\$4061	\$4224	\$4393	\$4568	\$4751	\$4941	\$5139	\$5344	\$5559	\$5780	\$6832

COM Yardage (Optional two fabrics): Backs: 2.75 Yds / Seats: 2.5 Yds

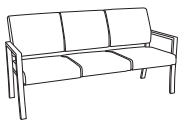

3111 Metal - 3-Seat Lounge

COM Yardage: 5 Yds. Seat 2.5 Yd. / Back 2.5 Yds.

COM	GR1	GR2	GR3	GR4	GR5	GR6	GR7	GR8	GR9	GR10	LEA
\$3618	\$3871	\$4025	\$4187	\$4353	\$4528	\$4709	\$4897	\$5094	\$5297	\$5509	\$6511

COM Yardage (Optional two fabrics): Backs: 2.75 Yds / Seats: 2.5 Yds

OPTIONS

Add upcharge to list price and code to model number

FR	CAL 133 (TB 133) Fire Retardant per yard	\$90/yd
MB	Moisture Barrier on seat	\$125
VMAC2	Polyurethane Arm Caps - Black	\$48 each
VMAC3	Polyurethane Arm Caps - Charcoal	\$48 each
VMAC4	Solid Surface Arm Caps - White	\$108 each
VMAC5	Solid Surface Arm Caps - Brown	\$108 each

VMAC7	Solid Surface Arm Caps - Beige	\$108 each
VMAC8	Solid Surface Arm Caps - Gray	\$108 each
VMAC6	Solid Wood Arm Caps	\$80 each
FM	Floor Mount	\$98 per unit
2FO/C	2 Fabric Option	\$49 per seat

DIMENSIONS	Two Seat Lounge	Two Seat Center Arm	Three Seat Lounge
Seat Width:	21"	21"	21"
Seat Depth:	19"	19"	19"
Seat Height:	17.5"	17.5"	17.5"
Back Height:	35"	35"	35"
Arm Height:	25.5"	25.5"	25.5"
Overall Width:	46"	48"	70.5"
Overall Depth:	28"	28"	28"
Qty./Wt. per carton:	1 ea./60 lbs.	1 ea./62 lbs.	1 ea./93 lbs.



VENTURA THREE-SEAT LOUNGE

MODEL / DESCRIPTION / LIST PRICING

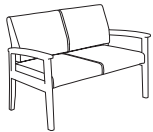

3022 Wood Two-Seat Lounge

COM Yardage: 4 Yds. Seat 2 Yds. / Back 2 Yds.

COM	GR1	GR2	GR3	GR4	GR5	GR6	GR7	GR8	GR9	GR10	LEA
\$1892	\$2025	\$2106	\$2190	\$2278	\$2369	\$2463	\$2563	\$2665	\$2772	\$2882	\$3406

COM Yardage (Optional two fabrics): Back: 2 Yds / Seat: 1.5 Yds

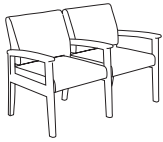

3023 Wood Two-Seat Lounge with Dividing Arm

COM Yardage: 4 Yds. Seat 2 Yd. / Back 2 Yds.

COM	GR1	GR2	GR3	GR4	GR5	GR6	GR7	GR8	GR9	GR10	LEA
\$2018	\$2159	\$2245	\$2335	\$2429	\$2526	\$2627	\$2732	\$2841	\$2954	\$3073	\$3632

COM Yardage (Optional two fabrics): Back: 2 Yds / Seat: 1.5 Yds

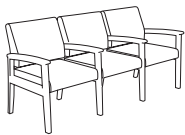

3025 Wood Three-Seat Lounge with Dividing Arms

COM Yardage: 5 Yds. Seat 2.5 Yds. / Back 2.5 Yds.

COM	GR1	GR2	GR3	GR4	GR5	GR6	GR7	GR8	GR9	GR10	LEA
\$2964	\$3171	\$3298	\$3430	\$3568	\$3710	\$3859	\$4012	\$4174	\$4340	\$4514	\$5334

COM Yardage (Optional two fabrics): Back: 2.75 Yds / Seat: 2.5 Yds

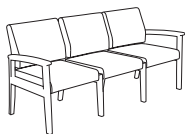

3026 Wood Three-Seat Lounge

COM Yardage: 5 Yds. Seat 2.5 Yd. / Back 2.5 Yds.

COM	GR1	GR2	GR3	GR4	GR5	GR6	GR7	GR8	GR9	GR10	LEA
\$3440	\$3681	\$3828	\$3981	\$4140	\$4306	\$4478	\$4658	\$4844	\$5037	\$5239	\$6192

COM Yardage (Optional two fabrics): Back: 2.75 Yds / Seat: 2.5 Yds

OPTIONS

Add upcharge to list price and code to model number

AG	Adjustable Glide	\$19/pair
FR	CAL 133 (TB 133) Fire Retardant per yard	\$90/yd
MB	Moisture Barrier on seat	\$125
2FO/C	2 Fabric Option	\$49 per seat

VWAC2	Polyurethane Arm Caps - Black	-
VWAC3	Polyurethane Arm Caps - Charcoal	-
VWAC6	Wood Arm Caps	\$80 each

VENTURA BENCH

The Ventura Bench features two and three seat benches on substantial metal and wood frames. Optional On-Line Tables can replace upholstered seat unit. Bench seating with your choice of fabric, laminate and wood or metal frame finish. Ideal for high use waiting areas.



METAL FRAME
3 SEAT WITH OPTIONAL
WOOD ARM CAPS



WOOD FRAME
3 SEAT WITH OPTIONAL WOOD ARM CAPS

ORDERING INFORMATION

To Order Please Specify:

- | | |
|-------------------------------|--------------------------|
| 1) Series Name | 5) Frame Color / Finish |
| 2) Model Number | 6) Fabric Grade & Number |
| 3) Quantity | 7) Optional Items |
| 4) Arm Cap Selection / Finish | |

VENTURA GENERAL SPECIFICATIONS

Metal Frame Construction

Frame is constructed of 1" x 2" rectangular tube steel, braze welded for extra strength – **tested for 750 lbs per single seat.** Built in wall saver design. No-sag springs are installed in seat along with interlocking helicoil springs to prevent sagging and provide support. Back is supported with ultraflex spring webbing.

Wood Frame Construction

The wood frame is constructed of solid Beech, re-enforced with welded steel frame seating supports. Built in wall saver design. No sag-springs are installed in seat along with interlocking helicoil springs to prevent sagging and provide support.

Upholstery

Ventura Bench has fully upholstered seats. Seat cushions are 2" graded high resiliency (H.R.) block foam, covered entirely with special bonded polyester fiber to protect final upholstery. ERG uses only water based glues and adhesives in our upholstery process. Seat is covered in choice of fabric, vinyl, crypton, leather or COM.

Arm Caps

Standard with rectangular tube metal Arms. Solid Wood, Polyurethane and Solid Surface Arm Caps optional.

Table Tops

Table tops are laminated on all sides with your choice of over 1000 standard laminates. Wood Veneer, Solid Surface and Acrylic also available.

Glides

Metal glides are installed on all benches.

COLORS / FINISHES

Metal Finish Colors:

Standard powder coat colors available.

Wood Stain Finish Colors:

All transparent wood stain colors available.

Wood Stain for optional wood arm caps:

All transparent wood stain colors available.

Wood Frame Arm Caps:

Unit comes standard with poly arm caps

- Black
- Charcoal

**Standard Polyurethane Arm Caps
(Wood Frame Only)**



BLACK POLY ARM CAP – **VWAC2**



CHARCOAL POLY ARM CAP – **VWAC3**

OPTIONS

METAL (VM)

- CODE: FR - CAL 133 (TB 133) Fire Retardant
- CODE: MB - Moisture Barrier
- CODE: 2FO/C - Two Fabric Option (per seat)
- CODE: FM - Floor Mount
- CODE: VMAC2 - Arm Caps, Black Polyurethane
- CODE: VMAC3 - Arm Caps, Charcoal Polyurethane
- CODE: VMAC4 - Arm Caps, White Solid Surface (Glacier White by Corian)
- CODE: VMAC5 - Arm Caps, Brown Solid Surface (Bronzite by Corian)
- CODE: VMAC7 - Arm Caps, Beige Solid Surface (Bone by Corian)
- CODE: VMAC8 - Arm Caps, Gray Solid Surface (Silver Grey by Corian)

WOOD (VW)

- CODE: VMAC6 - Arm Caps, Solid Wood
- CODE: FR - CAL 133 (TB 133) Fire Retardant
- CODE: MB - Moisture Barrier
- CODE: 2FO/C - Two Fabric Option (per seat)
- CODE: FM - Floor Mount
- CODE: VWAC6 - Wood Arm Caps

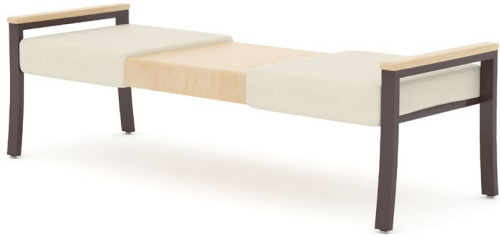

3 PIECE METAL UNIT WITH FLUSH CENTER TABLE AND OPTIONAL ARM CAPS



3 PIECE WOOD UNIT WITH FLUSH CENTER TABLE



3 PIECE WOOD UNIT WITH LOWERED CENTER TABLE



3 PIECE METAL UNIT WITH LOWERED CENTER TABLE AND OPTIONAL ARM CAPS

VENTURA BENCH
METAL FRAME - UPHOLSTERED SEAT/TABLE

DIMENSIONS	Two Seat	Three Seat	3118 w/Table	3120 w/Table
Overall Width:	46"	67"	67"	67"
Overall Depth:	25"	25"	25"	25"
Seat Height:	18"	18"	18"	18"
Arm Height:	21"	21"	21"	21"
Qty./Wt.:	1 ea./110 lbs.	1 ea./150 lbs.	1 ea./140 lbs.	1 ea./150 lbs.



METAL FRAME - 3 SEAT BENCH WITH
OPTIONAL WOOD ARM CAPS

MODEL / DESCRIPTION / LIST PRICING

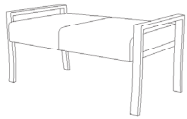

3114 Metal Two Seat Bench

COM Yardage: 2 Yds.

COM	GR1	GR2	GR3	GR4	GR5	GR6	GR7	GR8	GR9	GR10	LEA
\$2137	\$2287	\$2378	\$2473	\$2572	\$2675	\$2782	\$2893	\$3008	\$3130	\$3255	\$3848

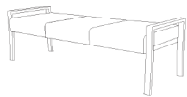

3116 Metal Three Seat Bench

COM Yardage: 3 Yds.

COM	GR1	GR2	GR3	GR4	GR5	GR6	GR7	GR8	GR9	GR10	LEA
\$3012	\$3223	\$3352	\$3486	\$3625	\$3770	\$3921	\$4078	\$4240	\$4411	\$4588	\$5422

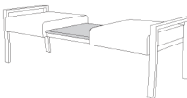

3118 Metal 3-Piece Unit w/Lowered Center Table & 3MM Edge Laminate

COM Yardage: 2 Yds.

COM	GR1	GR2	GR3	GR4	GR5	GR6	GR7	GR8	GR9	GR10	LEA
\$2793	\$2989	\$3108	\$3232	\$3362	\$3496	\$3635	\$3781	\$3932	\$4090	\$4253	\$5026

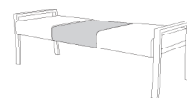

3120 Metal 3-Piece Unit w/Flush Center Table

COM Yardage: 2 Yds.

COM	GR1	GR2	GR3	GR4	GR5	GR6	GR7	GR8	GR9	GR10	LEA
\$3060	\$3272	\$3404	\$3540	\$3682	\$3829	\$3982	\$4142	\$4308	\$4480	\$4660	\$5507

OPTIONS

Add upcharge to list price and code to model number

FR	CAL 133 (TB 133) Fire Retardant per yard	\$90/yd
MB	Moisture Barrier per seat	\$125
VMAC2	Polyurethane Arm Caps - Black	\$58 each
VMAC3	Polyurethane Arm Caps - Charcoal	\$58 each
VMAC4	Solid Surface Arm Caps - White	\$108 each
VMAC5	Solid Surface Arm Caps - Brown	\$108 each

VMAC7	Solid Surface Arm Caps - Beige	\$108 each
VMAC8	Solid Surface Arm Caps - Gray	\$108 each
VMAC6	Solid Wood Arm Caps	\$80 each
FM	Floor Mount - per unit	\$98
2FO/C	2 Fabric Option	\$49 per seat

DIMENSIONS	Two Seat	Three Seat	3106 Table	3108 Table
Overall Width:	45"	66"	20.5"	20.5"
Overall Depth:	25"	25"	21.5"	24"
Seat Height:	18"	18"	-	-
Arm Height:	22"	22"	-	-
Qty./Wt.:	1 ea./45 lbs.	1 ea./65 lbs.	call	call



WOOD FRAME - 3 SEAT BENCH
WITH OPTIONAL WOOD ARM CAPS

MODEL / DESCRIPTION / LIST PRICING

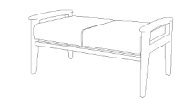

3040 Wood Two Seat Bench

COM Yardage: 2 Yds.

COM	GR1	GR2	GR3	GR4	GR5	GR6	GR7	GR8	GR9	GR10	LEA
\$2292	\$2454	\$2552	\$2654	\$2760	\$2870	\$2986	\$3104	\$3229	\$3358	\$3491	\$4127

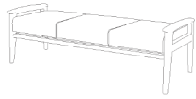

3041 Wood Three Seat Bench

COM Yardage: 3 Yds.

COM	GR1	GR2	GR3	GR4	GR5	GR6	GR7	GR8	GR9	GR10	LEA
\$3217	\$3442	\$3581	\$3722	\$3872	\$4028	\$4188	\$4356	\$4530	\$4711	\$4900	\$5791

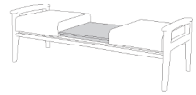

3042 Wood 3-Piece Unit w/Lowered Center Table & 3MM Edge Laminate

COM Yardage: 2 Yds.

COM	GR1	GR2	GR3	GR4	GR5	GR6	GR7	GR8	GR9	GR10	LEA
\$2988	\$3196	\$3325	\$3456	\$3595	\$3740	\$3889	\$4044	\$4205	\$4374	\$4550	\$5377

*For all other table surfaces call for price quote.

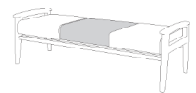

3043 Wood 3-Piece Unit w/Flush Center Table

COM Yardage: 2 Yds.

COM	GR1	GR2	GR3	GR4	GR5	GR6	GR7	GR8	GR9	GR10	LEA
\$3262	\$3491	\$3631	\$3777	\$3927	\$4084	\$4249	\$4418	\$4594	\$4779	\$4969	\$5874

*For all other table surfaces call for price quote.



WOOD ONLY!
WELDED STEEL CONSTRUCTION
Ventura Wood Lounge features a fully welded steel substructure for the ultimate in seating strength.

OPTIONS

Add upcharge to list price and code to model number

FR	CAL 133 (TB 133) Fire Retardant per yard	\$90/yd
MB	Moisture Barrier per seat	\$125
2FO/C	2 Fabric Option	\$49 per seat

VWAC2	Polyurethane Arm Caps - Black	-
VWAC3	Polyurethane Arm Caps - Charcoal	-
VWAC6	Wood Arm Caps in matching stain	\$80 each

VENTURA OCCASIONAL TABLES

Ventura Tables are topped with laminate, wood veneer or a solid surface on stylish steel frame which coordinates with our Ventura Seating.



METAL



METAL
MIDDLE ON-LINE TABLE



METAL
QUARTER ROUND ON-LINE TABLE



METAL
END (L or R) ON-LINE TABLE



METAL
FLUSH TOP - FT

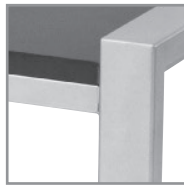

METAL
LOWERED TOP - LT



METAL FRAME
COFFEE TABLE 42" or 60"

WOOD



WOOD
MIDDLE ON-LINE TABLE



WOOD
END (L or R) ON-LINE TABLE



WOOD FRAME
COFFEE TABLE 42" or 60"

ORDERING INFORMATION

To Order Please Specify:

- 1) Series Name
- 2) Model Number
- 3) Quantity
- 4) Select Table Top Material
- 5) Select Table Top Option (Flush or Lowered)
- 6) Edge Style Selection and Color
- 7) Select Frame Finish:
Metal - All ERG Powdercoats
Wood - All ERG Wood Stains

VENTURA SPECIFICATIONS

Table Tops

Laminate tops are .75" overall thickness and finished with high pressure laminate. ERG offers over 1000 standard laminate choices from Nevamar, Wilsonart, Formica and Pionite. Wood veneer (maple) may be stained in any of ERG's transparent wood stain colors.

Note: Solid Surface tops are .75" thick, acrylic tops are 1" thick and are both quoted upon request.

Metal Frame

Metal table legs are made of 14 gauge 1" x 2" steel tubing. Table frames are sandblasted and finished in your choice of standard powder coat colors.

Wood Frame

Frame and Legs are constructed of Maple, available in standard transparent wood stain colors.

Glides

Metal self leveling glides are factory installed.







OCCASIONAL TABLE
WITH LOWERED TOP

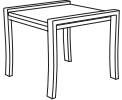

ONLINE TABLE
WITH FLUSH TOP

MODEL / DESCRIPTION / LIST PRICING

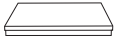
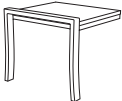
VENTURA METAL OCCASIONAL TABLES

	Model Number	Model Description	Table Top Size	Table Height	Table Top Shape	Shipping Weight	LAMINATE EDGE 2B OR 3A	WOOD VENEER EDGE 8G
	VM2122	Occasional	21.5" x 22"	18"	square	55 lbs	\$1092	\$1268
	VM2142	Occasional	21.5" x 42"	18"	rectangular	70 lbs	\$1504	\$1775
	VM2160	Occasional	21.5" x 60"	18"	rectangular	75 lbs	\$1663	\$1893
	VMO2122	Online Table	21" x 22"	15.5"	square	15 lbs	\$673	\$827
	VM2122R	Online Table	21" x 22"	15.5"	square	30 lbs	\$903	\$1044
	VM2122L	Online Table (Right/Left - When seated)	21" x 22"	15.5"	square	30 lbs	\$903	\$1044
	VM26Q	Online Table	26" x 26"	15.5"	quarter round	30 lbs	\$967	\$1125

OPTIONS





Add upcharge to list price and code to model number

FT	Flush Table Top	NC	LT	Lowered Table Top	NC
----	-----------------	----	----	-------------------	----

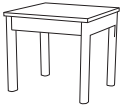

MODEL / DESCRIPTION / LIST PRICING

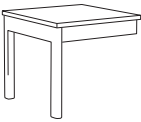
VENTURA WOOD OCCASIONAL TABLES

	Model Number	Model Description	Table Top Size	Table Height	Table Top Shape	Shipping Weight	LAMINATE EDGE 2B OR 3A	WOOD VENEER EDGE 8G
	VW20S	Occasional	20" x 20"	18"	square	50 lbs	\$1053	\$1220
	VW2042	Occasional	20" x 42"	18"	rectangular	70 lbs	\$1454	\$1643
	VW2060	Occasional	20" x 60"	18"	rectangular	75 lbs	\$1610	\$1785
	VWO2120	Occasional	21.5" x 20"	15.5"	square	15 lbs	\$747	\$894
	VW20SR	Occasional	20" x 20"	15.5"	square	30 lbs	\$979	\$1134
	VW20SL	Occasional	20" x 20"	15.5"	square	30 lbs	\$979	\$1134
		(Right/Left - When seated)						
	VW26Q	Occasional	26.5" x 26.5"	15.5"	quarter round	25 lbs	\$1076	\$1250



METAL



WOOD

CONFIGURATIONS USING ONLINE TABLES AVAILABLE

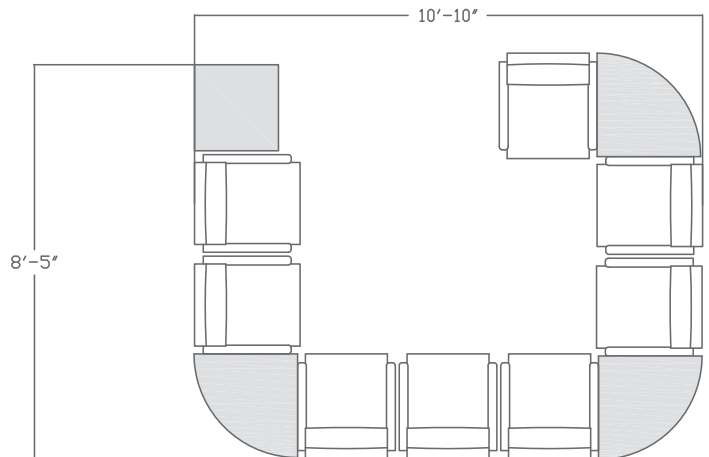
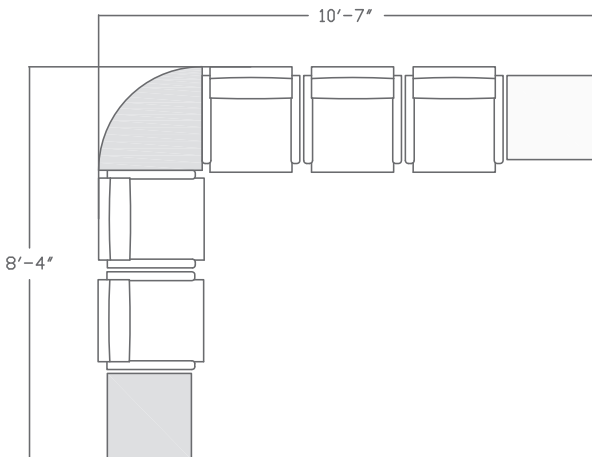
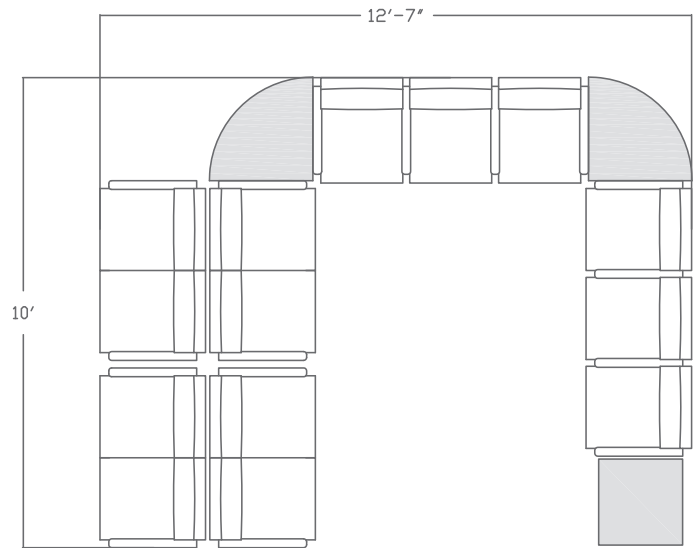
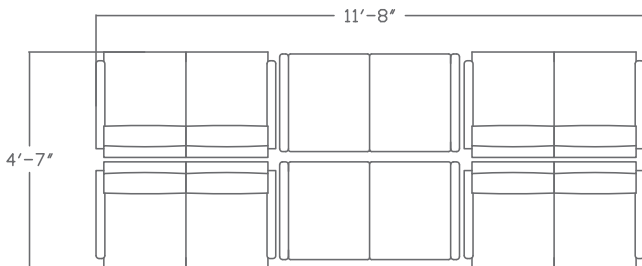
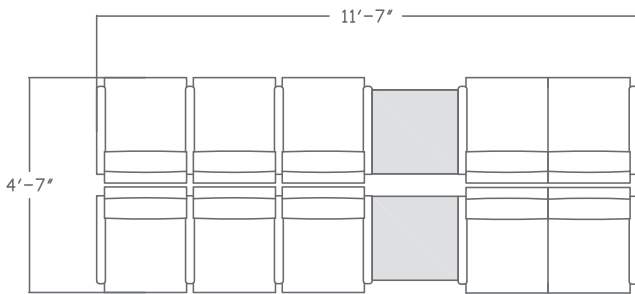

CAD Design and Engineering services per your specifications are available to customers requesting this service.
Please provide exact room dimensions, desired configuration and seating requirements and fax your order to
ERG Customer Service: 1-805-981-9878 or call toll free: 1-800-446-1186