



BRIGHTON TABLE OF CONTENTS

Brighton Specifications	2
Brighton Options	3
Brighton Steps Pricing	4
Brighton Modular Pricing	6
Brighton Backless Modular Pricing	9
Brighton Lounge Pricing	10
Brighton Upholstered Table Pricing	11
Brighton Arms Pricing	12
Brighton Steps Dimensions	13
Brighton Jr. Pricing	14
Brighton Configuration Layouts	16
Brighton Fabric Placement	17

BRIGHTON STEPS • BRIGHTON MODULAR • BRIGHTON LOUNGE

Brighton is an inspiring collection offering modular lounge in both conventional and non-traditional environments. The emphasis is on meeting spaces at all levels, with a more relaxed and inviting platform. Functional power options can be specified for added convenience. Gathering together with Brighton will create a natural, comfortable and simple space for collaboration.



ORDERING INFORMATION

To Order Please Specify:

- 1) Series Name
- 2) Model Number
- 3) Quantity
- 4) Fabric Grade and Number
- 5) Optional Items
- 6) Laminate Step Choice
- 7) Optional Flat Back (Step Units)

GENERAL SPECIFICATIONS

Frame

- Multi-ply hardwood
- Tongue and groove construction nailed and glued

Seat/Foam

- No-sag springs with interlocking helicoil springs for additional seat and low back support
- High resiliency foam construction throughout
- All foam bonded to frame

CURVED BACK
IS STANDARD
ON ALL
BRIGHTON
UNITS



SOFT SEATING	WEIGHT LIMIT
1 Seat	500 lbs.
2 Seat	1000 lbs.
3 Seat	1500 lbs.

OPTIONS

- CODE: FR - CAL 133 (TB 133) Fire Retardant
- CODE: MB - Moisture Barrier (1"-59"width)
- CODE: MB60 - Moisture Barrier (60"and up)
- CODE: MB2S - Moisture Barrier (2 step units)
- CODE: MB3S - Moisture Barrier (3 step units)
- CODE: 2FO - Two Fabric Option
- CODE: 3FO - Three Fabric Option
- CODE: GD2 - Flat Ganging Device for Soft Seating
- CODE: TAB-() - Non-Removable Swivel Tablet
(shape A, B or C, left or right arm)
- CODE: TABR1-() - Removable Swivel Tablet
(laminated shape A, B or C specify left or right arm)
- CODE: TABR2-() - Removable Swivel Tablet
(laminated shape A, B or C with opening for tablet on both arms)
- CODE: TABFB-() - Fixed Blade Tablet
(outside or inside, specify (L/R), shape A, B or C)
- CODE: SST - Solid Surface Tablet Arm
- CODE: BFS - Laminated Full Step Top (not available on top step of 3)
- CODE: BFB - Flat Back On Steps Units (for back-to-back application)
- CODE: LAM5 - Non-standard laminate for 5 or less tablets
see options for upcharge
- CODE: SS5 - Non-standard Solid Surface top for 5 or less tablets

OPTIONAL FLAT BACK ON STEPS

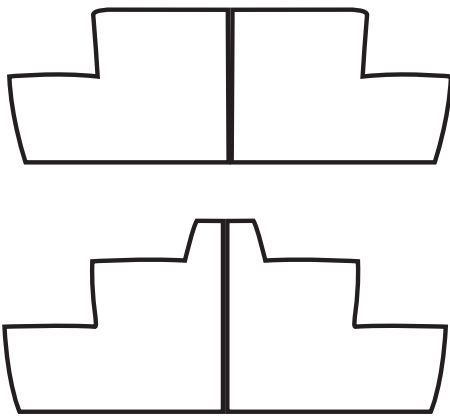

THIS OPTION HIGHLY RECOMMENDED FOR BACK TO BACK APPLICATIONS



.75" LAMINATE FULL STEP TOP ON STRAIGHT UNITS ONLY

NOTE: LAMINATE TOP NOT AVAILABLE ON TOP STEP OF THREE-STEP UNIT

DIMENSIONS	30" Straight 2 Step	36" Straight 2 Step	44" Straight 2 Step	30° Curved 2 Step	Corner 2 Step
Step 1 Depth:	13"	13"	13"	13"	13"
Step 2 Depth:	21"	21"	21"	21"	21"
Step 1 Height:	14"	14"	14"	14"	14"
Step 2 Height:	24"	24"	24"	24"	24"
Overall Depth:	34"	34"	34"	34"/37"	36"
Overall Width:	30"	36"	44"	62"	36"
Overall Height:	24"	24"	24"	24"	24"
Qty./Wt.:	1 ea./57 lbs.	1 ea./63 lbs.	1 ea./73 lbs.	1 ea./110 lbs.	1 ea./78 lbs.



2 STEP STRAIGHT
TWO FABRIC OPTION



2 STEP CORNER

MODEL / DESCRIPTION / LIST PRICING

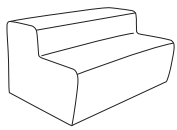

7397 30" straight-2 step

COM Yardage: Total: 5.75 Yds. / Steps: 2.5 Yds. / Sides: 2 Yds. / Back: 1.25 Yds.

COM	GR1	GR2	GR3	GR4	GR5	GR6	GR7	GR8	GR9	GR10	LEA
\$3020	\$3267	\$3418	\$3582	\$3806	\$3971	\$4136	\$4301	\$4467	\$4632	\$4796	\$4966

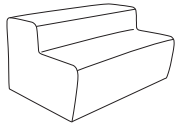

7399 36" straight-2 step

COM Yardage: Total: 5.75 Yds. / Steps: 2.5 Yds. / Sides: 2 Yds. / Back: 1.25 Yds.

COM	GR1	GR2	GR3	GR4	GR5	GR6	GR7	GR8	GR9	GR10	LEA
\$3199	\$3447	\$3598	\$3762	\$3987	\$4151	\$4315	\$4481	\$4644	\$4810	\$4977	\$5148

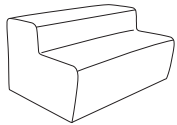

7371 44" Straight 2 Step Unit

COM Yardage: Total: 6.5 Yds. / Steps: 3 Yds. / Sides: 2 Yds. / Back: 1.5 Yds.

COM	GR1	GR2	GR3	GR4	GR5	GR6	GR7	GR8	GR9	GR10	LEA
\$3358	\$3849	\$4033	\$4232	\$4503	\$4706	\$4904	\$5105	\$5302	\$5504	\$5703	\$5910

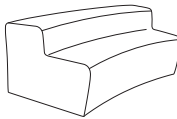

7373 Curved 2 Step Unit

COM Yardage: Total: 9 Yds. / Steps: 4.75 Yds. / Sides: 2 Yds. / Back: 2.25 Yds.

COM	GR1	GR2	GR3	GR4	GR5	GR6	GR7	GR8	GR9	GR10	LEA
\$3694	\$4184	\$4366	\$4568	\$4840	\$5039	\$5240	\$5438	\$5639	\$5840	\$6038	\$6248

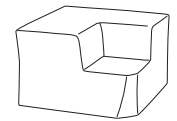

7375 Corner 2 Step Unit

COM Yardage: Total: 9.25 Yds. / Steps: 4.75 Yds. / Sides: 2 Yds. / Back: 2.5 Yds.

COM	GR1	GR2	GR3	GR4	GR5	GR6	GR7	GR8	GR9	GR10	LEA
\$5153	\$5616	\$5775	\$5949	\$6188	\$6362	\$6536	\$6713	\$6888	\$7061	\$7236	\$7419

NOTE: .75" LAMINATE FULL STEP TOP ON STRAIGHT UNITS ONLY

OPTIONS

Add upcharge to list price and code to model number

FR	CAL 133 (TB 133) Fire Retardant per yard	\$128	/yd.	3FO	Three fabric option	\$215	
MB2S	Moisture Barrier - 2 Step Unit	\$267	ea.	BFB	Flat Back - Step Unit (For Back-to-back)	\$128	
GD2	Flat Ganging Device for Soft Seating	\$121	per pair	BFSM	Laminate Top Full Step - Multi-ply Edge	\$821	
2FO	Two Fabric Option	\$141		TABFB-()	Fixed Blade Tablet (outside or inside, specify (L/R), shape A, B or C)	\$642	ea. tablet

DIMENSIONS	30" Straight 3 Step	36" Straight 3 Step	44" Straight 3 Step	30° Curve 3 Step	Corner 3 Step
Step 1 Depth:	13"	13"	13"	13"	13"
Step 2 Depth:	14"	14"	14"	14"	14"
Step 3 Depth:	4"	4"	4"	4"	4"
Step 1 Height:	14"	14"	14"	14"	14"
Step 2 Height:	24"	24"	24"	24"	24"
Overall Depth:	34"	34"	34"	34"/37"	36"
Overall Width:	30"	36"	44"	62"	36"
Overall Height:	30"	30"	30"	30"	30"
Qty./Wt.:	1 ea./65 lbs.	1 ea./71 lbs.	1 ea./81 lbs.	1 ea./110 lbs.	1 ea./78 lbs.



3 STEP CURVE
TWO FABRIC OPTION



3 STEP CORNER
TWO FABRIC OPTION

MODEL / DESCRIPTION / LIST PRICING

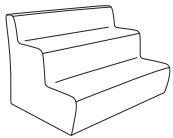

7393 30" straight-3 step

COM Yardage: Total: 6.5 Yds. / Steps: 3.25 Yds. / Sides: 2 Yds. / Back: 1.25 Yds.

COM	GR1	GR2	GR3	GR4	GR5	GR6	GR7	GR8	GR9	GR10	LEA
\$3349	\$3536	\$3664	\$3830	\$4128	\$4293	\$4458	\$4625	\$4788	\$4953	\$5116	\$5291

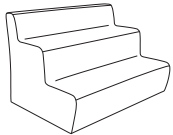

7395 36" straight-3 step

COM Yardage: Total: 6.5 Yds. / Steps: 3.25 Yds. / Sides: 2 Yds. / Back: 1.25 Yds.

COM	GR1	GR2	GR3	GR4	GR5	GR6	GR7	GR8	GR9	GR10	LEA
\$3618	\$3806	\$3935	\$4098	\$4398	\$4562	\$4730	\$4895	\$5057	\$5223	\$5388	\$5560

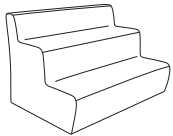

7370 44" Straight 3 Step Unit

COM Yardage: Total: 6.5 Yds. / Steps: 3 Yds. / Sides: 2 Yds. / Back: 1.5 Yds.

COM	GR1	GR2	GR3	GR4	GR5	GR6	GR7	GR8	GR9	GR10	LEA
\$3812	\$4113	\$4293	\$4494	\$4856	\$5056	\$5257	\$5457	\$5657	\$5856	\$6057	\$6268

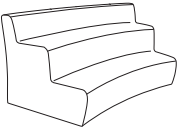

7372 30° Curve 3 Step Unit

COM Yardage: Total: 11.75 Yds. / Steps: 7.5 Yds. / Sides: 2 Yds. / Back: 2.25 Yds.

COM	GR1	GR2	GR3	GR4	GR5	GR6	GR7	GR8	GR9	GR10	LEA
\$4196	\$4494	\$4677	\$4876	\$5240	\$5438	\$5639	\$5840	\$6038	\$6240	\$6438	\$6649

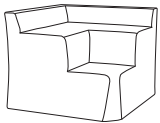

7374 Corner 3 Step Unit

COM Yardage: Total: 11.5 Yds. / Steps: 7 Yds. / Sides: 2 Yds. / Back: 2.5 Yds.

COM	GR1	GR2	GR3	GR4	GR5	GR6	GR7	GR8	GR9	GR10	LEA
\$5673	\$6212	\$6371	\$6545	\$6862	\$7038	\$7211	\$7386	\$7562	\$7736	\$7911	\$8094

NOTE: .75" LAMINATE FULL STEP TOP ON STRAIGHT UNITS ONLY
LAMINATE TOP NOT AVAILABLE ON TOP STEP OF THREE-STEP UNIT

DISCLAIMER: THIRD STEP IS TO BE USED AS BACKREST ONLY, DO NOT STAND OR SIT ON THIRD STEP. FAILURE TO COMPLY WITH THIS DISCLAIMER COULD RESULT IN SERIOUS BODILY INJURY.

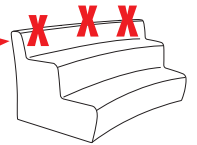

OPTIONS

Add upcharge to list price and code to model number

FR	CAL 133 (TB 133) Fire Retardant per yard	\$128	/yd.
MB3S	Moisture Barrier - 3 Step Unit	\$382	ea.
GD2	Flat Ganging Device for Soft Seating	\$121	per pair
2FO	Two Fabric Option	\$141	

3FO	Three fabric option	\$215	
BFB	Flat Back - Step Unit (For Back-to-back)	\$128	
BFSM	Laminate Top Full Step - Multi-ply Edge	\$821	

DIMENSIONS	22" Straight	30" Straight	44" Straight	Corner
Seat Depth:	20"	20"	20"	20"
Seat Width:	22"	30"	44"	20"
Seat Height:	17"	17"	17"	17"
Overall Depth:	27"	27"	27"	28"
Overall Width:	22"	30"	44"	28"
Overall Height:	30"	30"	30"	30"
Qty./Wt.:	1 ea./75 lbs.	1 ea./90 lbs.	1 ea./110 lbs.	1 ea./82 lbs.



TWO SEAT MODULAR

MODEL / DESCRIPTION / LIST PRICING

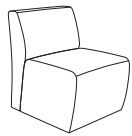

7359 22" Straight Unit

COM Yardage: Total: 3.5 Yds. / Back: 2 Yds. / Seat: 1.5 Yds.

COM	GR1	GR2	GR3	GR4	GR5	GR6	GR7	GR8	GR9	GR10	LEA
\$1678	\$1799	\$1922	\$2060	\$2179	\$2321	\$2458	\$2597	\$2733	\$2874	\$3011	\$3211

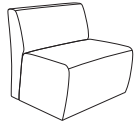

7360 30" Straight Unit

COM Yardage: Total: 5 Yds. / Back: 2.5 Yds. / Seat: 2.5 Yds.

COM	GR1	GR2	GR3	GR4	GR5	GR6	GR7	GR8	GR9	GR10	LEA
\$2000	\$2149	\$2302	\$2478	\$2633	\$2806	\$2981	\$3153	\$3326	\$3501	\$3708	\$3906

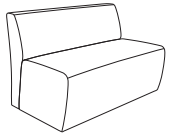

7361 44" Straight Unit

COM Yardage: Total: 7 Yds. / Back: 3.5 Yds. / Seat: 3.5 Yds.

COM	GR1	GR2	GR3	GR4	GR5	GR6	GR7	GR8	GR9	GR10	LEA
\$2794	\$3001	\$3208	\$3419	\$3626	\$3833	\$4043	\$4251	\$4458	\$4666	\$4874	\$5074

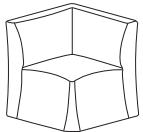

7368 Corner Unit

COM Yardage: Total: 6 Yds. / Back: 4 Yds. / Seat: 2 Yds.

COM	GR1	GR2	GR3	GR4	GR5	GR6	GR7	GR8	GR9	GR10	LEA
\$2874	\$3063	\$3237	\$3428	\$3603	\$3792	\$3985	\$4175	\$4365	\$4556	\$4746	\$4946

OPTIONS

Add upcharge to list price and code to model number

FR	CAL 133 (TB 133) Fire Retardant per yard	\$128	/yd.	3FO	Three fabric option	\$215	
MB	Moisture Barrier (1"-59"width)	\$178	ea.	TABFB-()	Fixed Blade Tablet (outside or inside, specify (L/R), shape A, B or C)	\$642	ea. tablet
GD2	Flat Ganging Device for Soft Seating	\$121	per pair	LAM5	Non-standard laminate (5 tablets or less)	\$599	ea. tablet
2FO	Two Fabric Option	\$141		SST	Solid Surface Tablet - add to tablet option	\$293	ea. tablet

DIMENSIONS	30° Curve Inside	45° Curve Inside	60° Curve Inside
Seat Depth:	20"	20"	20"
Seat Width:	17"	25"	33"
Seat Height:	17"	17"	17"
Overall Depth:	27"/28"	27"/29.5"	27"/31.5"
Overall Width:	31"	46"	60"
Overall Height:	30"	30"	30"
Qty./Wt.:	1 ea./75 lbs.	1 ea./92 lbs.	1 ea./110 lbs.



60° INSIDE CURVE

MODEL / DESCRIPTION / LIST PRICING



7362 30° Inside Curve Unit

COM Yardage: Total: 4.25 Yds. / Back: 2.5 Yds. / Seat: 1.75 Yds.

COM	GR1	GR2	GR3	GR4	GR5	GR6	GR7	GR8	GR9	GR10	LEA
\$1844	\$1964	\$2086	\$2225	\$2347	\$2484	\$2624	\$2762	\$2902	\$3041	\$3180	\$3378

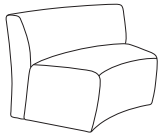

7363 45° Inside Curve Unit

COM Yardage: Total: 6.5 Yds. / Back: 3.5 Yds. / Seat: 3 Yds.

COM	GR1	GR2	GR3	GR4	GR5	GR6	GR7	GR8	GR9	GR10	LEA
\$2984	\$3100	\$3217	\$3349	\$3466	\$3601	\$3733	\$3867	\$3997	\$4132	\$4265	\$4461

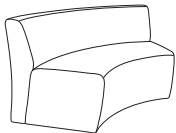

7364 60° Inside Curve Unit

COM Yardage: Total: 8 Yds. / Back: 4.5 Yds. / Seat: 3.5 Yds.

COM	GR1	GR2	GR3	GR4	GR5	GR6	GR7	GR8	GR9	GR10	LEA
\$3503	\$3673	\$3848	\$4039	\$4212	\$4401	\$4592	\$4781	\$4975	\$5165	\$5356	\$5556

OPTIONS

Add upcharge to list price and code to model number

FR	CAL 133 (TB 133) Fire Retardant per yard	\$128	/yd.
MB	Moisture Barrier (1"-59"width)	\$178	ea.
MB60	Moisture Barrier (60"and up)	\$283	ea.
GD2	Flat Ganging Device for Soft Seating	\$121	per pair
2FO	Two Fabric Option	\$141	

3FO	Three fabric option	\$215	
TABFB- ()	Fixed Blade Tablet (outside or inside, specify (L/R), shape A, B or C)	\$642	ea. tablet
LAM5	Non-standard laminate (5 tablets or less)	\$599	ea. tablet
SST	Solid Surface Tablet - add to tablet option	\$293	ea. tablet

DIMENSIONS	30° Curve Outside	45° Curve Outside	60° Curve Outside
Seat Depth:	20"	20"	20"
Seat Height:	17"	17"	17"
Back Height:	13"	13"	13"
Overall Depth:	27"/28"	27"/29.5"	27"/32"
Overall Width:	31"	46"	60"
Overall Height:	30"	30"	30"
Qty./Wt.:	1 ea./75 lbs.	1 ea./92 lbs.	1 ea./110 lbs.



60° OUTSIDE CURVE WITH
TWO FABRIC OPTION

MODEL / DESCRIPTION / LIST PRICING



7365 30° Outside Curve Unit

COM Yardage: Total: 4.5 Yds. / Back: 2 Yds. / Seat: 2.5 Yds.

COM	GR1	GR2	GR3	GR4	GR5	GR6	GR7	GR8	GR9	GR10	LEA
\$2063	\$2201	\$2323	\$2460	\$2583	\$2722	\$2860	\$2998	\$3137	\$3276	\$3415	\$3614

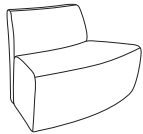

7366 45° Outside Curve Unit

COM Yardage: Total: 7 Yds. / Back: 3 Yds. / Seat: 4 Yds.

COM	GR1	GR2	GR3	GR4	GR5	GR6	GR7	GR8	GR9	GR10	LEA
\$3108	\$3240	\$3360	\$3492	\$3610	\$3743	\$3876	\$4010	\$4144	\$4276	\$4410	\$4600

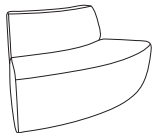

7367 60° Outside Curve Unit

COM Yardage: Total: 8 Yds. / Back: 3.5 Yds. / Seat: 4.5 Yds.

COM	GR1	GR2	GR3	GR4	GR5	GR6	GR7	GR8	GR9	GR10	LEA
\$3615	\$3807	\$3981	\$4172	\$4344	\$4534	\$4725	\$4916	\$5107	\$5298	\$5488	\$5685

OPTIONS

Add upcharge to list price and code to model number

FR	CAL 133 (TB 133) Fire Retardant per yard	\$128	/yd.
MB	Moisture Barrier (1"-59"width)	\$178	ea.
MB60	Moisture Barrier (60"and up)	\$283	ea.
GD2	Flat Ganging Device for Soft Seating	\$121	per pair
2FO	Two Fabric Option	\$141	

3FO	Three fabric option	\$215	
TABFB-()	Fixed Blade Tablet (outside or inside, specify (L/R), shape A, B or C)	\$642	ea. tablet
LAM5	Non-standard laminate (5 tablets or less)	\$599	ea. tablet
SST	Solid Surface Tablet - add to tablet option	\$293	ea. tablet

DIMENSIONS	Single Seat Backless	Two Seat Backless	Backless Curve
Overall Depth:	27"	27"	27"/28"
Overall Width:	22"	44"	25"
Overall Height:	17"	17"	17"
Qty./Wt.:	1 ea./75 lbs.	1 ea./110 lbs.	1 ea./90 lbs.

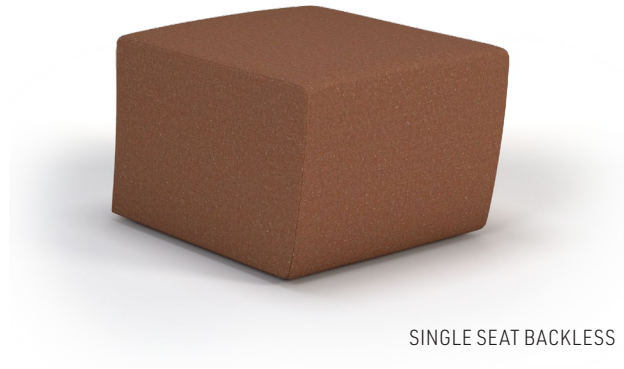

SINGLE SEAT BACKLESS

MODEL / DESCRIPTION / LIST PRICING

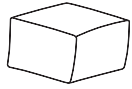

7350 22" Single Seat Backless Unit

COM Yardage: Total: 2.5 Yds. / Top: 1 Yds. / Sides: 1.5 Yds.

COM	GR1	GR2	GR3	GR4	GR5	GR6	GR7	GR8	GR9	GR10	LEA
\$1480	\$1602	\$1721	\$1860	\$1983	\$2122	\$2258	\$2399	\$2536	\$2675	\$2813	\$3014

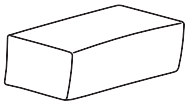

7352 44" Two Seat Backless Unit

COM Yardage: Total: 4 Yds. / Top: 1.5 Yds. / Sides: 2.5 Yds.

COM	GR1	GR2	GR3	GR4	GR5	GR6	GR7	GR8	GR9	GR10	LEA
\$2446	\$2654	\$2862	\$3070	\$3278	\$3486	\$3695	\$3903	\$4112	\$4319	\$4527	\$4726

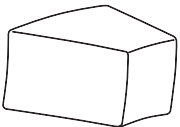

7354 30° Backless Curve

COM Yardage: Total: 2.5 Yds. / Top: 1 Yds. / Sides: 1.5 Yds.

COM	GR1	GR2	GR3	GR4	GR5	GR6	GR7	GR8	GR9	GR10	LEA
\$1729	\$1852	\$1972	\$2113	\$2232	\$2371	\$2510	\$2648	\$2786	\$2925	\$3063	\$3263

OPTIONS

Add upcharge to list price and code to model number

FR	CAL 133 (TB 133) Fire Retardant per yard	\$128	/yd.
MB	Moisture Barrier (1"-59"width)	\$178	ea.
GD2	Flat Ganging Device for Soft Seating	\$121	per pair
2FO	Two Fabric Option	\$141	

3FO	Three fabric option	\$215	
TABFB- ()	Fixed Blade Tablet (outside or inside, specify (L/R), shape A, B or C)	\$642	ea. tablet
LAM5	Non-standard laminate (5 tablets or less)	\$599	ea. tablet
SST	Solid Surface Tablet - add to tablet option	\$293	ea. tablet

DIMENSIONS	Single Seat	Two Seat
Seat Depth:	20"	20"
Seat Width:	22"	44"
Seat Height:	17"	17"
Overall Depth:	27"	27"
Overall Width:	28"	50"
Overall Height:	30"	30"
Qty./Wt.:	1 ea./115 lbs.	1 ea./130 lbs.



TWO SEAT LOUNGE

MODEL / DESCRIPTION / LIST PRICING

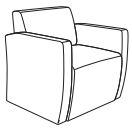

7390 Single Seat Lounge (Features Curved Back)

COM Yardage: Total: 6.5 Yds. / Back: 2 Yds. / Seat: 1.5 Yds. / Arms 3 Yds.

COM	GR1	GR2	GR3	GR4	GR5	GR6	GR7	GR8	GR9	GR10	LEA
\$2578	\$2945	\$3256	\$3428	\$3583	\$3757	\$3898	\$4069	\$4244	\$4416	\$4625	\$4970



7392 Two Seat Lounge (Features Curved Back)

COM Yardage: Total: 9 Yds. / Back: 3.5 Yds. / Seat: 2.5 Yds. / Arms 3 Yds.

COM	GR1	GR2	GR3	GR4	GR5	GR6	GR7	GR8	GR9	GR10	LEA
\$3868	\$4354	\$4562	\$4769	\$5032	\$5238	\$5446	\$5655	\$5863	\$6069	\$6278	\$6728

TABLET SHAPES

Three Tablet Shapes:

Choose from the three shapes shown and specify; A, B or C and left or right (outside tablet) when ordering.

Example: TABF-(A) Left - this would be a fixed shape A tablet on the left side (when seated).

Laminate Top: Tops are 3/4"

Tablet orders of 5 or less have 4 standard laminate colors:

- Wilsonart Black 1595-60
- Formica Swede Rift Oak 8676-26
- Formica Brite White 459-58
- Wilsonart Florence Walnut 7993-38

Edge: 6F Multi-Ply

Solid Surface Top:

Tablet orders of 5 or less have 2 standard Corian colors:

- Bone
- Glacier White

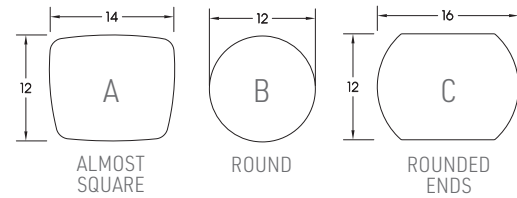

OPTIONS

Add upcharge to list price and code to model number

FR	CAL 133 (TB 133) Fire Retardant per yard	\$128	/yd.	TABR1-()	Removable Tablet (specify A, B or C, left or right arm)	\$817	ea. tablet
MB	Moisture Barrier (1"-59"width)	\$178	ea.	TABR2-()	Removable Tablet (specify A, B or C both arm openings)	\$966	ea. tablet
2FO	Two Fabric Option	\$141		SST	Solid Surface Tablet - Add To Tablet Option	\$293	ea. tablet
3FO	Three Fabric Option	\$215		SS5	Non-standard Solid Surface (5 tablets or less)	Call For Quote	
TAB-()	Swivel Tablet (Non-Removable (specify A, B or C, left or right arm)	\$706		LAM5	Non-standard laminate (5 tablets or less)	\$599	ea. tablet

DIMENSIONS	22" x 27"	30° Curve
Overall Depth:	27"	27"/28"
Overall Width:	22"	25"
Overall Height:	15"	15"
Qty./Wt.:	1 ea./75 lbs.	1 ea./90 lbs.

Laminate Top Note:

- Tops are 3/4" laminate
- Std with 6F multi-exposed core



30° UPHOLSTERED TABLE

MODEL / DESCRIPTION / LIST PRICING

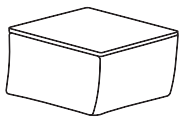

7350-T 22" Straight

COM Yardage: Total: 1.5 Yds.

COM	GR1	GR2	GR3	GR4	GR5	GR6	GR7	GR8	GR9	GR10	LEA
\$2553	\$2669	\$2784	\$2915	\$3030	\$3164	\$3296	\$3428	\$3560	\$3692	\$3823	\$4015

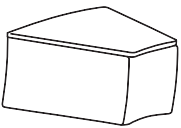

7354-T 30° Curve

COM Yardage: Total: 1.75 Yds.

COM	GR1	GR2	GR3	GR4	GR5	GR6	GR7	GR8	GR9	GR10	LEA
\$2898	\$3014	\$3129	\$3263	\$3376	\$3507	\$3641	\$3772	\$3906	\$4037	\$4170	\$4361

OPTIONS

Add upcharge to list price and code to model number

FR	CAL 133 (TB 133) Fire Retardant per yard	\$128	/yd.
MB	Moisture Barrier (1"-59"width)	\$178	ea.
GD2	Flat Ganging Device for Soft Seating	\$121	per pair

2FO	Two Fabric Option	\$141	
3FO	Three Fabric Option	\$215	

DIMENSIONS	Left or Right Arm	Center Arm
Overall Depth:	19"	19"
Overall Width:	3"	3"
Overall Height:	25"	25"
Qty./Wt.:	1 ea./20 lbs.	1 ea./10 lbs.



MODEL / DESCRIPTION / LIST PRICING

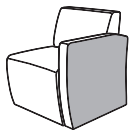

7388L Left Outside Arm

COM Yardage: Total: 1.5 Yds.

COM	GR1	GR2	GR3	GR4	GR5	GR6	GR7	GR8	GR9	GR10	LEA
\$381	\$451	\$505	\$572	\$624	\$677	\$727	\$780	\$851	\$917	\$988	\$1143

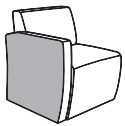

7388R Right Outside Arm

COM Yardage: Total: 1.5 Yds.

COM	GR1	GR2	GR3	GR4	GR5	GR6	GR7	GR8	GR9	GR10	LEA
\$381	\$451	\$505	\$572	\$624	\$677	\$727	\$780	\$851	\$917	\$988	\$1143

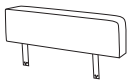

7388C Center Arm

COM Yardage: Total: 1 Yds.

COM	GR1	GR2	GR3	GR4	GR5	GR6	GR7	GR8	GR9	GR10	LEA
\$376	\$446	\$496	\$564	\$618	\$670	\$722	\$776	\$840	\$912	\$982	\$1137

OPTIONS

Add upcharge to list price and code to model number

FR	CAL 133 (TB 133) Fire Retardant per yard	\$128	/yd.
MB	Moisture Barrier (1"-59"width)	\$178	ea.

GD2	Flat Ganging Device for Soft Seating	\$121	per pair
2FO	Two Fabric Option	\$141	

THREE-STEPS DIMENSIONS

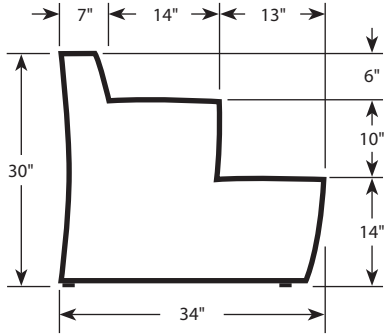

TWO-STEPS DIMENSIONS

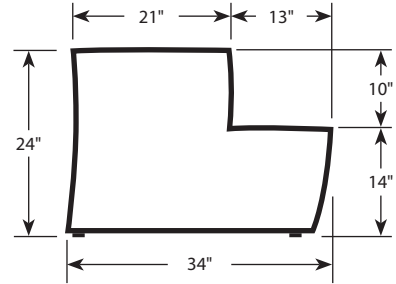

Step Unit Note:

Step units are also available with optional flat back, ideal for back-to-back applications

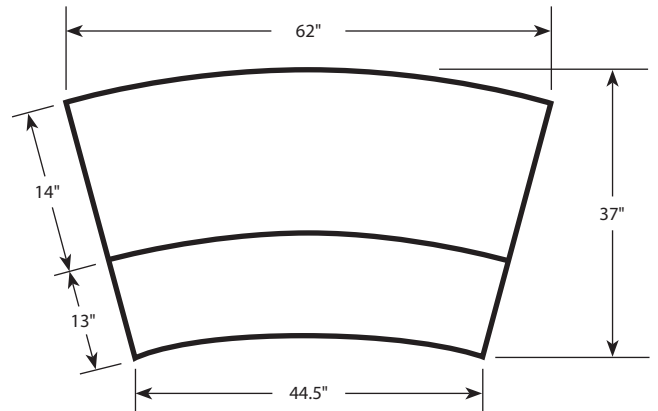
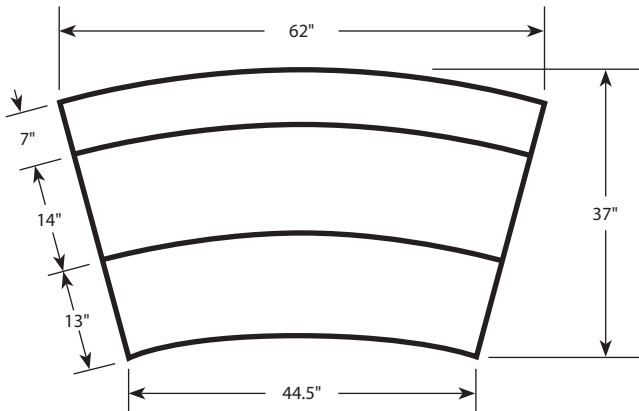
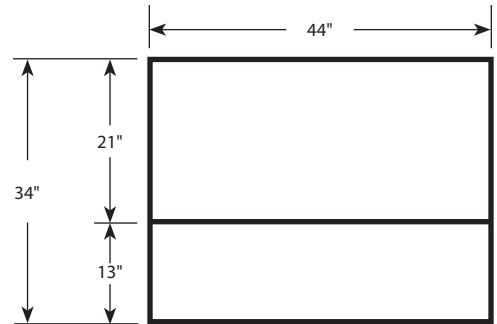
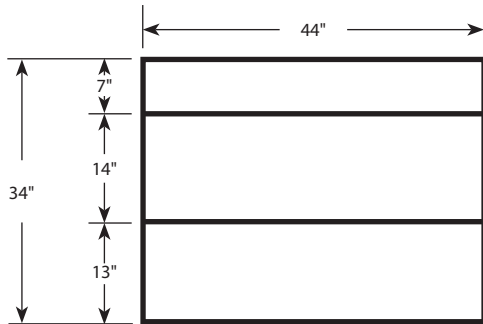

DIMENSIONS	Single Seat Modular	Single Seat Backless	18" Modular Uph. Table
Seat Depth:	17.5"	23"	-
Seat Height:	15"	15"	-
Table Height:	-	-	13"
Overall Depth:	24"	24"	24"
Overall Width:	18"	18"	18"
Overall Height:	28"	15"	14"
Qty./Wt.:	1 ea./75 lbs.	1 ea./90 lbs.	1 ea./110 lbs.



SINGLE SEAT

Laminate Top Note:

Table tops are 3/4" laminate with multi-ply edge

MODEL / DESCRIPTION / LIST PRICING

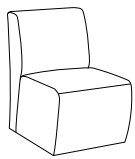

7380 Single Seat Jr. Size Modular Unit

COM Yardage: Total: 3.5 Yds. / Back: 2 Yds. / Seat: 1.5 Yds.

COM	GR1	GR2	GR3	GR4	GR5	GR6	GR7	GR8	GR9	GR10	LEA
\$1457	\$1577	\$1698	\$1839	\$1960	\$2096	\$2237	\$2374	\$2514	\$2651	\$2792	\$2991

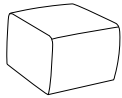

7381 Single Seat Jr. Size Backless Modular Unit

COM Yardage: Total: 2.5 Yds. / Top: 1 Yds. / Sides: 1.5 Yds.

COM	GR1	GR2	GR3	GR4	GR5	GR6	GR7	GR8	GR9	GR10	LEA
\$1363	\$1482	\$1607	\$1744	\$1863	\$2002	\$2140	\$2279	\$2418	\$2556	\$2696	\$2894

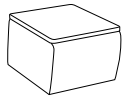

7382-T 18" x 24" Jr. Size Upholstered Modular Table with Laminate Top

COM Yardage: Total: 1.5 Yds.

COM	GR1	GR2	GR3	GR4	GR5	GR6	GR7	GR8	GR9	GR10	LEA
\$2001	\$2122	\$2240	\$2378	\$2498	\$2635	\$2774	\$2912	\$3049	\$3186	\$3324	\$3521

OPTIONS

Add upcharge to list price and code to model number

FR	CAL 133 (TB 133) Fire Retardant per yard	\$128	/yd.
MB	Moisture Barrier (1"-59"width)	\$178	ea.

GD2	Flat Ganging Device for Soft Seating	\$121	per pair
2FO	Two Fabric Option	\$141	

DIMENSIONS	30° Curve Modular	30° Curve Backless	30° Curve Uph. Table
Seat Depth:	17.5"	23"	-
Seat Height:	15"	15"	-
Table Height:	-	-	13"
Overall Depth:	24"/25"	24"/25"	24"/25"
Overall Width:	25"	25"	25"
Overall Height:	28"	15"	14"
Qty./Wt.:	1 ea./75 lbs.	1 ea./90 lbs.	1 ea./110 lbs.



30° BACKLESS UNIT



Laminate Top Note:

Table tops are 3/4" laminate with multi-ply edge

MODEL / DESCRIPTION / LIST PRICING

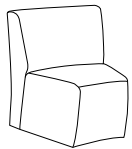

7383 30° Curve Jr. Size Modular Unit

COM Yardage: Total: 3.5 Yds. / Back: 2 Yds. / Seat: 1.5 Yds.

COM	GR1	GR2	GR3	GR4	GR5	GR6	GR7	GR8	GR9	GR10	LEA
\$2040	\$2161	\$2281	\$2419	\$2542	\$2679	\$2820	\$2957	\$3098	\$3235	\$3374	\$3572

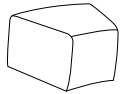

7384 30° Curve Jr. Size Backless Modular Unit

COM Yardage: Total: 2.5 Yds. / Top: 1 Yds. / Sides: 1.5 Yds.

COM	GR1	GR2	GR3	GR4	GR5	GR6	GR7	GR8	GR9	GR10	LEA
\$1904	\$2026	\$2149	\$2287	\$2407	\$2547	\$2684	\$2823	\$2961	\$3101	\$3238	\$3437

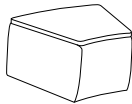

7385-T 30° Curve Jr. Size Upholstered Modular Table with Laminate Top

COM Yardage: Total: 1.5 Yds.

COM	GR1	GR2	GR3	GR4	GR5	GR6	GR7	GR8	GR9	GR10	LEA
\$2532	\$2652	\$2774	\$2912	\$3033	\$3172	\$3312	\$3451	\$3590	\$3728	\$3866	\$4064

OPTIONS

Add upcharge to list price and code to model number

FR	CAL 133 (TB 133) Fire Retardant per yard	\$128	/yd.
MB	Moisture Barrier (1"-59"width)	\$178	ea.

GD2	Flat Ganging Device for Soft Seating	\$121	per pair
2FO	Two Fabric Option	\$141	

SAMPLE CONFIGURATIONS

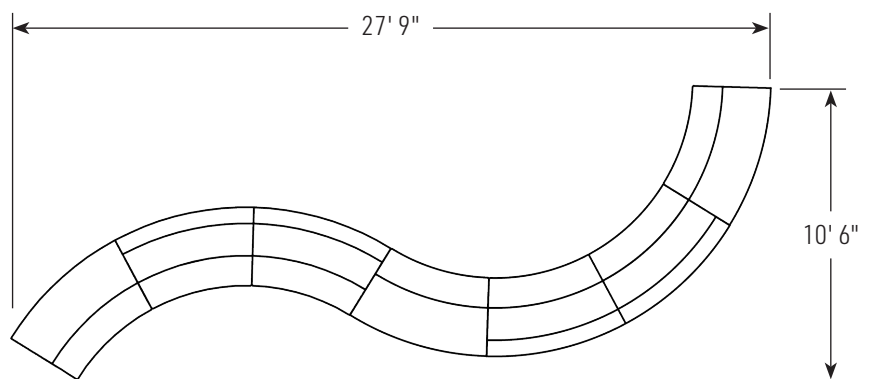
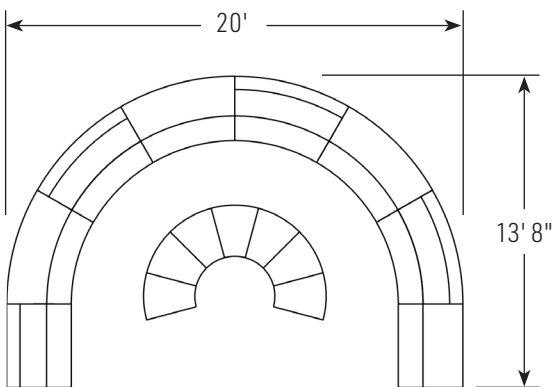
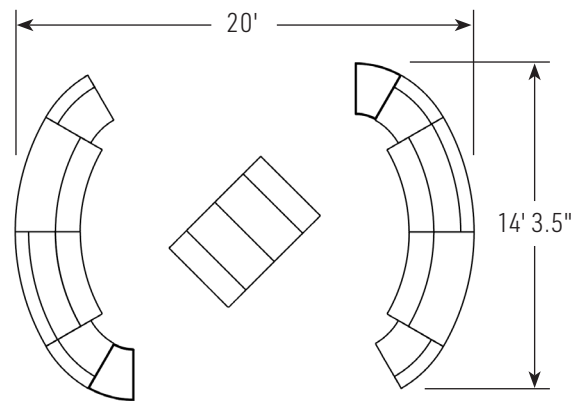
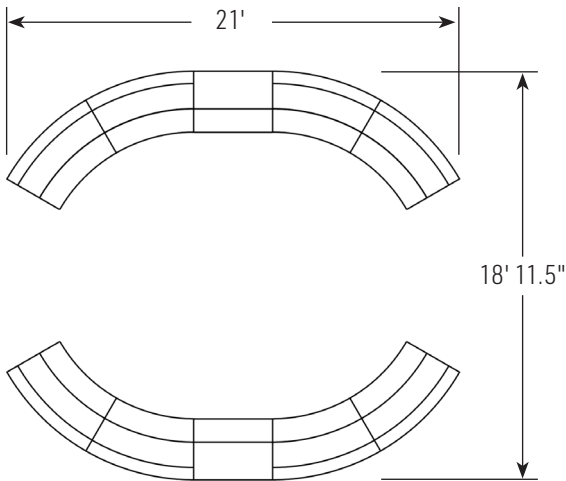
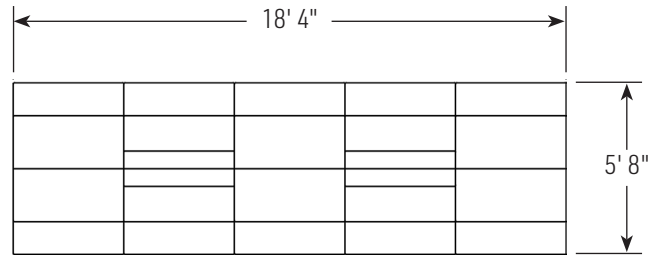
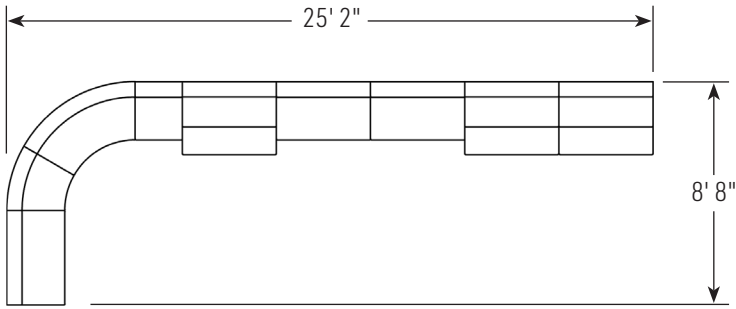

FABRIC PLACEMENT

