



COMPLEMENTED WITH TRENO TABLES

**LAGUNA TABLE OF CONTENTS**

Laguna Specifications .....	2
Laguna Standard Back vs Inset Back .....	3
Laguna Banquettes Options .....	4
Laguna Banquettes Pricing .....	5
Laguna Banquettes Privacy Panels .....	6
Laguna Modular Options .....	7
Laguna Modular Pricing .....	9
Laguna Modular Privacy Panels .....	13
Laguna Modular Arms .....	17
Laguna Modular Quattro Pricing .....	21
Laguna Lounge Options.....	22
Laguna Lounge Pricing.....	23
Laguna Lounge Hideout Pricing .....	24
Laguna Bolster & Pillows .....	26
Laguna Bench Pricing.....	27
Laguna Ottomans Pricing .....	28
Laguna Tables .....	32
Laguna Configurations .....	36

**LAGUNA**

The Laguna collection consists of variety of pieces that comprise of banquettes, modular units, lounges, benches, ottomans and tables. A very versatile lounge and modular system that will enhance any space or public environment with numerous options to customize the look. Laguna allows for private seating arrangements using our Hideout lounge or privacy panels on the modular units. Great for common areas, cafes and lobbies with an array of options and finishes for a truly American visionary design.



BANQUETTES



MODULAR



MODULAR - QUATTRO



LOUNGE - HIDEOUT



LOUNGE



BENCH



OTTOMAN



OCCASIONAL TABLE

**ORDERING INFORMATION**

- 1) Series Name
- 2) Model Number
- 3) Quantity
- 4) Fabric Grade and Number
- 5) Powder Coat Color for legs
- 6) Panel Laminate/Edge Selection
- 7) Optional Items
- 8) Optional Wood Stain Color

SOFT SEATING	WEIGHT LIMIT
1 Seat	500 lbs.
2 Seat	1000 lbs.
3 Seat	1500 lbs.

**STANDARD BASE FINISHES**

**Legs:** Standard Powder Coat

STANDARD POWDER COAT METAL LEG



**GENERAL SPECIFICATIONS**

**Frame Construction**

- Multi-ply hardwood
- Tongue and groove construction nailed and glued

**Seat/Foam**

- No-sag springs w/ helicoil attachment
- High resiliency foam construction throughout
- All foam bonded to frame

**Upholstery**

Seat and back are covered in choice of fabric, vinyl, crypton, leather or COM. ERG uses only water based glues and adhesives in our upholstery process.

**Legs**

- 8" tall, 1.5" diameter fabricated steel angeled legs
- Sand blasted prior to paint for maximum color adhesion
- Includes factory installed adjustable glides

**Note for Edge of privacy panels:**

- Straight panels: available with 3MM PVC or laminate self edge. Select from any of our 3MM PVC edges in solid or wood tone, no custom colors available.
- Curved panels: will only able available with laminate self edge.
- Both straight and curved panels: when combining straight panels and curved panels, ONLY self edge is available.

**STANDARD BACK**

**OPTIONAL INSET BACK**

BACK IS INSET 2" ON EACH SIDE



STRAIGHT UNIT

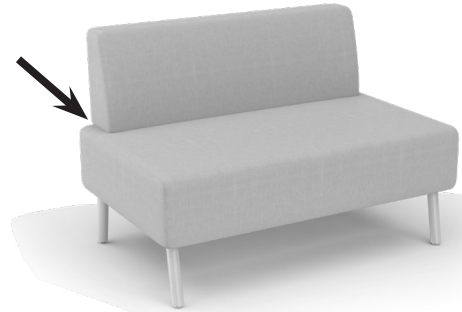

OUTSIDE CURVE



INSIDE CURVE



STRAIGHT PRIVACY  
PANEL



**OPTIONS**

- CODE: FR - CAL 133 (TB 133) Fire Retardant
- CODE: MB - Moisture Barrier (1"-59"width)
- CODE: MB60 - Moisture Barrier (60"and up)
- CODE: PC - Polished Chrome Legs
- CODE: WDL - Metal/Wood Legs. (Specify powder coat and wood color)
- CODE: WDL-C - Chrome/Wood Legs. (Specify wood color)
- CODE: 2FO - Two Fabric Option
- CODE: 3FO - Three Fabric Option
- CODE: GD1 - Ratchet Ganging Device for Soft Seating
- CODE: ISB - Inset Back

**Note:** Factory installed power/data available, see accessories online under the 'Products' tab.



SHOWN WITH 3FORM ACRYLIC PRIVACY PANEL, POWER/DATA AND METAL/WOOD LEGS

**Laguna Leg Options**



2 TONE FABRIC

OPTIONAL METAL/WOOD LEG  
CODE: WDL



OPTIONAL CHROME LEG  
CODE: PC



OPTIONAL CHROME/WOOD LEG  
CODE: WDL-C



DIMENSIONS	48" Straight	60" Straight	72" Straight	Corner Unit
Seat Depth:	21"	21"	21"	21"
Seat Width:	48"	60"	72"	21"
Seat Height:	18"	18"	18"	18"
Overall Depth:	27"	27"	27"	27"
Overall Width:	48"	60"	72"	27"
Overall Height:	30"	30"	30"	30"
Qty./Wt.:	1 ea./75 lbs.	1 ea./90 lbs.	1 ea./110 lbs.	1 ea./58 lbs.



60" W STRAIGHT UNIT

**MODEL / DESCRIPTION / LIST PRICING**



**1206** 48" W Straight (4 legs)

COM Yardage: Total: 5.25 Yds. / Back: 2.5 Yds. / Seat: 2.75 Yds.

COM	GR1	GR2	GR3	GR4	GR5	GR6	GR7	GR8	GR9	GR10	LEA
\$3298	\$3492	\$3684	\$3876	\$4066	\$4260	\$4452	\$4645	\$4838	\$5029	\$5224	\$5408



**1208** 60" W Straight (4 legs)

COM Yardage: Total: 6.5 Yds. / Back: 3 Yds. / Seat: 3.5 Yds.

COM	GR1	GR2	GR3	GR4	GR5	GR6	GR7	GR8	GR9	GR10	LEA
\$4279	\$4523	\$4712	\$4904	\$5096	\$5289	\$5481	\$5675	\$5864	\$6060	\$6253	\$6435



**1210** 72" W Straight (6 legs)

COM Yardage: Total: 7.5 Yds. / Back: 3.5 Yds. / Seat: 4 Yds.

COM	GR1	GR2	GR3	GR4	GR5	GR6	GR7	GR8	GR9	GR10	LEA
\$4790	\$5029	\$5224	\$5414	\$5607	\$5799	\$5991	\$6183	\$6377	\$6568	\$6763	\$6946



**1211** Corner Unit (4 Legs)

COM Yardage: Total: 4.25 Yds. / Back: 2 Yds. / Seat: 2.25 Yds.

COM	GR1	GR2	GR3	GR4	GR5	GR6	GR7	GR8	GR9	GR10	LEA
\$3296	\$3473	\$3636	\$3808	\$3970	\$4147	\$4322	\$4499	\$4674	\$4852	\$5025	\$5211

**Note:** For back-to-back applications please order two units.

**OPTIONS**

Add upcharge to list price and code to model number

FR	CAL 133 (TB 133) Fire Retardant per yard	\$118	/yd.
MB	Moisture Barrier (1"-59"width)	\$164	ea.
MB60	Moisture Barrier (60"and up)	\$262	ea.
WDL	Metal/Wood Legs	\$45	ea.
WDL-C	Chrome/Wood Legs	\$79	ea.

PC	Polished Chrome Legs	\$45	ea.
2FO	Two Fabric Option	\$131	
GD1	Ratchet Ganging Device for Soft Seating	\$112	per pair
ISB	Inset Back (Add to Standard Unit)	\$66	

**PRIVACY PANELS ONLY**

DIMENSIONS	48" Wide Privacy Panel	60" Wide Privacy Panel	72" Wide Privacy Panel
Panel Depth:	1"	1"	1"
Panel Width:	48"	60"	72"
Panel Height:	48"	48"	48"
Qty./Approx Wt.:	1 ea./100 lbs.	1 ea./110 lbs.	1 ea./120 lbs.



LAGUNA BANQUETTE  
WITH PRIVACY PANEL



1/2" THICK ACRYLIC  
PRIVACY PANELS AVAILABLE

**MODEL / DESCRIPTION / LIST PRICING**

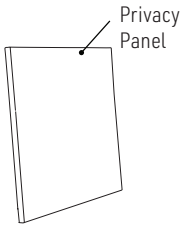

**1206P 48" W Privacy Panel**

COM Yardage: Total: 3 Yds. (Please allow extra fabric for repeat design.)

COM	GR1	GR2	GR3	GR4	GR5	GR6	GR7	GR8	GR9	GR10	LEA
\$1435	\$1536	\$1595	\$1661	\$1726	\$1796	\$1867	\$1941	\$2019	\$2100	\$2183	\$2580
LAMINATE			VENEER			ACRYLIC					
\$1405			\$2559			CALL					

**1208P 60" W Privacy Panel**

COM Yardage: Total: 4 Yds. (Please allow extra fabric for repeat design.)

COM	GR1	GR2	GR3	GR4	GR5	GR6	GR7	GR8	GR9	GR10	LEA
\$1892	\$2026	\$2104	\$2189	\$2277	\$2367	\$2459	\$2562	\$2663	\$2770	\$2881	\$3407
LAMINATE			VENEER			ACRYLIC					
\$1839			\$3291			CALL					

**1210P 72" W Privacy Panel**

COM Yardage: Total: 5 Yds. (Please allow extra fabric for repeat design.)

COM	GR1	GR2	GR3	GR4	GR5	GR6	GR7	GR8	GR9	GR10	LEA
\$2315	\$2478	\$2577	\$2682	\$2788	\$2899	\$3017	\$3137	\$3262	\$3391	\$3526	\$4170
LAMINATE			VENEER			ACRYLIC					
\$2233			\$3864			CALL					

**Note for Edge of privacy panels:**

- Straight panels: available with 3MM PVC or laminate self edge.  
Select from any of our 3MM PVC edges in solid or wood tone, no custom colors available.
- Curved panels: will only be available with laminate self edge.
- Both straight and curved panels: when combining straights and curved, ONLY self edge is available.

**OPTIONS**

- CODE: FR - CAL 133 (TB 133) Fire Retardant
- CODE: MB - Moisture Barrier (1"-59"width)
- CODE: MB60 - Moisture Barrier (60"and up)
- CODE: PC - Polished Chrome Legs
- CODE: WDL - Metal/Wood Legs. (Specify powder coat and wood color)
- CODE: WDL-C - Chrome/Wood Legs. (Specify wood color)
- CODE: CAS2 - 2" Locking Casters - Black
- CODE: AS3 - 3" Locking Casters - Black
- CODE: 2FO - Two Fabric Option
- CODE: 3FO - Three Fabric Option
- CODE: GD1 - Ratchet Ganging Device for Soft Seating
- CODE: FMG - Floor Mount Glide
- CODE: TABF-(\_) - Fixed Post Tablet  
(outside, specify (L/R), shape A, B or C)

- CODE: TABFB-(\_) - Fixed Blade Tablet  
(outside or inside, specify (L/R), shape A, B or C)
- CODE: TABR1-(\_) - Removable Tablet (shape A, B or C, left or right arm)
- CODE: TABR2-(\_) - Removable Tablet (shape A, B or C, hardware both arms)
- CODE: LAM5 - Non-standard laminate for 5 or less tablets  
see options for upcharge
- CODE: SST - Solid Surface Tablet
- CODE: SS5 - Non-standard Solid Surface top for 5 or less tablets
- CODE: BWAC - Wood Arm Cap (Box Arm)
- CODE: WAC - Wood Arm Caps
- CODE: PAC - Poly Arm Caps
- CODE: ISB - Inset Back

**Note:** Factory installed power/data available, see accessories online under the 'Products' tab.



MODULAR - QUATTRO



CURVED PRIVACY PANEL



60° BACKLESS INSIDE CURVE



30° OUTSIDE CURVE



2 TONE FABRIC

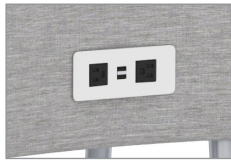

POWER/DATA

Note: Factory installed power/data available, see accessories online under the 'Products' tab.



WOOD ARM CAPS  
(BOX ARMS)



WOOD ARM CAPS  
(SLIM ARMS)

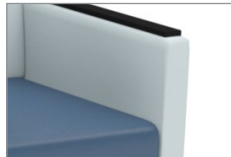

POLY ARM CAPS  
(SLIM ARMS ONLY)

**Laguna Leg Options**

OPTIONAL METAL/WOOD LEG  
CODE: WDL



OPTIONAL CHROME LEG  
CODE: PC



OPTIONAL CHROME/WOOD LEG  
CODE: WDL-C



**TABLET SHAPES**

**Three Tablet Shapes::**

Choose from the three shapes shown and specify; A, B or C and left or right (outside tablet) when ordering.  
Example: TABFB-(A) Left - this would be a fixed shape A tablet on the left side (when seated).

**Laminate Top: Tops are 3/4"**

Tablet orders of 5 or less have 4 standard laminate colors:

- Wilsonart Black 1595-60
- Wilsonart Montana Walnut 7110K-78
- Formica Brite White 459-58
- Nevamar Silver Alu Metalx MXT003

Edge: 6F Multi-Ply

**Solid Surface Top:**

Tablet orders of 5 or less have 4 standard Corian colors:  
• Bone • Canyon • Glacier White • Silver Grey

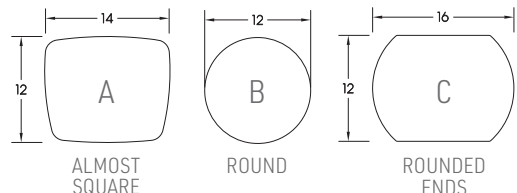

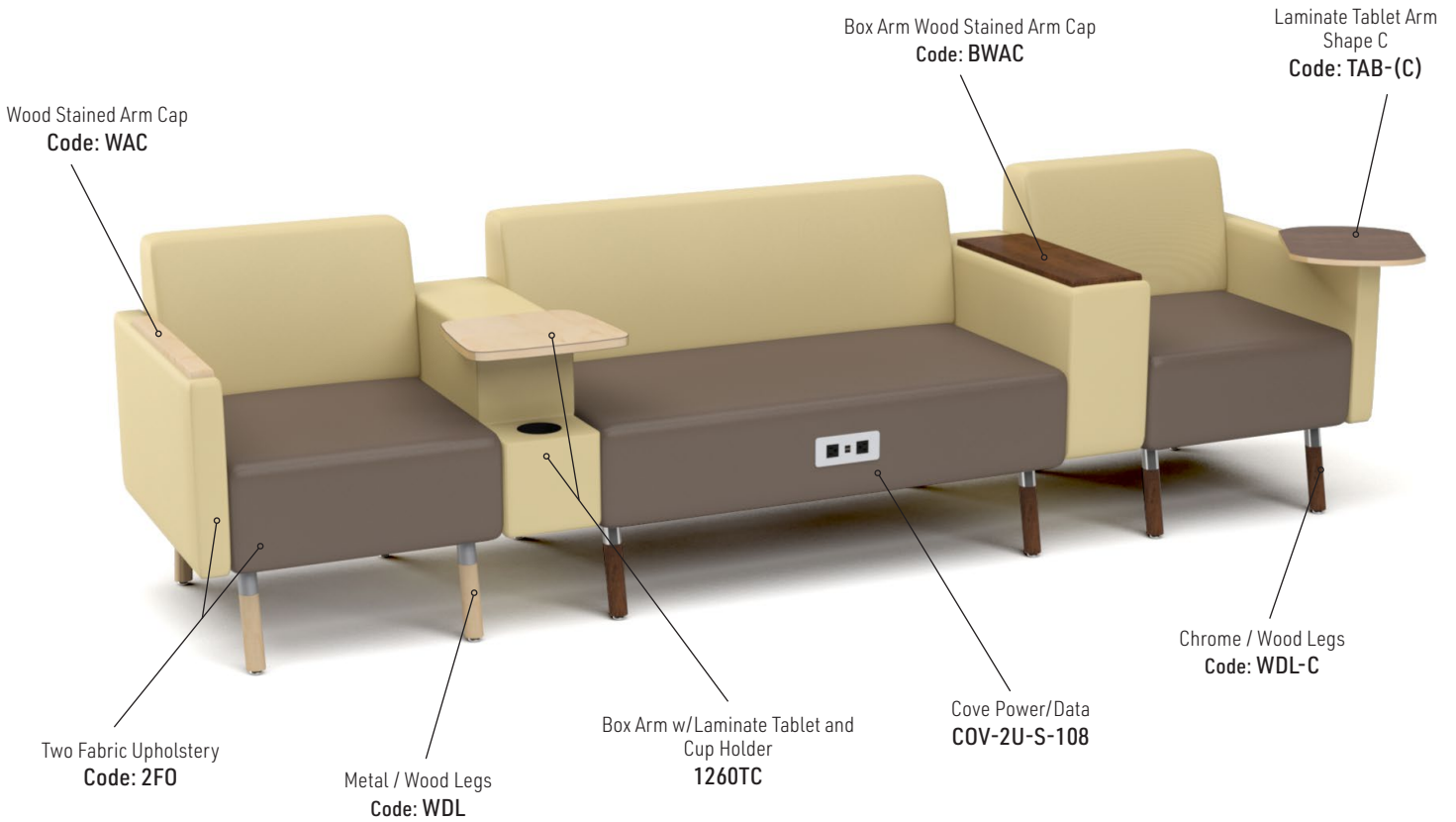
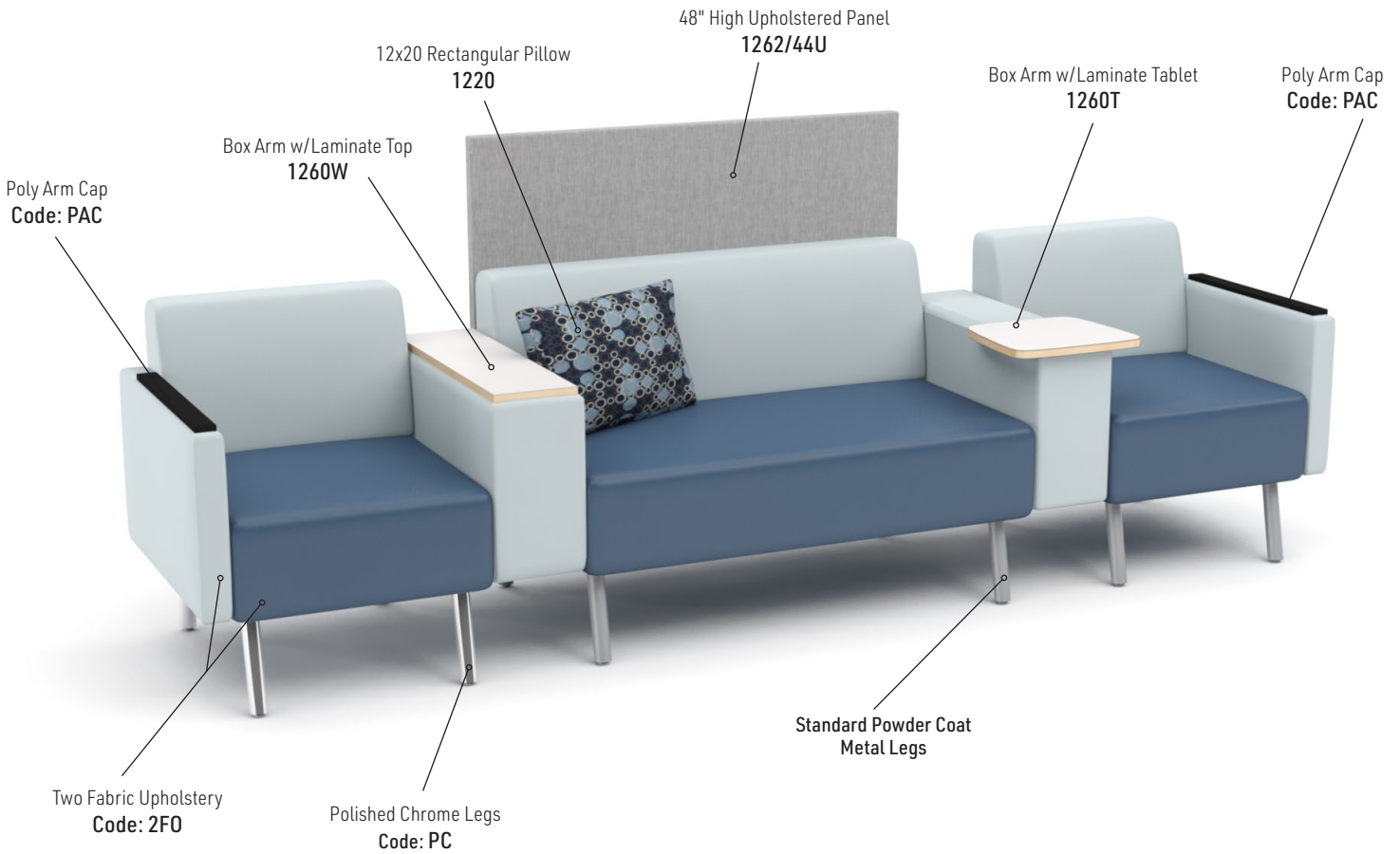



DIMENSIONS	22" Straight	30" Straight	44" Straight	Corner Unit
Seat Depth:	21"	21"	21"	21"
Seat Width:	22"	30"	44"	21"
Seat Height:	18"	18"	18"	18"
Overall Depth:	27"	27"	27"	27"
Overall Width:	22"	30"	44"	27"
Overall Height:	30"	30"	30"	30"
Qty./Wt.:	1 ea./58 lbs.	1 ea./68 lbs.	1 ea./85 lbs.	1 ea./58 lbs.



STRAIGHT UNIT WITH OPTIONAL METAL/WOOD LEGS



CORNER UNIT WITH OPTIONAL METAL/WOOD LEGS

**MODEL / DESCRIPTION / LIST PRICING**



**1200** 22" W Straight Units (4 Legs)

COM Yardage: Total: 3 Yds. / Back: 1.5 Yds. / Seat: 1.5 Yds.

COM	GR1	GR2	GR3	GR4	GR5	GR6	GR7	GR8	GR9	GR10	LEA
\$1963	\$2073	\$2187	\$2315	\$2428	\$2555	\$2684	\$2812	\$2940	\$3068	\$3197	\$3381



**1202** 30" W Straight Units (4 Legs)

COM Yardage: Total: 4 Yds. / Back: 1.75 Yds. / Seat: 2.25 Yds.

COM	GR1	GR2	GR3	GR4	GR5	GR6	GR7	GR8	GR9	GR10	LEA
\$2286	\$2422	\$2565	\$2727	\$2872	\$3032	\$3192	\$3352	\$3512	\$3671	\$3866	\$4048



**1204** 44" W Straight Units (4 Legs)

COM Yardage: Total: 4.5 Yds. / Back: 2 Yds. / Seat: 2.5 Yds.

COM	GR1	GR2	GR3	GR4	GR5	GR6	GR7	GR8	GR9	GR10	LEA
\$3203	\$3394	\$3587	\$3780	\$3972	\$4166	\$4358	\$4550	\$4742	\$4933	\$5126	\$5313



**1218** Corner Unit (4 Legs)

COM Yardage: Total: 4.25 Yds. / Back: 2 Yds. / Seat: 2.25 Yds.

COM	GR1	GR2	GR3	GR4	GR5	GR6	GR7	GR8	GR9	GR10	LEA
\$3296	\$3473	\$3636	\$3808	\$3970	\$4147	\$4322	\$4499	\$4674	\$4852	\$5025	\$5211

**OPTIONS**

Add upcharge to list price and code to model number

FR	CAL 133 (TB 133) Fire Retardant per yard	\$118	/yd.	GD1	Ratchet Ganging Device for Soft Seating	\$112	per pair
MB	Moisture Barrier (1"-59"width)	\$164	ea.	TABFB-( )	Fixed Blade Tablet (outside or inside, specify (L/R), shape A, B or C)	\$593	ea. tablet
WDL	Metal/Wood Legs	\$45	ea.	LAM5	Non-standard laminate (5 tablets or less)	\$554	ea. tablet
WDL-C	Chrome/Wood Legs	\$79	ea.	SST	Solid Surface Tablet Arm - add to tablet option	\$271	ea. tablet
PC	Polished Chrome Legs	\$45	ea.	SS5	Non-standard Solid Surface (5 tablets or less)	Call For Quote	
2FO	Two Fabric Option	\$131		ISB	Inset Back (Add to Standard Unit)	\$66	

DIMENSIONS	30° Inside Curve	30° Outside Curve
Seat Depth:	21"	21"
Seat Width:	17"	31"
Seat Height:	18"	18"
Overall Depth:	27"/28"	27"/28"
Overall Width:	17"/31"	17"/31"
Overall Height:	30"	30"
Qty./Wt.:	1 ea./58 lbs.	1 ea./68 lbs.



INSIDE CURVE UNIT WITH  
OPTIONAL METAL/WOOD LEGS

**MODEL / DESCRIPTION / LIST PRICING**



**1212** Inside 30° Curve Unit (4 Legs)

COM Yardage: Total: 4 Yds. / Back: 2 Yds. / Seat: 2 Yds.

COM	GR1	GR2	GR3	GR4	GR5	GR6	GR7	GR8	GR9	GR10	LEA
\$1973	\$2080	\$2186	\$2306	\$2414	\$2534	\$2654	\$2774	\$2895	\$3019	\$3139	\$3311



**1213** Outside 30° Curve Unit (4 Legs)

COM Yardage: Total: 3.5 Yds. / Back: 1.5 Yds. / Seat: 2 Yds.

COM	GR1	GR2	GR3	GR4	GR5	GR6	GR7	GR8	GR9	GR10	LEA
\$2086	\$2208	\$2314	\$2435	\$2542	\$2661	\$2783	\$2903	\$3024	\$3144	\$3267	\$3441

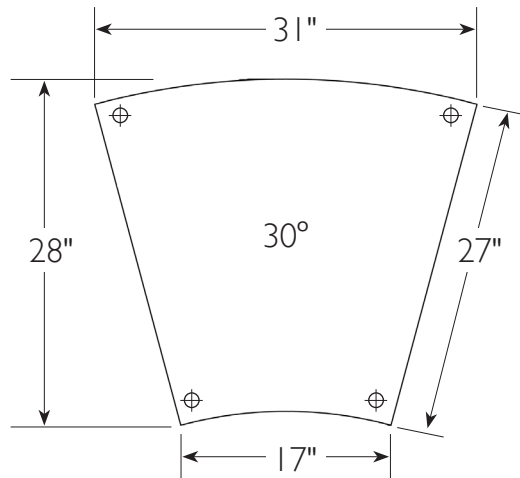

**OPTIONS**

Add upcharge to list price and code to model number

FR	CAL 133 (TB 133) Fire Retardant per yard	\$118	/yd.
MB	Moisture Barrier (1"-59"width)	\$164	ea.
WDL	Metal/Wood Legs	\$45	ea.
WDL-C	Chrome/Wood Legs	\$79	ea.
PC	Polished Chrome Legs	\$45	ea.
2FO	Two Fabric Option	\$131	

GD1	Ratchet Ganging Device for Soft Seating	\$112	per pair
TABFB- ( )	Fixed Blade Tablet (outside or inside, specify (L/R), shape A, B or C)	\$593	ea. tablet
LAM5	Non-standard laminate (5 tablets or less)	\$554	ea. tablet
SST	Solid Surface Tablet Arm - add to tablet option	\$271	ea. tablet
SS5	Non-standard Solid Surface (5 tablets or less)	Call For Quote	
ISB	Inset Back (Add to Standard Unit)	\$66	

DIMENSIONS	45° Inside Curve	45° Outside Curve
Seat Depth:	21"	21"
Seat Width:	25"	46"
Seat Height:	18"	18"
Overall Depth:	27"/29.5"	27"/29.5"
Overall Width:	25.25"/46"	25.25"/46"
Overall Height:	30"	30"
Qty./Wt.:	1 ea./58 lbs.	1 ea./68 lbs.



INSIDE CURVE UNIT WITH  
OPTIONAL METAL/WOOD LEGS

**MODEL / DESCRIPTION / LIST PRICING**



**1214** Inside 45° Curve (4 Legs)

COM Yardage: Total: 5.5 Yds. / Back: 2.5 Yds. / Seat: 3 Yds.

COM	GR1	GR2	GR3	GR4	GR5	GR6	GR7	GR8	GR9	GR10	LEA
\$3096	\$3260	\$3417	\$3594	\$3756	\$3930	\$4108	\$4282	\$4459	\$4635	\$4811	\$4997



**1215** Outside 45° Curve (4 Legs)

COM Yardage: Total: 5.25 Yds. / Back: 2.25 Yds. / Seat: 3 Yds.

COM	GR1	GR2	GR3	GR4	GR5	GR6	GR7	GR8	GR9	GR10	LEA
\$3453	\$3615	\$3776	\$3952	\$4111	\$4290	\$4466	\$4642	\$4816	\$4994	\$5170	\$5354

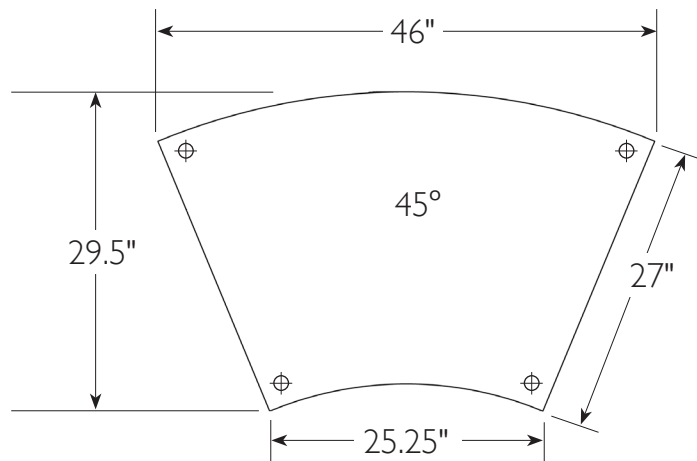

**OPTIONS**

Add upcharge to list price and code to model number

FR	CAL 133 (TB 133) Fire Retardant per yard	\$118	/yd.
MB	Moisture Barrier (1"-59"width)	\$164	ea.
WDL	Metal/Wood Legs	\$45	ea.
WDL-C	Chrome/Wood Legs	\$79	ea.
PC	Polished Chrome Legs	\$45	ea.
2FO	Two Fabric Option	\$131	

GD1	Ratchet Ganging Device for Soft Seating	\$112	per pair
TABFB-(L)	Fixed Blade Tablet (outside or inside, specify (L/R), shape A, B or C)	\$593	ea. tablet
LAM5	Non-standard laminate (5 tablets or less)	\$554	ea. tablet
SST	Solid Surface Tablet Arm - add to tablet option	\$271	ea. tablet
SS5	Non-standard Solid Surface (5 tablets or less)	Call For Quote	
ISB	Inset Back (Add to Standard Unit)	\$66	

DIMENSIONS	60° Inside Curve	60° Outside Curve
Seat Depth:	21"	21"
Seat Width:	33"	60"
Seat Height:	18"	18"
Overall Depth:	27"/31.5"	27"/31.5"
Overall Width:	33"/60"	33"/60"
Overall Height:	30"	30"
Qty./Wt.:	1 ea./58 lbs.	1 ea./68 lbs.



INSIDE CURVE UNIT WITH  
OPTIONAL METAL/WOOD LEGS

**MODEL / DESCRIPTION / LIST PRICING**



**1216** Inside 60° Curve (5 legs)

COM Yardage: Total: 7 Yds. / Back: 3 Yds. / Seat: 4 Yds.

COM	GR1	GR2	GR3	GR4	GR5	GR6	GR7	GR8	GR9	GR10	LEA
\$3300	\$3463	\$3621	\$3798	\$3960	\$4135	\$4312	\$4488	\$4666	\$4840	\$5019	\$5202

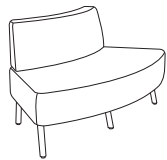

**1217** Outside 60° Curve (5 legs)

COM Yardage: Total: 6.5 Yds. / Back: 2.5 Yds. / Seat: 4 Yds.

COM	GR1	GR2	GR3	GR4	GR5	GR6	GR7	GR8	GR9	GR10	LEA
\$3485	\$3663	\$3823	\$3997	\$4156	\$4333	\$4508	\$4686	\$4862	\$5039	\$5214	\$5401

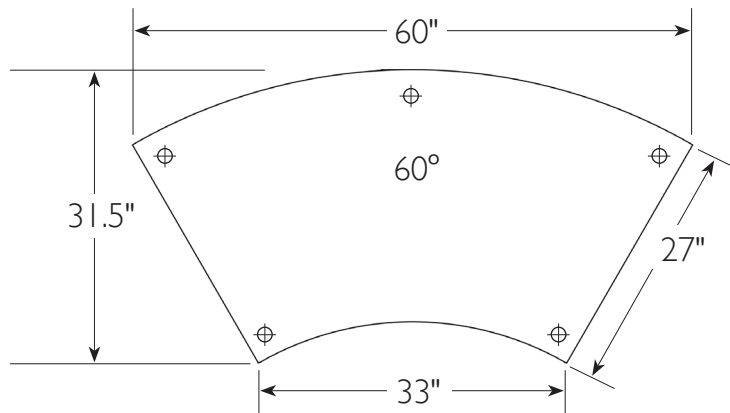

**OPTIONS**

Add upcharge to list price and code to model number

FR	CAL 133 (TB 133) Fire Retardant per yard	\$118	/yd.	GD1	Ratchet Ganging Device for Soft Seating	\$112	per pair
MB	Moisture Barrier (1"-59"width)	\$164	ea.	TABFB-(L)	Fixed Blade Tablet (outside or inside, specify (L/R), shape A, B or C)	\$593	ea. tablet
WDL	Metal/Wood Legs	\$45	ea.	LAM5	Non-standard laminate (5 tablets or less)	\$554	ea. tablet
WDL-C	Chrome/Wood Legs	\$79	ea.	SST	Solid Surface Tablet Arm - add to tablet option	\$271	ea. tablet
PC	Polished Chrome Legs	\$45	ea.	SS5	Non-standard Solid Surface (5 tablets or less)	Call For Quote	
2FO	Two Fabric Option	\$131		ISB	Inset Back (Add to Standard Unit)	\$66	

DIMENSIONS	Straight Panel	Straight Panel	Straight Panel
Panel Depth:	1"	1"	1"
Overall Width:	22"	30"	44"
Overall Height:	48"	48"	48"
Qty./Approx Wt.:	1 ea./100 lbs.	1 ea./110 lbs.	1 ea./120 lbs.

**Note:** For Laminate or Acrylic, please call for quote.



STRAIGHT PRIVACY PANEL

**MODEL / DESCRIPTION / LIST PRICING**

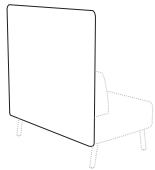

**1262/22U** 22" Straight Panel - Upholstered

COM Yardage - Panel: 1.5 Yds.

COM	GR1	GR2	GR3	GR4	GR5	GR6	GR7	GR8	GR9	GR10	LEA
\$941	\$1007	\$1050	\$1093	\$1135	\$1180	\$1229	\$1275	\$1326	\$1379	\$1436	\$1699

**1262/30U** 30" Straight Panel - Upholstered

COM Yardage - Panel: 2 Yds.

COM	GR1	GR2	GR3	GR4	GR5	GR6	GR7	GR8	GR9	GR10	LEA
\$1169	\$1250	\$1300	\$1348	\$1408	\$1460	\$1520	\$1582	\$1643	\$1708	\$1778	\$2100

**1262/44U** 44" Straight Panel - Upholstered

COM Yardage - Panel: 2.5 Yds.

COM	GR1	GR2	GR3	GR4	GR5	GR6	GR7	GR8	GR9	GR10	LEA
\$1342	\$1436	\$1491	\$1554	\$1613	\$1680	\$1747	\$1817	\$1890	\$1965	\$2045	\$2415

**OPTIONS**

Add upcharge to list price and code to model number

FR	CAL 133 (TB 133) Fire Retardant per yard	\$118	/yd.	2FO	Two Fabric Option	\$131	
----	--	-------	------	-----	-------------------	-------	--

DIMENSIONS	Inset Straight Panel	Inset Straight Panel	Inset Straight Panel
Panel Depth:	1"	1"	1"
Overall Width:	18"	26"	40"
Overall Height:	48"	48"	48"
Qty./Approx Wt.:	1 ea./100 lbs.	1 ea./110 lbs.	1 ea./120 lbs.

**Note:** Upholstered panels are 1.0" thick.  
For Laminate or Acrylic, please call for quote.



INSET STRAIGHT PRIVACY PANEL

**MODEL / DESCRIPTION / LIST PRICING**

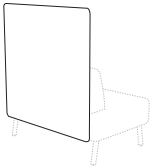

**1263/18U** Inset 18" Inset Straight Panel - Upholstered

COM Yardage - Panel: 1.5 Yds.

COM	GR1	GR2	GR3	GR4	GR5	GR6	GR7	GR8	GR9	GR10	LEA
\$1028	\$1093	\$1132	\$1176	\$1218	\$1264	\$1311	\$1360	\$1410	\$1462	\$1519	\$1780

**1263/26U** Inset 26" Inset Straight Panel - Upholstered

COM Yardage - Panel: 2 Yds.

COM	GR1	GR2	GR3	GR4	GR5	GR6	GR7	GR8	GR9	GR10	LEA
\$1250	\$1332	\$1383	\$1432	\$1489	\$1541	\$1602	\$1664	\$1726	\$1791	\$1861	\$2183

**1263/40U** Inset 40" Inset Straight Panel - Upholstered

COM Yardage - Panel: 2.5 Yds.

COM	GR1	GR2	GR3	GR4	GR5	GR6	GR7	GR8	GR9	GR10	LEA
\$1425	\$1519	\$1575	\$1635	\$1697	\$1762	\$1827	\$1901	\$1973	\$2048	\$2127	\$2496

**OPTIONS**

Add upcharge to list price and code to model number

FR	CAL 133 (TB 133) Fire Retardant per yard	\$118	/yd.	2FO	Two Fabric Option	\$131	
----	--	-------	------	-----	-------------------	-------	--

DIMENSIONS	Inside Curve Panel	Inside Curve Panel	Inside Curve Panel
Panel Depth:	1"	1"	1"
Overall Width:	31"	46"	60"
Overall Height:	48"	48"	48"
Qty./Approx Wt.:	1 ea./100 lbs.	1 ea./110 lbs.	1 ea./120 lbs.

DIMENSIONS	Outside Curve Panel	Outside Curve Panel	Outside Curve Panel
Panel Depth:	1"	1"	1"
Overall Width:	17"	25"	33"
Overall Height:	48"	48"	48"
Qty./Approx Wt.:	1 ea./100 lbs.	1 ea./110 lbs.	1 ea./120 lbs.



45° INSIDE CURVE PRIVACY PANEL

45° OUTSIDE CURVE PANEL

**Note:** Upholstered panels are 1.0" thick.  
For Laminate or Acrylic, please call for quote.

### MODEL / DESCRIPTION / LIST PRICING

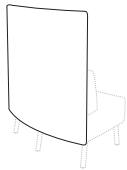

#### 1270/30U 30° Inside Curve Panel - Upholstered

COM Yardage - Panel: 2 Yds.

COM	GR1	GR2	GR3	GR4	GR5	GR6	GR7	GR8	GR9	GR10	LEA
\$1752	\$1871	\$1944	\$2026	\$2107	\$2190	\$2278	\$2368	\$2466	\$2562	\$2664	\$3151

#### 1270/45U 45° Inside Curve Panel - Upholstered

COM Yardage - Panel: 3 Yds.

COM	GR1	GR2	GR3	GR4	GR5	GR6	GR7	GR8	GR9	GR10	LEA
\$2015	\$2156	\$2239	\$2328	\$2423	\$2521	\$2622	\$2726	\$2834	\$2948	\$3062	\$3623

#### 1270/60U 60° Inside Curve Panel - Upholstered

COM Yardage - Panel: 4 Yds.

COM	GR1	GR2	GR3	GR4	GR5	GR6	GR7	GR8	GR9	GR10	LEA
\$3143	\$3362	\$3498	\$3639	\$3781	\$3934	\$4089	\$4256	\$4423	\$4604	\$4786	\$5658

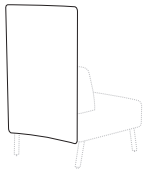

#### 1272/30U 30° Outside Curve Panel - Upholstered

COM Yardage - Panel: 2 Yds.

COM	GR1	GR2	GR3	GR4	GR5	GR6	GR7	GR8	GR9	GR10	LEA
\$1489	\$1591	\$1655	\$1721	\$1790	\$1863	\$1938	\$2015	\$2095	\$2177	\$2265	\$2680

#### 1272/45U 45° Outside Curve Panel - Upholstered

COM Yardage - Panel: 3 Yds.

COM	GR1	GR2	GR3	GR4	GR5	GR6	GR7	GR8	GR9	GR10	LEA
\$1712	\$1832	\$1905	\$1978	\$2063	\$2140	\$2230	\$2315	\$2406	\$2506	\$2601	\$3078

#### 1272/60U 60° Outside Curve Panel - Upholstered

COM Yardage - Panel: 4 Yds.

COM	GR1	GR2	GR3	GR4	GR5	GR6	GR7	GR8	GR9	GR10	LEA
\$2670	\$2857	\$2973	\$3093	\$3216	\$3342	\$3479	\$3619	\$3761	\$3909	\$4071	\$4807

### OPTIONS

Add upcharge to list price and code to model number

FR	CAL 133 (TB 133) Fire Retardant per yard	\$118	/yd.	2FO	Two Fabric Option	\$131	
----	--	-------	------	-----	-------------------	-------	--

DIMENSIONS	Inset Inside Curve Panel	Inset Inside Curve Panel	Inset Inside Curve Panel
Panel Depth:	1"	1"	1"
Overall Width:	27"	42"	56"
Overall Height:	48"	48"	48"
Qty./Wt.:	1 ea./100 lbs.	1 ea./110 lbs.	1 ea./120 lbs.

DIMENSIONS	Inset Outside Curve Panel	Inset Outside Curve Panel	Inset Outside Curve Panel
Panel Depth:	1"	1"	1"
Overall Width:	13"	21"	29"
Overall Height:	48"	48"	48"
Qty./Wt.:	1 ea./100 lbs.	1 ea./110 lbs.	1 ea./120 lbs.

**Note:** Upholstered panels are 1.0" thick.  
For Laminate or Acrylic, please call for quote.



INSET INSIDE CURVE PRIVACY PANEL



INSET OUTSIDE CURVE PRIVACY PANEL

**MODEL / DESCRIPTION / LIST PRICING**

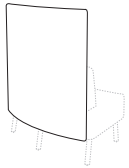

**1271/30U** Inset 30° Inside Curve Panel - Upholstered

COM Yardage - Panel: 2 Yds.

COM	GR1	GR2	GR3	GR4	GR5	GR6	GR7	GR8	GR9	GR10	LEA
\$1833	\$1955	\$2028	\$2108	\$2186	\$2274	\$2361	\$2452	\$2548	\$2642	\$2748	\$3233

**1271/45U** Inset 45° Inside Curve Panel - Upholstered

COM Yardage - Panel: 3 Yds.

COM	GR1	GR2	GR3	GR4	GR5	GR6	GR7	GR8	GR9	GR10	LEA
\$2095	\$2237	\$2324	\$2412	\$2506	\$2600	\$2705	\$2809	\$2913	\$3029	\$3147	\$3704

**1271/60U** Inset 60° Inside Curve Panel - Upholstered

COM Yardage - Panel: 4 Yds.

COM	GR1	GR2	GR3	GR4	GR5	GR6	GR7	GR8	GR9	GR10	LEA
\$3225	\$3444	\$3578	\$3721	\$3866	\$4015	\$4173	\$4339	\$4506	\$4684	\$4869	\$5740

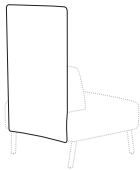

**1273/30U** Inset 30° Outside Curve Panel - Upholstered

COM Yardage - Panel: 2 Yds.

COM	GR1	GR2	GR3	GR4	GR5	GR6	GR7	GR8	GR9	GR10	LEA
\$1572	\$1672	\$1734	\$1804	\$1871	\$1944	\$2020	\$2095	\$2178	\$2259	\$2349	\$2761

**1273/45U** Inset 45° Outside Curve Panel - Upholstered

COM Yardage - Panel: 3 Yds.

COM	GR1	GR2	GR3	GR4	GR5	GR6	GR7	GR8	GR9	GR10	LEA
\$1795	\$1913	\$1988	\$2063	\$2141	\$2226	\$2311	\$2398	\$2490	\$2589	\$2687	\$3163

**1273/60U** Inset 60° Outside Curve Panel - Upholstered

COM Yardage - Panel: 4 Yds.

COM	GR1	GR2	GR3	GR4	GR5	GR6	GR7	GR8	GR9	GR10	LEA
\$2754	\$2939	\$3055	\$3175	\$3298	\$3426	\$3559	\$3700	\$3844	\$3993	\$4153	\$4891

**OPTIONS**

Add upcharge to list price and code to model number

FR	CAL 133 (TB 133) Fire Retardant per yard	\$118	/yd.
----	--	-------	------

2FO	Two Fabric Option	\$131	
-----	-------------------	-------	--



DIMENSIONS	Outside Slim Arm L/R	Center Slim Arm
Overall Depth:	27"	20"
Overall Width:	2.5"	2.5"
Arm Height:	24"	7"
Qty./Wt.:	1 ea./25 lbs.	1 ea./10 lbs.



**MODEL / DESCRIPTION / LIST PRICING**

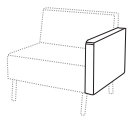

**1259L** Left Outside Slim Arm

COM Yardage: Total: 1.5 Yds.

COM	GR1	GR2	GR3	GR4	GR5	GR6	GR7	GR8	GR9	GR10	LEA
\$436	\$467	\$487	\$505	\$525	\$545	\$568	\$590	\$612	\$639	\$664	\$784

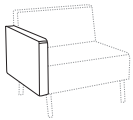

**1259R** Right Outside Slim Arm

COM Yardage: Total: 1.5 Yds.

COM	GR1	GR2	GR3	GR4	GR5	GR6	GR7	GR8	GR9	GR10	LEA
\$436	\$467	\$487	\$505	\$525	\$545	\$568	\$590	\$612	\$639	\$664	\$784

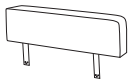

**1259C** Center Slim Arm

COM Yardage: Total: 1 Yds.

COM	GR1	GR2	GR3	GR4	GR5	GR6	GR7	GR8	GR9	GR10	LEA
\$400	\$472	\$529	\$602	\$656	\$711	\$766	\$819	\$896	\$968	\$1041	\$1205

**TABLET SHAPES**

**Three Tablet Shapes::**

Choose from the three shapes shown and specify; A, B or C and left or right (outside tablet) when ordering.

Example: TABF-(A) Left - this would be a fixed shape A tablet on the left side (when seated).

**Laminate Top: Tops are 3/4"**

Tablet orders of 5 or less have 4 standard laminate colors:

- Wilsonart Black 1595-60
- Wilsonart Montana Walnut 7110K-78
- Formica Brite White 459-58
- Nevamar Silver Alu Metalx MXT003

Edge: 6F Multi-Ply

**Solid Surface Top:**

Tablet orders of 5 or less have 4 standard Corian colors:

- Bone
- Canyon
- Glacier White
- Silver Grey

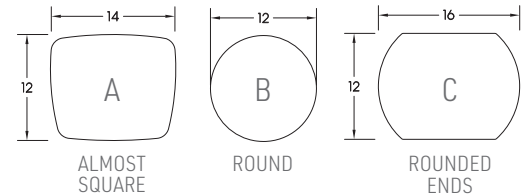

**OPTIONS**

Add upcharge to list price and code to model number

FR	CAL 133 (TB 133) Fire Retardant per yard	\$118	/yd.	TABR2-( )	Removable Tablet (specify A, B or C both arm openings)	\$893	ea. tablet
WAC	Wood Arm Cap (Slim Arm)	\$116	each	LAM5	Non-standard laminate (5 tablets or less)	\$554	ea. tablet
PAC	Poly Arm Cap - Standard Black/Charcoal (Slim Arm)	\$89	each	SST	Solid Surface Tablet Arm - add to tablet option	\$271	ea. tablet
TAB-( )	Swivel Tablet (specify A, B or C, left or right arm)	\$653	ea. tablet	SS5	Non-standard Solid Surface (5 tablets or less)	Call For Quote	
TABR1-( )	Removable Tablet (specify A, B or C, left or right arm)	\$756	ea. tablet				

DIMENSIONS	Center Box Arm
Overall Depth:	27"
Overall Width:	8"
Arm Height:	24"
Qty./Wt.:	1 ea./25 lbs.

**Note:** Box arms are only available as center arms



CENTER BOX ARMS

**MODEL / DESCRIPTION / LIST PRICING**

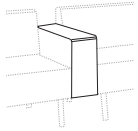

**1260C** Box Arm

COM Yardage: Total: 2 Yds

COM	GR1	GR2	GR3	GR4	GR5	GR6	GR7	GR8	GR9	GR10	LEA
\$532	\$605	\$660	\$734	\$790	\$844	\$899	\$953	\$1025	\$1099	\$1172	\$1338

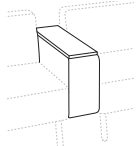

**1260W** Box Arm plus Table

COM Yardage: Total: 2 Yds

COM	GR1	GR2	GR3	GR4	GR5	GR6	GR7	GR8	GR9	GR10	LEA
\$1108	\$1180	\$1237	\$1309	\$1365	\$1418	\$1473	\$1530	\$1604	\$1676	\$1751	\$1914

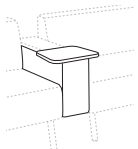

**1260T** Box Arm plus Fixed Tablet

COM Yardage: Total: 2 Yds

COM	GR1	GR2	GR3	GR4	GR5	GR6	GR7	GR8	GR9	GR10	LEA
\$1043	\$1116	\$1172	\$1246	\$1302	\$1357	\$1410	\$1466	\$1540	\$1611	\$1684	\$1850

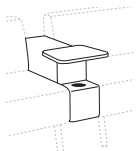

**1260TC** Box Arm plus Fixed Tablet plus Cup Holder

COM Yardage: Total: 2 Yds

COM	GR1	GR2	GR3	GR4	GR5	GR6	GR7	GR8	GR9	GR10	LEA
\$1483	\$1557	\$1611	\$1684	\$1742	\$1795	\$1850	\$1906	\$1978	\$2053	\$2125	\$2292

**Notes:**

•Box arm pricing includes ganging

**Laminate Top: Tops are 3/4"**

Tablet orders of 5 or less have 4 standard laminate colors:

- Wilsonart Black 1595-60
- Wilsonart Montana Walnut 7110K-78
- Formica Brite White 459-58
- Nevamar Silver Alu Metalx MXT003

Edge: 6F Multi-Ply

**Solid Surface Top:**

Tablet orders of 5 or less have 4 standard Corian colors:

- Bone
- Canyon
- Glacier White
- Silver Grey

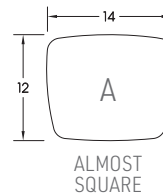

Box Arm Cap tablet available in Shape A only and is fixed

**OPTIONS**

Add upcharge to list price and code to model number

FR	CAL 133 (TB 133) Fire Retardant per yard	\$118	/yd.	LAM5	Non-standard laminate (5 tablets or less)	\$554	ea. tablet
BWAC	Wood Arm Cap (Box Arm)	\$307	ea.	SST	Solid Surface Tablet Arm - add to tablet option	\$271	ea. tablet
				SS5	Non-standard Solid Surface (5 tablets or less)		Call For Quote

DIMENSIONS	22" Straight	30" Straight	44" Straight
Seat Height:	18"	18"	18"
Overall Depth:	27"	27"	27"
Overall Width:	22"	30"	44"
Qty./Wt.:	1 ea./58 lbs.	1 ea./68 lbs.	1 ea./85 lbs.



44" BACKLESS STRAIGHT UNIT COMPLEMENTED WITH TRENO AND DIXON OCCASIONAL TABLES

**MODEL / DESCRIPTION / LIST PRICING**



**1226** 22" W Backless Straight (4 Legs)

COM Yardage: Total: 2 Yds. / Sides: 1 Yds. / Top Front Rear 1 Yds.

COM	GR1	GR2	GR3	GR4	GR5	GR6	GR7	GR8	GR9	GR10	LEA
\$1717	\$1832	\$1942	\$2070	\$2185	\$2313	\$2440	\$2567	\$2697	\$2825	\$2951	\$3137



**1228** 30" W Backless Straight (4 Legs)

COM Yardage: Total: 2.75 Yds. / Sides: 1 Yds. / Top Front Rear 1.75 Yds.

COM	GR1	GR2	GR3	GR4	GR5	GR6	GR7	GR8	GR9	GR10	LEA
\$2035	\$2229	\$2421	\$2614	\$2807	\$2997	\$3190	\$3384	\$3575	\$3768	\$3960	\$4146



**1230** 44" W Backless Straight (4 Legs)

COM Yardage: Total: 3 Yds. / Sides: 1 Yds. / Top Front Rear 2 Yds.

COM	GR1	GR2	GR3	GR4	GR5	GR6	GR7	GR8	GR9	GR10	LEA
\$2976	\$3169	\$3361	\$3554	\$3744	\$3938	\$4130	\$4323	\$4518	\$4707	\$4900	\$5084

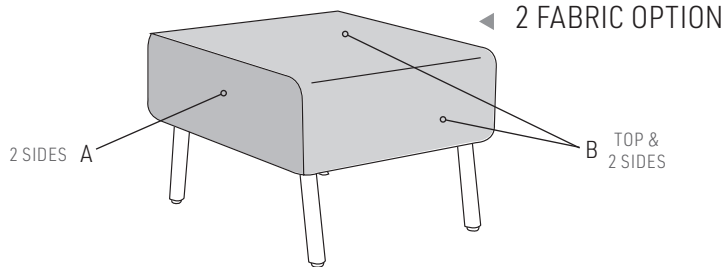

**OPTIONS**

Add upcharge to list price and code to model number

FR	CAL 133 (TB 133) Fire Retardant per yard	\$118	/yd.	GD1	Ratchet Ganging Device for Soft Seating	\$112	per pair
MB	Moisture Barrier (1"-59"width)	\$164	ea.	TABFB- ( )	Fixed Blade Tablet (outside or inside, specify (L/R), shape A, B or C)	\$593	ea. tablet
WDL	Metal/Wood Legs	\$45	ea.	LAM5	Non-standard laminate (5 tablets or less)	\$554	ea. tablet
WDL-C	Chrome/Wood Legs	\$79	ea.	SST	Solid Surface Tablet Arm - add to tablet option	\$271	ea. tablet
PC	Polished Chrome Legs	\$45	ea.	SS5	Non-standard Solid Surface (5 tablets or less)	Call For Quote	
2FO	Two Fabric Option	\$131					

DIMENSIONS	30° Curve	45° Curve	60° Curve
Seat Height:	18"	18"	18"
Overall Depth:	27"/28"	27"/29.5"	27"/31.5"
Overall Width:	17"/31"	25.25"/46"	33"/60"
Qty./Wt.:	1 ea./58 lbs.	1 ea./68 lbs.	1 ea./85 lbs.



30° BACKLESS CURVE UNIT

**MODEL / DESCRIPTION / LIST PRICING**



**1232** 30° Backless Curve (4 Legs)

COM Yardage: Total: 2.25 Yds. / Sdies: 1 Yds. / Top-Front-Rear: 1.25 Yds

COM	GR1	GR2	GR3	GR4	GR5	GR6	GR7	GR8	GR9	GR10	LEA
\$1802	\$1913	\$2028	\$2155	\$2265	\$2393	\$2523	\$2651	\$2780	\$2909	\$3035	\$3221



**1234** 45° Backless Curve (4 Legs)

COM Yardage: Total: 3 Yds. / Sdies: 1 Yds. / Top-Front-Rear: 2 Yds

COM	GR1	GR2	GR3	GR4	GR5	GR6	GR7	GR8	GR9	GR10	LEA
\$2614	\$2726	\$2837	\$2966	\$3078	\$3205	\$3335	\$3463	\$3592	\$3718	\$3848	\$4032



**1236** 60° Backless Curve (5 Legs)

COM Yardage: Total: 4.5 Yds. / Sdies: 1 Yds. / Top-Front-Rear: 3.5 Yds

COM	GR1	GR2	GR3	GR4	GR5	GR6	GR7	GR8	GR9	GR10	LEA
\$2795	\$2909	\$3021	\$3148	\$3262	\$3389	\$3518	\$3646	\$3775	\$3903	\$4030	\$4217

**OPTIONS**

Add upcharge to list price and code to model number

FR	CAL 133 (TB 133) Fire Retardant per yard	\$118	/yd.	2F0	Two Fabric Option	\$131	
MB	Moisture Barrier (1"-59"width)	\$164	ea.	GD1	Ratchet Ganging Device for Soft Seating	\$112	per pair
MB60	Moisture Barrier (60"and up)	\$262	ea.	TABFB-(L)	Fixed Blade Tablet (outside or inside, specify (L/R), shape A, B or C)	\$593	ea. tablet
WDL	Metal/Wood Legs	\$45	ea.	LAM5	Non-standard laminate (5 tablets or less)	\$554	ea. tablet
WDL-C	Chrome/Wood Legs	\$79	ea.	SST	Solid Surface Tablet Arm - add to tablet option	\$271	ea. tablet
PC	Polished Chrome Legs	\$45	ea.	SS5	Non-standard Solid Surface (5 tablets or less)	Call For Quote	

DIMENSIONS	Quattro
Seat Height:	18"
Overall Depth:	54"
Overall Width:	54"
Overall Height:	17"
Seat Depth:	27"
Qty./Wt.:	1 ea./90 lbs.



QUATTRO

**MODEL / DESCRIPTION / LIST PRICING**

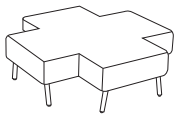

**1225** Quattro (8 Legs)

COM Yardage: Total: 6 Yds. / Top: 3 Yds. / Sides: 3 Yds.

COM	GR1	GR2	GR3	GR4	GR5	GR6	GR7	GR8	GR9	GR10	LEA
\$5879	\$6071	\$6264	\$6455	\$6648	\$6840	\$7033	\$7226	\$7417	\$7611	\$7802	\$7987

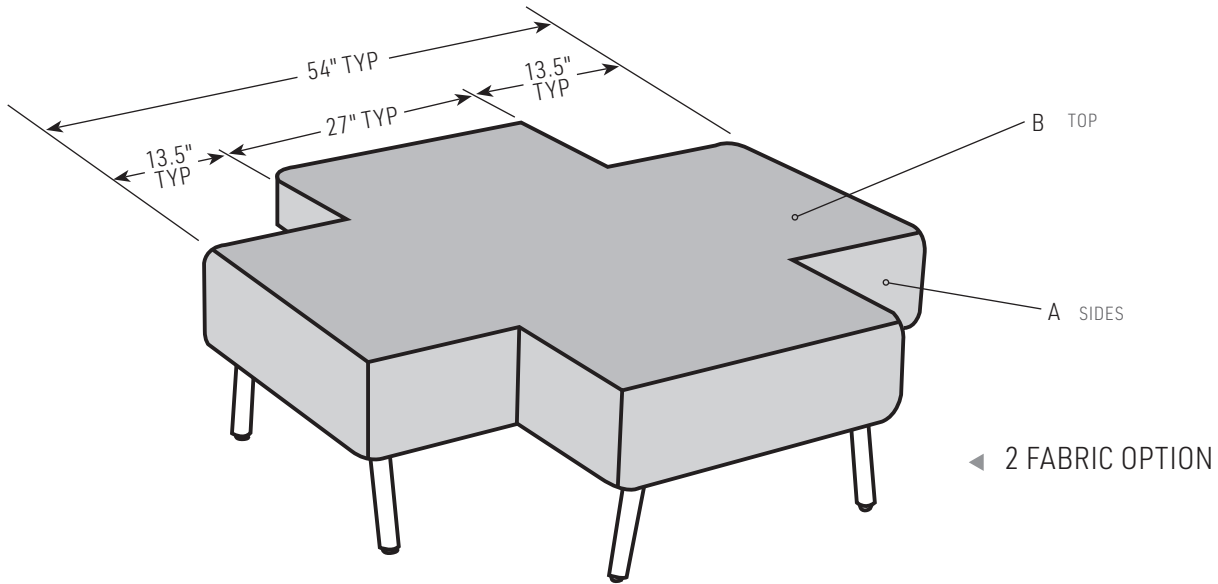

**OPTIONS**

Add upcharge to list price and code to model number

FR	CAL 133 (TB 133) Fire Retardant per yard	\$118	/yd.	GD1	Ratchet Ganging Device for Soft Seating	\$112	per pair
MB	Moisture Barrier (1"-59"width)	\$164	ea.	TABFB (-)	Fixed Blade Tablet (outside or inside, specify (L/R), shape A, B or C)	\$593	ea. tablet
WDL	Metal/Wood Legs	\$45	ea.	LAM5	Non-standard laminate (5 tablets or less)	\$554	ea. tablet
WDL-C	Chrome/Wood Legs	\$79	ea.	SST	Solid Surface Tablet Arm - add to tablet option	\$271	ea. tablet
PC	Polished Chrome Legs	\$45	ea.	SS5	Non-standard Solid Surface (5 tablets or less)	Call For Quote	
2FO	Two Fabric Option	\$131					

**Note:** Due to it's size, Moisture Barrier is priced at MB60 pricing.

**OPTIONS**

- CODE: FR - CAL 133 (TB 133) Fire Retardant
- CODE: MB - Moisture Barrier (up to 60" overall width)
- CODE: MB60 - Moisture Barrier (over 60" overall width)
- CODE: PC - Polished Chrome Legs
- CODE: WDL - Metal/Wood Legs. (Specify powder coat and wood color)
- CODE: WDL-C - Chrome/Wood Legs. (Specify wood color)
- CODE: 2FO - Two Fabric Option
- CODE: 3FO - Three Fabric Option
- CODE: PAC-L - Poly Arm Caps
- CODE: WAC-L - Wood Arm Caps
- CODE: BWAC - Wood Arm Caps for Box Arm
- CODE: TAB-( ) - Swivel Tablet (shape A, B or C, left or right arm)
- CODE: TABR1-( ) - Removable Tablet (shape A, B or C, left or right arm)
- CODE: TABR2-( ) - Removable Tablet (shape A, B or C, hardware both arms)
- CODE: LAM5 - Non-standard laminate for 5 or less tablets see options for upcharge
- CODE: SST - Solid Surface Tablet Arm
- CODE: SS5 - Non-standard Solid Surface top for 5 or less tablets

**Note:** Factory installed power/data available, see accessories online under the 'Products' tab.



SINGLE SEAT LOUNGE WITH OPTIONAL TABLET ARM AND METAL/WOOD LEGS



BARIATRIC LOUNGE

**TABLET SHAPES**

**Three Tablet Shapes::**

Choose from the three shapes shown and specify; A, B or C and left or right (outside tablet) when ordering.

Example: TABF-(A) Left - this would be a fixed shape A tablet on the left side (when seated).

**Laminate Top: Tops are 3/4"**

Tablet orders of 5 or less have 4 standard laminate colors:

- Wilsonart Black 1595-60
- Wilsonart Montana Walnut 7110K-78
- Formica Brite White 459-58
- Nevamar Silver Alu Metalx MXT003

Edge: 6F Multi-Ply

**Solid Surface Top:**

Tablet orders of 5 or less have 4 standard Corian colors:

- Bone
- Canyon
- Glacier White
- Silver Grey

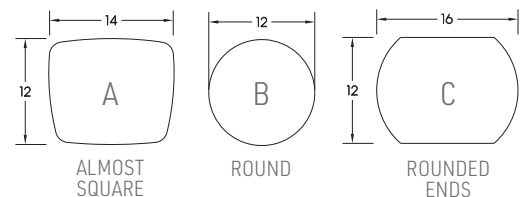

DIMENSIONS	22" Straight	30" Straight	44" Straight
Seat Depth:	21"	21"	21"
Seat Width:	22"	30"	44"
Seat Height:	18"	18"	18"
Overall Depth:	27"	27"	27"
Overall Width:	27"	35"	49"
Overall Height:	30"	30"	30"
Qty./Wt.:	1 ea./75 lbs.	1 ea./90 lbs.	1 ea./110 lbs.



TWO SEAT LOUNGE

**MODEL / DESCRIPTION / LIST PRICING**



**1200L** Single Seat Lounge

COM Yardage: Total: 5.5 Yds. / Back: 1.5 Yds. / Seat: 1.5 Yds. / Arms 2.5 Yds.

COM	GR1	GR2	GR3	GR4	GR5	GR6	GR7	GR8	GR9	GR10	LEA
\$3298	\$3492	\$3684	\$3876	\$4066	\$4260	\$4452	\$4645	\$4838	\$5029	\$5224	\$5408



**1202L** Bariatric Lounge

COM Yardage: Total: 6.5 Yds. / Back: 1.75 Yds. / Seat: 2.25 Yds. / Arms 2.5 Yds.

COM	GR1	GR2	GR3	GR4	GR5	GR6	GR7	GR8	GR9	GR10	LEA
\$4279	\$4523	\$4712	\$4904	\$5096	\$5289	\$5481	\$5675	\$5864	\$6060	\$6253	\$6435

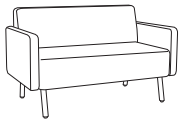

**1204L** Two Seat Lounge

COM Yardage: Total: 7.5 Yds. / Back: 2.5 Yds. / Seat: 2.5 Yds. / Arms 2.5 Yds.

COM	GR1	GR2	GR3	GR4	GR5	GR6	GR7	GR8	GR9	GR10	LEA
\$4790	\$5029	\$5224	\$5414	\$5607	\$5799	\$5991	\$6183	\$6377	\$6568	\$6763	\$6946

**OPTIONS**

Add upcharge to list price and code to model number

FR	CA133 Fire Retardant per yard	\$118	/yd.	3FO	Three Fabric Option	\$199	
MB	Moisture Barrier (1"-59"width)	\$164	ea.	TAB-( )	Swivel Tablet (specify A, B or C, left or right arm)	\$653	ea. tablet
PAC	Poly Arm Cap - Standard Black/Charcoal (Slim Arm)	\$89	ea.	TABR1-( )	Removable Tablet (specify A, B or C, left or right arm)	\$756	ea. tablet
WAC	Wood Arm Cap (Slim Arm)	\$116	ea.	TABR2-( )	Removable Tablet (specify A, B or C both arm openings)	\$893	ea. tablet
WDL	Metal/Wood Legs	\$45	ea.	LAM5	Non-standard laminate (5 tablets or less)	\$554	ea. tablet
WDL-C	Chrome/Wood Legs	\$79	ea.	SST	Solid Surface Tablet Arm - add to tablet option	\$271	ea. tablet
PC	Polished Chrome Legs	\$45	ea.	SS5	Non-standard Solid Surface (5 tablets or less)	Call For Quote	
2FO	Two Fabric Option	\$131					

DIMENSIONS	Single Hideout	Two Seat Hideout
Seat Depth:	20"	20"
Seat Width:	30"	44"
Seat Height:	18"	18"
Overall Depth:	28"	28"
Overall Width:	32"	46"
Overall Height:	48"	48"
Qty./Wt.:	1 ea./150 lbs.	1 ea./175 lbs.



TWO SEAT HIDEOUT WITH 22" BOLSTERS  
WOOD LEGS AND DIXON LAPTOP TABLE



HIDEOUT PROFILE VIEW

### MODEL / DESCRIPTION / LIST PRICING



#### 1222 Single Hideout (4 Legs)

COM	GR1	GR2	GR3	GR4	GR5	GR6	GR7	GR8	GR9	GR10	LEA
\$5705	\$5854	\$6014	\$6188	\$6346	\$6521	\$6697	\$6872	\$7049	\$7225	\$7436	\$7638

COM Yardage: Seat: 2.75 Yds. / Back: 2 Yds.

Panels Total: 8 Yds. / Outside 4 Yds. / Inside 4 Yds.



#### 1224 Two Seat Hideout (4 Legs)

COM	GR1	GR2	GR3	GR4	GR5	GR6	GR7	GR8	GR9	GR10	LEA
\$7062	\$7276	\$7485	\$7696	\$7905	\$8116	\$8329	\$8539	\$8749	\$8959	\$9171	\$9370

COM Yardage: Seat: 3.75 Yds. / Back: 1.5 Yds.

Panels Total: 9 Yds. / Outside 4.5 Yds. / Inside 4.5 Yds.

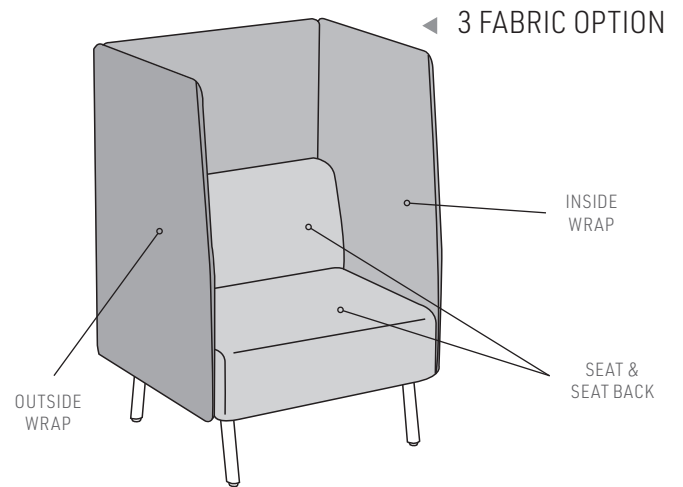
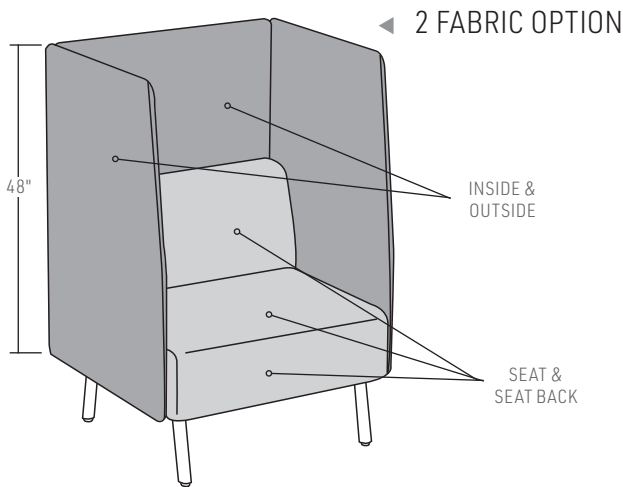

NOTE: 1.5" THICK FINISHED PANEL  
SHIPPED COMPLETELY ASSEMBLED

### OPTIONS

Add upcharge to list price and code to model number

FR	CAL 133 (TB 133) Fire Retardant per yard	\$118	/yd.	PC	Polished Chrome Legs	\$45	ea.
MB	Moisture Barrier (1"-59"width)	\$164	ea.	2FO	Two Fabric Option	\$131	
WDL	Metal/Wood Legs	\$45	ea.	3FO	Three Fabric Option	\$199	
WDL-C	Chrome/Wood Legs	\$79	ea.	GD1	Ratchet Ganging Device for Soft Seating	\$112	per pair



DIMENSIONS	Single Hideout	Two Seat Hideout
Seat Depth:	20"	20"
Seat Width:	30"	44"
Seat Height:	18"	18"
Arm Height:	24.5"	24.5"
Overall Depth:	28"	28"
Overall Width:	40"	54"
Overall Height:	48"	48"
Qty./Wt.:	1 ea./180 lbs.	1 ea./195 lbs.



LAGUNA TWO SEAT HIDEOUT WITH BOX ARM AND  
OPTIONAL BOX ARM TABLE AND POWER

**Laminate Top Note:**

- Tops are 3/4" laminate
- Std with edge 6F multi-exposed core

**MODEL / DESCRIPTION / LIST PRICING**



**1222A-(L/R) Single Hideout w/Box Arm (4 Legs)**

COM	GR1	GR2	GR3	GR4	GR5	GR6	GR7	GR8	GR9	GR10	LEA
\$6816	\$6946	\$7084	\$7237	\$7374	\$7528	\$7681	\$7834	\$7989	\$8143	\$8328	\$8503

**COM Yardage:** Seat: 2.25 Yds. / Back: 1.5 Yds. / Box Arms: 2 Yds.  
Panels Total: 9 Yds. / Outside 4.5 Yds. / Inside 4.5 Yds.

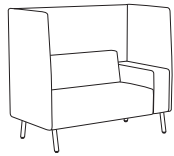

**1224A-(L/R) Two Seat Hideout w/Box Arm (4 Legs)**

COM	GR1	GR2	GR3	GR4	GR5	GR6	GR7	GR8	GR9	GR10	LEA
\$7398	\$7528	\$7667	\$7821	\$7958	\$8110	\$8265	\$8420	\$8571	\$8725	\$8909	\$9084

**COM Yardage:** Seat: 2.75 Yds. / Back: 2 Yds. / Box Arms: 2 Yds.  
Panels Total: 10 Yds. / Outside 5 Yds. / Inside 5 Yds.

**Hideout Box Arm Note:**

When sitting, specify right or left arm.

**BOX ARM TABLE & ARTICULATING TABLE NOTES**

**Box Arm Table and Articulating Tablet orders of 5 or less:**

**Laminate Top: Tops are 3/4"**

4 standard laminate colors:

- Wilsonart Black 1595-60
- Wilsonart Montana Walnut 7110K-78
- Formica Brite White 459-58
- Nevamar Silver Alu Metalx MXT003

Edge: 6F Multi-Ply

**Solid Surface Top:**

Box Arm Table only - 4 standard Corian colors (solid surface):

- Bone
- Canyon
- Glacier White
- Silver Grey

Articulating tablet available in  
Shape F only  
(Solid surface not available)

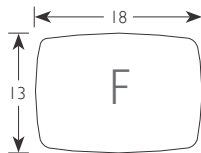

ALMOST  
RECTANGLE

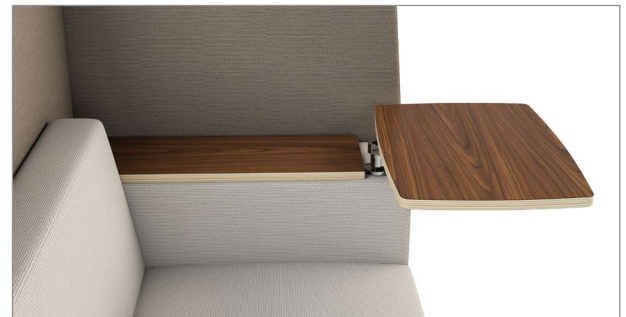

HIDEOUT BOX ARM SHOWN WITH TABLE AND ARTICULATING TABLET OPTIONS

**OPTIONS**

Add upcharge to list price and code to model number

FR	CAL 133 (TB 133) Fire Retardant per yard	\$118	/yd.
MB	Moisture Barrier (1"-59"width)	\$164	ea.
WDL	Metal/Wood Legs	\$45	ea.
WDL-C	Chrome/Wood Legs	\$79	ea.
PC	Polished Chrome Legs	\$45	ea.
2FO	Two Fabric Option	\$131	
3FO	Three Fabric Option	\$199	
GD1	Ratchet Ganging Device for Soft Seating	\$112	per pair

BWAC	Wood Arm Cap (Box Arm)	\$307	ea.
LAM5	Non-standard laminate (5 tablets or less)	\$554	ea. tablet
SST	Solid Surface Table - add to table option	\$271	ea. tablet
SS5	Non-standard Solid Surface (5 tables or less)	Call For Quote	
HBA-L	Box Arm + Table	\$467	
HBA-T	Box Arm + Articulating Tablet	\$841	
HBA-LT	Box Arm + Table + Articulating Tablet	\$1346	

DIMENSIONS	22" Bolster	30" Bolster	44" Bolster	12"x20" Pillow	16"x16" Pillow
Overall Depth:	6"	6"	6"	4"	4"
Overall Width:	22"	30"	44"	20"	16"
Overall Height:	6"	6"	6"	12"	16"
Qty./Wt.:	1 ea./25 lbs.	1 ea./25 lbs.	1 ea./25 lbs.	1 ea./25 lbs.	1 ea./25 lbs.



LAGUNA TWO SEAT HIDEOUT WITH 44" BOLSTER

**MODEL / DESCRIPTION / LIST PRICING**



**1219-22** 22" Round Bolster

COM Yardage: Total: .75 Yds.

COM	GR1	GR2	GR3	GR4	GR5	GR6	GR7	GR8	GR9	GR10	LEA
\$462	\$497	\$515	\$536	\$560	\$582	\$605	\$632	\$653	\$676	\$709	\$835



**1219-30** 30" Round Bolster

COM Yardage: Total: 1 Yds.

COM	GR1	GR2	GR3	GR4	GR5	GR6	GR7	GR8	GR9	GR10	LEA
\$578	\$617	\$646	\$670	\$699	\$726	\$754	\$784	\$814	\$849	\$883	\$1042



**1219-44** 44" Round Bolster

COM Yardage: Total: 1.5 Yds.

COM	GR1	GR2	GR3	GR4	GR5	GR6	GR7	GR8	GR9	GR10	LEA
\$739	\$792	\$819	\$854	\$888	\$922	\$961	\$999	\$1040	\$1080	\$1123	\$1328



**1220** 12" x 20" Rectangle Pillow

COM Yardage: Total: .75 Yds.

COM	GR1	GR2	GR3	GR4	GR5	GR6	GR7	GR8	GR9	GR10	LEA
\$572	\$612	\$638	\$664	\$690	\$718	\$746	\$775	\$806	\$838	\$872	\$1034



**1221** 16" x 16" Square Pillow

COM Yardage: Total: .75 Yds.

COM	GR1	GR2	GR3	GR4	GR5	GR6	GR7	GR8	GR9	GR10	LEA
\$608	\$649	\$674	\$704	\$731	\$761	\$793	\$820	\$855	\$888	\$925	\$1095

**OPTIONS**

Add upcharge to list price and code to model number

FR	CAL 133 (TB 133) Fire Retardant per yard	\$118	/yd.	MB	Moisture Barrier (up to 60" overall width)	\$164	ea.
----	--	-------	------	----	--	-------	-----

DIMENSIONS	22" Straight	44" Straight	66" Straight
Overall Depth:	20"	20"	20"
Overall Width:	22"	44"	66"
Overall Height:	18"	18"	18"
Qty./Wt.:	1 ea./58 lbs.	1 ea./68 lbs.	1 ea./85 lbs.



BENCH W/CENTER TABLE



44" BENCH

**MODEL / DESCRIPTION / LIST PRICING**



**1254** 22" W Straight Bench (4 Legs)

COM Yardage: Total: 2 Yds. / Sides: 1 Yds. / Top: 1 Yds.

COM	GR1	GR2	GR3	GR4	GR5	GR6	GR7	GR8	GR9	GR10	LEA
\$1508	\$1619	\$1731	\$1859	\$1972	\$2101	\$2229	\$2356	\$2487	\$2614	\$2740	\$2923



**1256** 44" W Straight Bench (4 Legs)

COM Yardage: Total: 3 Yds. / Sides: 1.5 Yds. / Top: 1.5 Yds.

COM	GR1	GR2	GR3	GR4	GR5	GR6	GR7	GR8	GR9	GR10	LEA
\$2593	\$2785	\$2978	\$3170	\$3362	\$3555	\$3747	\$3940	\$4133	\$4324	\$4519	\$4701

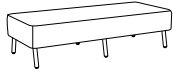

**1258** 66" W Straight Bench (6 Legs)

COM Yardage: Total: 4 Yds. / Sides: 2 Yds. / Top: 2 Yds.

COM	GR1	GR2	GR3	GR4	GR5	GR6	GR7	GR8	GR9	GR10	LEA
\$3027	\$3218	\$3411	\$3603	\$3796	\$3990	\$4181	\$4374	\$4566	\$4757	\$4949	\$5135

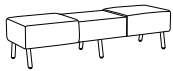

**1258T** 66" W Straight Bench with Center **LAMINATE** Table (6 Legs)

COM Yardage: Total: 4 Yds. / Sides: 2 Yds. / Top: 2 Yds.

COM	GR1	GR2	GR3	GR4	GR5	GR6	GR7	GR8	GR9	GR10	LEA
\$3235	\$3427	\$3619	\$3813	\$4005	\$4198	\$4387	\$4580	\$4772	\$4966	\$5158	\$5342

**1258V** 66" W Straight Bench with Center **VENEER** Table (6 Legs)

COM	GR1	GR2	GR3	GR4	GR5	GR6	GR7	GR8	GR9	GR10	LEA
\$3399	\$3592	\$3783	\$3974	\$4170	\$4360	\$4553	\$4745	\$4937	\$5129	\$5323	\$5507

**OPTIONS**

Add upcharge to list price and code to model number

FR	CAL 133 (TB 133) Fire Retardant per yard	\$118	/yd.
MB	Moisture Barrier (1"-59"width)	\$164	ea.
MB60	Moisture Barrier (60"and up)	\$262	ea.
PC	Polished Chrome Legs	\$45	ea.

WDL	Metal/Wood Legs	\$45	ea.
WDL-C	Chrome/Wood Legs	\$79	ea.
2FO	Two Fabric Option	\$131	

DIMENSIONS	24" Dia Ottoman	30" Dia Ottoman	36" Dia Ottoman	42" Dia Ottoman
Overall Depth:	24"	30"	36"	42"
Overall Width:	24"	30"	36"	42"
Overall Height:	16"	16"	16"	16"
Qty./Wt.:	1 ea./20 lbs.	1 ea./29 lbs.	1 ea./42 lbs.	1 ea./59 lbs.



ROUND OTTOMAN 24" DIAMETER

**MODEL / DESCRIPTION / LIST PRICING**



**1238** 24" Diameter Ottoman (4 Legs)

COM Yardage: Total: 2.25 Yds. / Sides: 1.5 Yds. / Top: .75 Yds.

COM	GR1	GR2	GR3	GR4	GR5	GR6	GR7	GR8	GR9	GR10	LEA
\$1587	\$1780	\$1972	\$2166	\$2356	\$2549	\$2740	\$2936	\$3126	\$3318	\$3511	\$3695



**1240** 30" Diameter Ottoman (4 Legs)

COM Yardage: Total: 2.75 Yds. / Sides: 1.75 Yds. / Top: 1 Yds.

COM	GR1	GR2	GR3	GR4	GR5	GR6	GR7	GR8	GR9	GR10	LEA
\$1883	\$2073	\$2265	\$2459	\$2651	\$2845	\$3035	\$3227	\$3421	\$3614	\$3804	\$3991

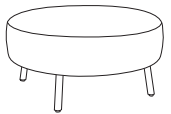

**1242** 36" Diameter Ottoman (4 Legs)

COM Yardage: Total: 3.25 Yds. / Sides: 2 Yds. / Top: 1.25 Yds.

COM	GR1	GR2	GR3	GR4	GR5	GR6	GR7	GR8	GR9	GR10	LEA
\$2059	\$2249	\$2442	\$2636	\$2827	\$3021	\$3213	\$3404	\$3597	\$3790	\$3981	\$4168

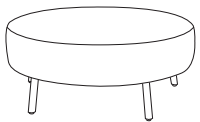

**1244** 42" Diameter Ottoman (5 Legs)

COM Yardage: Total: 3.75 Yds. / Sides: 2.25 Yds. / Top: 1.5 Yds.

COM	GR1	GR2	GR3	GR4	GR5	GR6	GR7	GR8	GR9	GR10	LEA
\$2507	\$2700	\$2892	\$3085	\$3274	\$3470	\$3663	\$3852	\$4046	\$4239	\$4432	\$4616

**OPTIONS**

Add upcharge to list price and code to model number

FR	CAL 133 (TB 133) Fire Retardant per yard	\$118	/yd.
MB	Moisture Barrier (1"-59"width)	\$164	ea.
PC	Polished Chrome Legs	\$45	ea.

WDL	Metal/Wood Legs	\$45	ea.
WDL-C	Chrome/Wood Legs	\$79	ea.
2FO	Two Fabric Option	\$131	

DIMENSIONS	18" Dia Ottoman	24" Dia Ottoman	30" Dia Ottoman	36" Dia Ottoman	42" Dia Ottoman
Overall Depth:	18"	24"	30"	36"	42"
Overall Width:	18"	24"	30"	36"	42"
Overall Height:	16"	16"	16"	16"	16"
Qty./Wt.:	1 ea./14 lbs.	1 ea./22 lbs.	1 ea./35 lbs.	1 ea./51 lbs.	1 ea./69 lbs.



ROUND OTTOMAN WITH OPTIONAL CASTERS

**Note:** glides are installed

**MODEL / DESCRIPTION / LIST PRICING**



**1237NL** 18" Diameter Ottoman No Legs (4 - 2" Casters Needed)

COM Yardage: Total: 2.25 Yds. / Top: .75 Yds. / Sides: 1.5 Yds.

COM	GR1	GR2	GR3	GR4	GR5	GR6	GR7	GR8	GR9	GR10	LEA
\$1288	\$1481	\$1675	\$1865	\$2059	\$2249	\$2442	\$2636	\$2827	\$3021	\$3213	\$3398

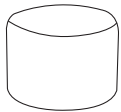

**1238NL** 24" Diameter Ottoman No Legs (4 casters needed)

COM Yardage: Total: 2.25 Yds. / Top: .75 Yds. / Sides: 1.5 Yds.

COM	GR1	GR2	GR3	GR4	GR5	GR6	GR7	GR8	GR9	GR10	LEA
\$1465	\$1658	\$1851	\$2042	\$2236	\$2428	\$2618	\$2812	\$3004	\$3197	\$3389	\$3574

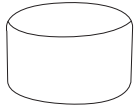

**1240NL** 30" Diameter Ottoman No Legs (4 casters needed)

COM Yardage: Total: 2.75 Yds. / Top: 1 Yds. / Sides: 1.75 Yds.

COM	GR1	GR2	GR3	GR4	GR5	GR6	GR7	GR8	GR9	GR10	LEA
\$1737	\$1931	\$2121	\$2315	\$2507	\$2700	\$2892	\$3085	\$3274	\$3470	\$3663	\$3846

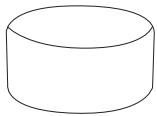

**1242NL** 36" Diameter Ottoman No Legs (4 casters needed)

COM Yardage: Total: 4.25 Yds. / Top: 1.25 Yds. / Sides: 3 Yds.

COM	GR1	GR2	GR3	GR4	GR5	GR6	GR7	GR8	GR9	GR10	LEA
\$1901	\$2091	\$2285	\$2476	\$2670	\$2863	\$3053	\$3246	\$3439	\$3631	\$3824	\$4007

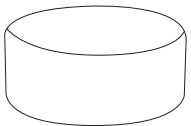

**1244NL** 42" Diameter Ottoman No Legs (5 casters needed)

COM Yardage: Total: 4.5 Yds. / Top: 1.5 Yds. / Sides: 3 Yds.

COM	GR1	GR2	GR3	GR4	GR5	GR6	GR7	GR8	GR9	GR10	LEA
\$2315	\$2507	\$2700	\$2892	\$3085	\$3274	\$3470	\$3663	\$3852	\$4046	\$4239	\$4421

**OPTIONS**

Add upcharge to list price and code to model number

FR	CAL 133 (TB 133) Fire Retardant per yard	\$118	/yd.
MB	Moisture Barrier (1"-59"width)	\$164	ea.
2FO	Two Fabric Option	\$131	

CAS2	2" Locking Casters - Black (18" size Only)	\$28	ea.
CAS3	3" Locking Casters - Black (not available on 18" size)	\$34	ea.

DIMENSIONS	24" Square	30" Square	36" Square	42" Square
Overall Depth:	24"	30"	36"	42"
Overall Width:	24"	30"	36"	42"
Overall Height:	16"	16"	16"	16"
Qty./Wt.:	1 ea./24 lbs.	1 ea./37 lbs.	1 ea./54 lbs.	1 ea./75 lbs.



30" ALMOST SQUARE OTTOMAN

**MODEL / DESCRIPTION / LIST PRICING**



**1246** 24" Almost Square Ottoman (4 Legs)

COM Yardage: Total: 2 Yds. / Sides: 1 Yds. / Top: 1 Yds.

COM	GR1	GR2	GR3	GR4	GR5	GR6	GR7	GR8	GR9	GR10	LEA
\$1637	\$1826	\$2020	\$2211	\$2406	\$2596	\$2791	\$2982	\$3173	\$3364	\$3557	\$3742



**1248** 30" Almost Square Ottoman (4 Legs)

COM Yardage: Total: 2.5 Yds. / Sides: 1.5 Yds. / Top: 1 Yds.

COM	GR1	GR2	GR3	GR4	GR5	GR6	GR7	GR8	GR9	GR10	LEA
\$1902	\$2095	\$2286	\$2478	\$2671	\$2864	\$3057	\$3247	\$3440	\$3636	\$3826	\$4009



**1250** 36" Almost Square Ottoman (4 Legs)

COM Yardage: Total: 3 Yds. / Sides: 1.75 Yds. / Top: 1.25 Yds.

COM	GR1	GR2	GR3	GR4	GR5	GR6	GR7	GR8	GR9	GR10	LEA
\$2081	\$2273	\$2466	\$2656	\$2849	\$3041	\$3235	\$3427	\$3619	\$3813	\$4005	\$4186

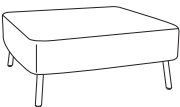

**1252** 42" Almost Square Ottoman (4 Legs)

COM Yardage: Total: 3.25 Yds. / Sides: 1.75 Yds. / Top: 1.5 Yds.

COM	GR1	GR2	GR3	GR4	GR5	GR6	GR7	GR8	GR9	GR10	LEA
\$2551	\$2744	\$2938	\$3129	\$3320	\$3513	\$3706	\$3900	\$4092	\$4282	\$4476	\$4661

**OPTIONS**

Add upcharge to list price and code to model number

FR	CAL 133 (TB 133) Fire Retardant per yard	\$118	/yd.
MB	Moisture Barrier (1"-59"width)	\$164	ea.
PC	Polished Chrome Legs	\$45	ea.

WDL	Metal/Wood Legs	\$45	ea.
WDL-C	Chrome/Wood Legs	\$79	ea.
2FO	Two Fabric Option	\$131	

DIMENSIONS	18" Square	24" Square	30" Square	36" Square	42" Square	48" Square
Overall Depth:	18"	24"	30"	36"	42"	48"
Overall Width:	18"	24"	30"	36"	42"	48"
Overall Height:	16"	16"	16"	16"	16"	16"
Qty./Wt.:	1 ea./17 lbs.	1 ea./29 lbs.	1 ea./45 lbs.	1 ea./65 lbs.	1 ea./88 lbs.	1 ea./113 lbs.

**Note:** glides are installed



24" OTTOMAN WITH OPTIONAL  
TABLET ARMS & CASTERS

**MODEL / DESCRIPTION / LIST PRICING**

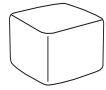

**1245NL** 18" Almost Square Ottoman No Legs (4 - 2" Casters Needed)

COM Yardage: Total: 2.25 Yds. / Top: .75 Yds. / Sides: 1.5 Yds.

COM	GR1	GR2	GR3	GR4	GR5	GR6	GR7	GR8	GR9	GR10	LEA
\$1328	\$1520	\$1712	\$1906	\$2098	\$2291	\$2480	\$2674	\$2866	\$3059	\$3252	\$3437

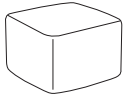

**1246NL** 24" Almost Square Ottoman No Legs (4 casters needed)

COM Yardage: Total: 2.5 Yds. / Top: .75 Yds. / Sides: 1.75 Yds.

COM	GR1	GR2	GR3	GR4	GR5	GR6	GR7	GR8	GR9	GR10	LEA
\$1509	\$1702	\$1892	\$2085	\$2279	\$2471	\$2663	\$2856	\$3049	\$3241	\$3434	\$3616

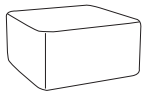

**1248NL** 30" Almost Square Ottoman No Legs (4 casters needed)

COM Yardage: Total: 3.5 Yds. / Top: 1 Yds. / Sides: 2.5 Yds.

COM	GR1	GR2	GR3	GR4	GR5	GR6	GR7	GR8	GR9	GR10	LEA
\$1756	\$1945	\$2140	\$2332	\$2524	\$2717	\$2910	\$3099	\$3294	\$3486	\$3679	\$3863

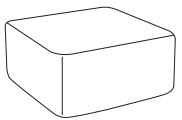

**1250NL** 36" Almost Square Ottoman No Legs (4 casters needed)

COM Yardage: Total: 4 Yds. / Top: 1.25 Yds. / Sides: 2.75 Yds.

COM	GR1	GR2	GR3	GR4	GR5	GR6	GR7	GR8	GR9	GR10	LEA
\$1920	\$2114	\$2304	\$2497	\$2689	\$2882	\$3076	\$3267	\$3461	\$3651	\$3845	\$4028



**1252NL** 42" Almost Square Ottoman No Legs (4 casters needed)

COM Yardage: Total: 4.5 Yds. / Top: 1.5 Yds. / Sides: 3 Yds.

COM	GR1	GR2	GR3	GR4	GR5	GR6	GR7	GR8	GR9	GR10	LEA
\$2355	\$2548	\$2739	\$2935	\$3124	\$3317	\$3510	\$3703	\$3894	\$4085	\$4277	\$4463

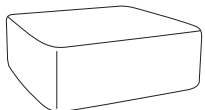

**1254NL** 48" Almost Square Ottoman No Legs (4 casters needed)

COM Yardage: Total: 5.25 Yds. / Top: 1.75 Yds. / Sides: 3.5 Yds.

COM	GR1	GR2	GR3	GR4	GR5	GR6	GR7	GR8	GR9	GR10	LEA
\$3172	\$3341	\$3510	\$3676	\$3845	\$4014	\$4181	\$4349	\$4518	\$4684	\$4854	\$5014

**OPTIONS**

Add upcharge to list price and code to model number

FR	CAL 133 (TB 133) Fire Retardant per yard	\$118	/yd.	TABFB-( )	Fixed Blade Tablet (outside or inside, specify (L/R), shape A, B or C)	\$593	ea. tablet
MB	Moisture Barrier (1"-59"width)	\$164	ea.	LAM5	Non-standard laminate (5 tablets or less)	\$554	ea. tablet
2FO	Two Fabric Option	\$128		SST	Solid Surface Tablet Arm - add to tablet option	\$271	
CAS2	2" Locking Casters - Black (18" size Only)	\$28	ea.	SS5	Non-standard Solid Surface (5 tablets or less)	Call For Quote	
CAS3	3" Locking Casters - Black (not available on 18" size)	\$34	ea.				

DIMENSIONS	24" Dia	30" Dia	36" Dia	42" Dia
Overall Depth:	24"	30"	36"	42"
Overall Width:	24"	30"	36"	42"
Overall Height:	17"	17"	17"	17"
Qty./Wt.:	1 ea./20 lbs.	1 ea./29 lbs.	1 ea./42 lbs.	1 ea./59 lbs.



30" DIAMETER OCCASIONAL TABLE

**Laminate Top Note:**

- Tops are 3/4" laminate
- Std with 6F Multi-Ply

**MODEL / DESCRIPTION / LIST PRICING**



**1238/T** 24" Diameter Occasional Table (4 Legs)

COM Yardage: Total: 1.5 Yds.

COM	GR1	GR2	GR3	GR4	GR5	GR6	GR7	GR8	GR9	GR10	LEA
\$2551	\$2735	\$2915	\$3099	\$3284	\$3467	\$3651	\$3832	\$4017	\$4200	\$4383	\$4559



**1240/T** 30" Diameter Occasional Table (4 Legs)

COM Yardage: Total: 1.75 Yds.

COM	GR1	GR2	GR3	GR4	GR5	GR6	GR7	GR8	GR9	GR10	LEA
\$3042	\$3225	\$3407	\$3591	\$3776	\$3959	\$4140	\$4323	\$4508	\$4691	\$4874	\$5050

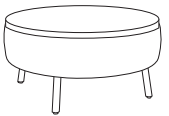

**1242/T** 36" Diameter Occasional Table (4 Legs)

COM Yardage: Total: 2 Yds.

COM	GR1	GR2	GR3	GR4	GR5	GR6	GR7	GR8	GR9	GR10	LEA
\$3615	\$3799	\$3980	\$4165	\$4348	\$4532	\$4714	\$4898	\$5080	\$5264	\$5447	\$5622

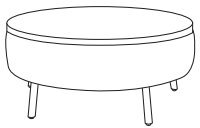

**1244/T** 42" Diameter Occasional Table (5 Legs)

COM Yardage: Total: 2.25 Yds.

COM	GR1	GR2	GR3	GR4	GR5	GR6	GR7	GR8	GR9	GR10	LEA
\$4566	\$4747	\$4931	\$5115	\$5299	\$5481	\$5664	\$5848	\$6031	\$6213	\$6397	\$6572

**OPTIONS**

Add upcharge to list price and code to model number

FR	CAL 133 (TB 133) Fire Retardant per yard	\$118	/yd.
PC	Polished Chrome Legs	\$45	ea.

WDL	Metal/Wood Legs	\$45	ea.
WDL-C	Chrome/Wood Legs	\$79	ea.



DIMENSIONS	18" Dia	24" Dia	30" Dia	36" Dia	42" Dia
Overall Depth:	18"	24"	30"	36"	42"
Overall Width:	18"	24"	30"	36"	42"
Overall Height:	17"	17"	17"	17"	17"
Qty./Wt.:	1 ea./14 lbs.	1 ea./22 lbs.	1 ea./35 lbs.	1 ea./51 lbs.	1 ea./69 lbs.



ROUND OCCASIONAL TABLE WITH NO LEGS

**Laminate Top Note:**

- Tops are 3/4" laminate
- Std with 6F Multi-Ply

**Note:** glides are installed

**MODEL / DESCRIPTION / LIST PRICING**



**1237NL/T 18" Diameter Occasional Table No Legs (4 - 2" Casters Needed)**

COM Yardage: Total: 1.5 Yds.

COM	GR1	GR2	GR3	GR4	GR5	GR6	GR7	GR8	GR9	GR10	LEA
\$2214	\$2398	\$2580	\$2763	\$2948	\$3130	\$3315	\$3496	\$3679	\$3863	\$4046	\$4220

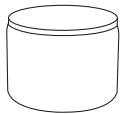

**1238NL/T 24" Diameter Occasional Table No Legs (4 casters needed)**

COM Yardage: Total: 2 Yds.

COM	GR1	GR2	GR3	GR4	GR5	GR6	GR7	GR8	GR9	GR10	LEA
\$2435	\$2618	\$2802	\$2984	\$3166	\$3352	\$3535	\$3716	\$3900	\$4083	\$4268	\$4442

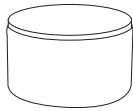

**1240NL/T 30" Diameter Occasional Table No Legs (4 casters needed)**

COM Yardage: Total: 2.25 Yds.

COM	GR1	GR2	GR3	GR4	GR5	GR6	GR7	GR8	GR9	GR10	LEA
\$2902	\$3088	\$3271	\$3453	\$3638	\$3820	\$4005	\$4186	\$4369	\$4554	\$4736	\$4912

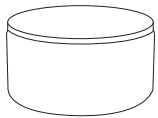

**1242NL/T 36" Diameter Occasional Table No Legs (4 casters needed)**

COM Yardage: Total: 2.5 Yds.

COM	GR1	GR2	GR3	GR4	GR5	GR6	GR7	GR8	GR9	GR10	LEA
\$3465	\$3647	\$3831	\$4014	\$4198	\$4379	\$4564	\$4747	\$4930	\$5113	\$5297	\$5471

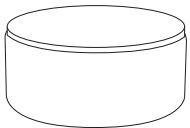

**1244NL/T 42" Diameter Occasional Table No Legs (5 casters needed)**

COM Yardage: Total: 3 Yds.

COM	GR1	GR2	GR3	GR4	GR5	GR6	GR7	GR8	GR9	GR10	LEA
\$4383	\$4566	\$4747	\$4931	\$5115	\$5299	\$5481	\$5664	\$5848	\$6031	\$6213	\$6391

**OPTIONS**

Add upcharge to list price and code to model number

FR	CAL 133 (TB 133) Fire Retardant per yard	\$118	/yd.
----	--	-------	------

CAS2	2" Black Casters (18" size Only)	\$28	ea.
CAS3	3" Black Casters (not available on 18" size)	\$34	ea.

DIMENSIONS	24" Square	30" Square	36" Square	42" Square
Overall Depth:	24"	30"	36"	42"
Overall Width:	24"	30"	36"	42"
Overall Height:	17"	17"	17"	17"
Qty./Wt.:	1 ea./24 lbs.	1 ea./37 lbs.	1 ea./54 lbs.	1 ea./75 lbs.



30" ALMOST SQUARE OCCASIONAL TABLE

**Laminate Top Note:**

- Tops are 3/4" laminate
- Std with 6F Multi-Ply

**MODEL / DESCRIPTION / LIST PRICING**



**1246/T** 24" Almost Square Occasional Table (4 Legs)

COM Yardage: Total: 1 Yds.

COM	GR1	GR2	GR3	GR4	GR5	GR6	GR7	GR8	GR9	GR10	LEA
\$2657	\$2842	\$3024	\$3208	\$3390	\$3574	\$3757	\$3941	\$4126	\$4307	\$4490	\$4666



**1248/T** 30" Almost Square Occasional Table (4 Legs)

COM Yardage: Total: 1.5 Yds.

COM	GR1	GR2	GR3	GR4	GR5	GR6	GR7	GR8	GR9	GR10	LEA
\$3105	\$3289	\$3473	\$3655	\$3838	\$4021	\$4204	\$4387	\$4571	\$4753	\$4937	\$5113



**1250/T** 36" Almost Square Occasional Table (4 Legs)

COM Yardage: Total: 1.75 Yds.

COM	GR1	GR2	GR3	GR4	GR5	GR6	GR7	GR8	GR9	GR10	LEA
\$3691	\$3873	\$4058	\$4240	\$4422	\$4608	\$4790	\$4975	\$5157	\$5338	\$5523	\$5698

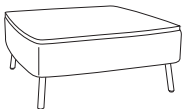

**1252/T** 42" Almost Square Occasional Table (4 Legs)

COM Yardage: Total: 1.75 Yds.

COM	GR1	GR2	GR3	GR4	GR5	GR6	GR7	GR8	GR9	GR10	LEA
\$4684	\$4865	\$5051	\$5233	\$5417	\$5600	\$5783	\$5968	\$6149	\$6332	\$6517	\$6691

**OPTIONS**

Add upcharge to list price and code to model number

FR	CAL 133 (TB 133) Fire Retardant per yard	\$118	/yd.
PC	Polished Chrome Legs	\$45	ea.

WDL	Metal/Wood Legs	\$45	ea.
WDL-C	Chrome/Wood Legs	\$79	ea.

DIMENSIONS	18" Square	24" Square	30" Square	36" Square	42" Square
Overall Depth:	18"	24"	30"	36"	42"
Overall Width:	18"	24"	30"	36"	42"
Overall Height:	17"	17"	17"	17"	17"
Qty./Wt.:	1 ea./17 lbs.	1 ea./29 lbs.	1 ea./45 lbs.	1 ea./65 lbs.	1 ea./88 lbs.

**Laminate Top Note:**

- Tops are 3/4" laminate
- Std with 6F Multi-Ply

**Note:** glides are installed



30" SQUARE OCCASIONAL TABLE  
WITH NO LEGS

**MODEL / DESCRIPTION / LIST PRICING**

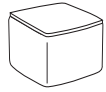

**1245NL/T 18" Almost Square Occasional Table - No Legs (4 - 2" Casters Needed)**

COM Yardage: Total: 1.5 Yds.

COM	GR1	GR2	GR3	GR4	GR5	GR6	GR7	GR8	GR9	GR10	LEA
\$2326	\$2509	\$2691	\$2875	\$3060	\$3243	\$3426	\$3608	\$3793	\$3975	\$4158	\$4333

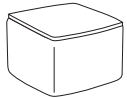

**1246NL/T 24" Almost Square Occasional Table - No Legs (4 casters needed)**

COM Yardage: Total: 1.75 Yds.

COM	GR1	GR2	GR3	GR4	GR5	GR6	GR7	GR8	GR9	GR10	LEA
\$2537	\$2720	\$2904	\$3087	\$3270	\$3453	\$3638	\$3821	\$4002	\$4186	\$4369	\$4544

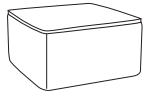

**1248NL/T 30" Almost Square Occasional Table - No Legs (4 casters needed)**

COM Yardage: Total: 2.5 Yds.

COM	GR1	GR2	GR3	GR4	GR5	GR6	GR7	GR8	GR9	GR10	LEA
\$2967	\$3149	\$3335	\$3517	\$3698	\$3882	\$4066	\$4248	\$4433	\$4615	\$4800	\$4974

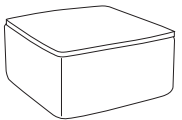

**1250NL/T 36" Almost Square Occasional Table - No Legs (4 casters needed)**

COM Yardage: Total: 2.75 Yds.

COM	GR1	GR2	GR3	GR4	GR5	GR6	GR7	GR8	GR9	GR10	LEA
\$3536	\$3722	\$3904	\$4087	\$4270	\$4453	\$4638	\$4820	\$5003	\$5187	\$5370	\$5545

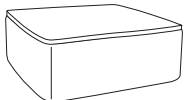

**1252NL/T 42" Almost Square Occasional Table - No Legs (4 casters needed)**

COM Yardage: Total: 3 Yds.

COM	GR1	GR2	GR3	GR4	GR5	GR6	GR7	GR8	GR9	GR10	LEA
\$4498	\$4680	\$4862	\$5048	\$5230	\$5412	\$5595	\$5778	\$5961	\$6146	\$6328	\$6504

**OPTIONS**

Add upcharge to list price and code to model number

FR	CAL 133 (TB 133) Fire Retardant per yard	\$118	/yd.
----	--	-------	------

CAS2	2" Black Casters (18" size Only)	\$28	ea.
CAS3	3" Black Casters (not available on 18" size)	\$34	ea.

