



RAVEN TABLE OF CONTENTS

Raven Specifications.....	2
Raven Banquette Options	3
Raven Banquette Pricing	4
Raven Banquette Privacy Panel Pricing	9
Raven Modular Options.....	10
Raven Modular Pricing.....	11
Raven Modular Privacy Panel Pricing.....	15
Raven Modular Backless Units	18
Raven Modular Individual Arms.....	20
Raven Modular Configurations	23
Raven Ottomans.....	25
Raven Benches	28
Raven Lounge Options.....	29
Raven Lounge Pricing	30
Raven Junior	31

RAVEN

The Raven collection offers an extensive variety of shapes and designs to fit a multitude of areas. The banquettes come in three different back heights, a choice of wood or metal legs or a plinth base, and a variety of privacy panels. The modular units offers straight or curved seating units, to create fun configurations, that have the flexibility to divide spaces in any open space. Raven also offers ottomans, lounge chairs and is complemented with Cabana tables to adapt to any design you dream up. Designed for higher education and any public space that requires long duration seating with comfort.



BANQUETTE



MODULAR



LOUNGE



OTTOMAN



CHILDREN'S

ORDERING INFORMATION

- | | |
|-----------------|----------------------------------|
| 1) Series Name | 4) Fabric Grade & Number |
| 2) Model Number | 5) Panel Laminate/Edge Selection |
| 3) Quantity | 6) Optional Items/Colors |

SOFT SEATING	WEIGHT LIMIT
1 Seat	500 lbs.
2 Seat	1000 lbs.
3 Seat	1500 lbs.

STANDARD BASE FINISHES

Metal Leg: Standard Powder Coat

OPTIONAL BASE FINISHES

Metal Leg: Polished Chrome or Standard Wood Stain

Wood Leg: Standard Wood Stain

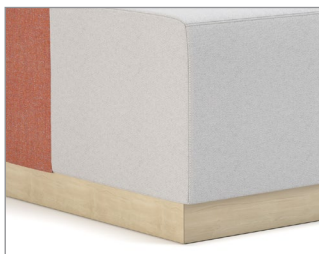

STANDARD BANQUETTE COMES WITH A FLUSH PLINTH BASE ON SIDES FOR GANGING, AND RECESSED FRONT.

GENERAL SPECIFICATIONS

Upholstery / Foam

Seat and back are covered in choice of fabric, vinyl, crypton, leather or COM. ERG uses only water based glues and adhesives in our upholstery process. All foam is fully bonded to frame. Seat cushions are 4" graded high resiliency (H.R.) block foam with back 3" (H.R.) foam, covered entirely with special bonded polyester fiber to protect final upholstery.

Frame Construction

Frame assembly is constructed of multi-ply hardwood, with tongue and groove construction. No sag-springs are installed in seat & back along with interlocking helicoil springs to prevent sagging and provide additional lower back and seat support.

Base Details

Leg: 2"RD X 3"H round tubular steel legs are standard.

Metal legs - Poly Vinyl glides

Wood legs - with Felt Pads

Castors: 3" Locking Casters

Optional Plinth Base (Available only on Banquettes): The optional base is available in a choice of laminate or unfinished so that you can add your own cover base or carpet (**clean out not available with plinth**)

Anchoring

Raven Banquettes are easy to anchor to the floor. Floor mount instructions can be provided by customer service. Hardware for anchoring bench to the floor is not included.

Note for Edge of privacy panels:

- Straight panels: available with 3MM PVC or laminate self edge. Select from any of our 3MM PVC edges in solid or wood tone, no custom colors available.
- Curved panels: will only be able available with laminate self edge.
- Both straight and curved panels: when combining straights and curved, ONLY self edge is available.

Raven Banquette
Available in 3 heights
27", 33" or 42"

OPTIONS

- CODE: FR - CAL 133 (TB 133) Fire Retardant
- CODE: MB -Moisture Barrier (1"-59"width)
- CODE: MB60 -Moisture Barrier (60"and up)
- CODE: MBB -Moisture Barrier Back-to-Back (1"-59"width)
- CODE: MBB60 -Moisture Barrier Back-to-Back (60"and up)
- CODE: LOW - Fully Upholstered Low Back - 27" OA Height
- CODE: WOD - Solid Maple Wood Legs with felt pads
- CODE: PC - Polished Chrome Legs
- CODE: CAS2 - 2" Locking Casters - Black
- CODE: CAS3 - 3" Locking Casters - Black
- CODE: 2FO - Two Fabric Option
- CODE: GD1 - Ratchet Ganging Device for Soft Seating
- CODE: GD2 - Flat Ganging Device for Soft Seating
- CODE: GBP - Ganging Brackets For Plinth Base
- CODE: CO - Clean Out (1"-59"width)
- CODE: CO1 - Clean Out (60"and up)
- CODE: COB - Clean Out Back-to-Back (1"-59"width)
- CODE: CO1B - Clean Out Back-to-Back (60"and up)
- CODE: FMG - Floor Mount Glide
- CODE: PB - Plinth Base (1"-59"width)
- CODE: PB60 - Plinth Base (60"and up)
- CODE: PBB - Plinth Base Back-to-Back (1"-59"width)
- CODE: PBB60 - Plinth Base Back-to-Back (60"and up)
- CODE: UFB - Unfinished Plinth Base
- CODE: RB1 - Recessed Plinth Base (1 Side only)
- CODE: RB2 - Recessed Plinth Base (2 Sides)



POLISHED CHROME LEGS



WOOD LEGS



TWO FABRIC OPTION



CLEANOUT

PLINTH OPTIONS
The Optional Plinth comes..



FLOOR MOUNT GLIDE



OPTIONAL RECESSED PLINTH BASE
AVAILABLE, ON ONE OR TWO SIDES.

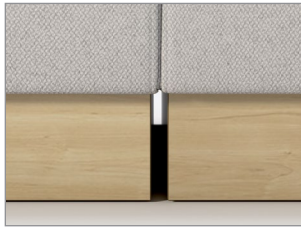

OPTIONAL STANDARD GANGED PLINTH
BASE, WITH 1/2" GAP BETWEEN BASES



LOW BACK
27.5"



STANDARD BACK
33"



HIGH BACK
42"
Available on
Banquette ONLY



HIGH BACK
48"
Available on
Banquette ONLY

Note: clean out options not available on plinth base units.

Note: Legs with Floor Mount Glide and standard capped legs cannot be mixed/ganged together.

DIMENSIONS	Straight Banquette
Seat Depth:	20"
Seat Height:	18"
Overall Depth:	27"
Overall Width:	48, 60, 72"
Overall Height:	33"
Qty./Wt.:	1 ea./150 lbs.



RAVEN BANQUETTE WITH OPTIONAL
PLINTH BASE AND POWER/DATA
UNIT

MODEL / DESCRIPTION / LIST PRICING

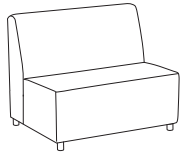

8372 48"W Straight Banquette (4 legs)

COM Yardage: Total: 7 Yds. / Back: 4 Yds. / Seat: 3 Yds.

COM	GR1	GR2	GR3	GR4	GR5	GR6	GR7	GR8	GR9	GR10	LEA
\$2942	\$3164	\$3384	\$3601	\$3824	\$4043	\$4264	\$4484	\$4705	\$4924	\$5145	\$5359

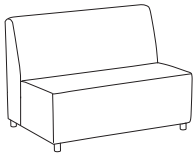

8374 60"W Straight Banquette (4 legs)

COM Yardage: Total: 9 Yds. / Back: 5 Yds. / Seat: 4 Yds.

COM	GR1	GR2	GR3	GR4	GR5	GR6	GR7	GR8	GR9	GR10	LEA
\$3676	\$3953	\$4227	\$4503	\$4776	\$5056	\$5329	\$5605	\$5881	\$6156	\$6432	\$6696

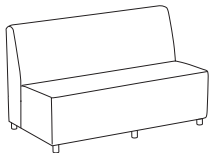

8376 72"W Straight Banquette (6 legs)

COM Yardage: Total: 11 Yds. / Back: 6 Yds. / Seat: 5 Yds.

COM	GR1	GR2	GR3	GR4	GR5	GR6	GR7	GR8	GR9	GR10	LEA
\$4624	\$4951	\$5283	\$5613	\$5944	\$6277	\$6606	\$6938	\$7266	\$7595	\$7928	\$8246

Note: Clean out option is only available when units are facing the same direction.

Note: clean out options not available on plinth base units.

OPTIONS

Add upcharge to list price and code to model number

FR	CAL 133 (TB 133) Fire Retardant per yard	\$118	/yd.
MB	Moisture Barrier (1"-59"width)	\$164	ea.
MB60	Moisture Barrier (60"and up)	\$262	ea.
LOW	Fully Upholstered Low Back - 27" OA Height	\$124	per unit
WOD	Solid Maple Wood Legs	\$32	ea.
PC	Polished Chrome Legs	\$34	ea.
CAS3	3" Locking Casters - Black	\$34	ea.
2FO	Two Fabric Option	\$131	per unit
GD1	Ratchet Ganging Device for Soft Seating	\$112	per pair
GD2	Flat Ganging Device for Soft Seating	\$112	per pair

GBP	Ganging Bracket for Plinth Base	\$286	per pair
CO	Clean Out (1"-59"width)	\$327	per unit
CO1	Clean Out (60"and up)	\$503	per unit
FMG	Floor Mount Glide	\$29	ea.
PB	Plinth Base (1"-59"width)	\$247	per unit
PB60	Plinth Base (60"and up)	\$418	per unit
UFB	Unfinished Plinth Base (deduct from plinth option)	Deduct \$80	
RB1	Recessed Base, 1 side	\$145	ea.
RB2	Recessed Base, 2 sides	\$287	ea.

DIMENSIONS	Corner Square Seat	Corner Curved Seat	Corner Curved Back Panel
Seat Depth:	21"	21"	21"
Seat Height:	18"	18"	18"
Overall Depth:	28"	28"	28"
Overall Width:	28"	28"	28"
Overall Height:	33"	33"	33"
Qty./Wt.:	1 ea./75 lbs.	1 ea./75 lbs.	1 ea./75 lbs.



CORNER UNIT - SQUARE SEAT



CORNER UNIT - CURVE SEAT



CORNER UNIT - CURVE BACK

MODEL / DESCRIPTION / LIST PRICING



8386 Corner Unit - **Square Seat** (4 legs)

COM Yardage: Total: 6.5 Yds. / Back: 4.5 Yds. / Seat: 2 Yds.

COM	GR1	GR2	GR3	GR4	GR5	GR6	GR7	GR8	GR9	GR10	LEA
\$3129	\$3346	\$3480	\$3619	\$3763	\$3916	\$4070	\$4235	\$4405	\$4580	\$4763	\$5630



8388 Corner Unit - **Curved Seat** (4 legs)

COM Yardage: Total: 6.5 Yds. / Back: 4.5 Yds. / Seat: 2 Yds.

COM	GR1	GR2	GR3	GR4	GR5	GR6	GR7	GR8	GR9	GR10	LEA
\$3402	\$3631	\$3769	\$3915	\$4064	\$4223	\$4385	\$4555	\$4733	\$4916	\$5108	\$6013



8389 Corner Unit - **Curved Back Panel** (4 legs)

COM Yardage: Total: 6.5 Yds. / Back: 4.5 Yds. / Seat: 2 Yds.

COM	GR1	GR2	GR3	GR4	GR5	GR6	GR7	GR8	GR9	GR10	LEA
\$3716	\$3964	\$4111	\$4270	\$4433	\$4600	\$4774	\$4961	\$5148	\$5346	\$5553	\$6522

Note: Clean out option is only available when units are facing the same direction.

OPTIONS

Add upcharge to list price and code to model number

FR	CAL 133 (TB 133) Fire Retardant per yard	\$118	/yd.
MB	Moisture Barrier (1"-59"width)	\$164	ea.
LOW	Fully Upholstered Low Back - 27" OA Height	\$124	
WOD	Solid Maple Wood Legs	\$32	ea.
PC	Polished Chrome Legs	\$34	ea.

CAS3	3" Locking Casters - Black	\$34	ea.
2FO	Two Fabric Option	\$131	
GD1	Ganging Device for Metal/Wood Legs	\$112	
GD2	Flat Ganging Device for Soft Seating	\$112	
CO	Clean Out (1"-59"width)	\$327	

DIMENSIONS	Back-to-Back Banquette
Seat Depth:	20"
Seat Height:	18"
Overall Depth:	51.5"
Overall Width:	48, 60, 72"
Overall Height:	33"
Qty./Wt.:	1 ea./280 lbs.



BACK-TO-BACK BANQUETTE WITH OPTIONAL CLEANOUT

MODEL / DESCRIPTION / LIST PRICING



8380 48"W Back-to-Back Banquette (6 legs)

COM Yardage: Total: 8 Yds. / Back: 3 Yds. / Seat: 5 Yds.

COM	GR1	GR2	GR3	GR4	GR5	GR6	GR7	GR8	GR9	GR10	LEA
\$5589	\$6008	\$6428	\$6843	\$7264	\$7681	\$8101	\$8519	\$8939	\$9356	\$9776	\$10180



8382 60"W Back-to-Back Banquette (6 legs)

COM Yardage: Total: 11 Yds. / Back: 5 Yds. / Seat: 6 Yds.

COM	GR1	GR2	GR3	GR4	GR5	GR6	GR7	GR8	GR9	GR10	LEA
\$6988	\$7511	\$8031	\$8553	\$9081	\$9604	\$10128	\$10650	\$11172	\$11696	\$12218	\$12722

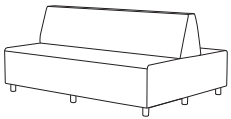

8384 72"W Back-to-Back Banquette (8 legs)

COM Yardage: Total: 13 Yds. / Back: 6 Yds. / Seat: 7 Yds.

COM	GR1	GR2	GR3	GR4	GR5	GR6	GR7	GR8	GR9	GR10	LEA
\$8596	\$9222	\$9852	\$10477	\$11104	\$11736	\$12364	\$12986	\$13617	\$14243	\$14875	\$15477

Note: To order Back to Back banquettes with privacy panel, the order will consist of two single straight units and privacy panel. The overall depth of these combined units with panel is 55". See page 8 for panel specs.

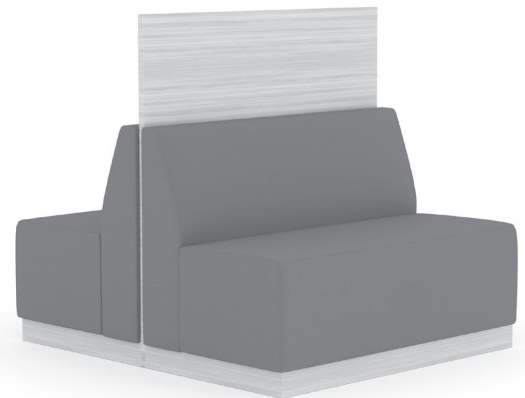

Note: Clean out option is only available when units are facing the same direction.

Note: clean out options not available on plinth base units.

OPTIONS

Add upcharge to list price and code to model number

FR	CAL 133 (TB 133) Fire Retardant per yard	\$118	/yd.
MBB	Moisture Barrier Back-to-Back (1"-59"width)	\$327	ea.
MBB60	Moisture Barrier Back-to-Back (60"and up)	\$522	ea.
WOD	Solid Maple Wood Legs	\$32	ea.
PC	Polished Chrome Legs	\$34	ea.
CAS3	3" Locking Casters - Black	\$34	ea.
2FO	Two Fabric Option	\$131	per unit
GD1	Ratchet Ganging Device for Soft Seating	\$112	per pair
GD2	Flat Ganging Device for Soft Seating	\$112	per pair

GBP	Ganging Bracket for Plinth Base	\$286	per pair
COB	Clean Out Back-to-Back (1"-59"width)	\$654	per unit
CO1B	Clean Out Back-to-Back (60"and up)	\$1007	per unit
FMG	Floor Mount Glide	\$29	ea.
PBB	Plinth Base Back-To-Back (1"-59"width)	\$379	per unit
PBB60	Plinth Base Back-To-Back (60"and up)	\$575	per unit
UFB	Unfinished Plinth Base (deduct from plinth option)	Deduct \$80	
RB1	Recessed Base, 1 side	\$145	ea.
RB2	Recessed Base, 2 sides	\$287	ea.

DIMENSIONS	Straight Banquette
Seat Depth:	19.5"
Seat Height:	18"
Overall Depth:	27"
Overall Width:	48, 60, 72"
Overall Height:	42"
Qty./Wt.:	1 ea./150 lbs.



HIGH BACK BANQUETTE
48"W X 42"H

MODEL / DESCRIPTION / LIST PRICING

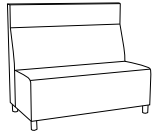

8372HB 48"W Straight High Back Banquette (4 legs)

COM Yardage: Total: 7.5 Yds. / Back: 4.5 Yds. / Seat: 3 Yds.

COM	GR1	GR2	GR3	GR4	GR5	GR6	GR7	GR8	GR9	GR10	LEA
\$4477	\$4790	\$4982	\$5181	\$5387	\$5604	\$5829	\$6062	\$6304	\$6557	\$6818	\$8060

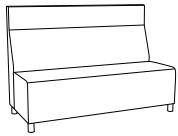

8374HB 60"W Straight High Back Banquette (4 legs)

COM Yardage: Total: 9.5 Yds. / Back: 5.5 Yds. / Seat: 4 Yds.

COM	GR1	GR2	GR3	GR4	GR5	GR6	GR7	GR8	GR9	GR10	LEA
\$5508	\$5894	\$6129	\$6375	\$6630	\$6893	\$7171	\$7459	\$7755	\$8064	\$8387	\$9915

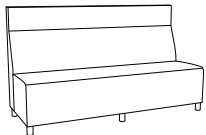

8376HB 72"W Straight High Back Banquette (6 legs)

COM Yardage: Total: 11.5 Yds. / Back: 6.5 Yds. / Seat: 5 Yds.

COM	GR1	GR2	GR3	GR4	GR5	GR6	GR7	GR8	GR9	GR10	LEA
\$6746	\$7207	\$7485	\$7776	\$8079	\$8394	\$8722	\$9061	\$9416	\$9783	\$10169	\$11978

Note: Clean out option is only available when units are facing the same direction.

Note: clean out options not available on plinth base units.

OPTIONS

Add upcharge to list price and code to model number

FR	CAL 133 (TB 133) Fire Retardant per yard	\$118	/yd.
MB	Moisture Barrier (1"-59"width)	\$164	ea.
MB60	Moisture Barrier (60"and up)	\$262	ea.
LOW	Fully Upholstered Low Back - 27" OA Height	\$124	per unit
WOD	Solid Maple Wood Legs	\$32	ea.
PC	Polished Chrome Legs	\$34	ea.
CAS3	3" Locking Casters - Black	\$34	ea.
2FO	Two Fabric Option	\$131	per unit
GD1	Ratchet Ganging Device for Soft Seating	\$112	per pair
GD2	Flat Ganging Device for Soft Seating	\$112	per pair

GBP	Ganging Bracket for Plinth Base	\$286	per pair
CO	Clean Out (1"-59"width)	\$327	per unit
CO1	Clean Out (60"and up)	\$503	per unit
FMG	Floor Mount Glide	\$29	ea.
PB	Plinth Base (1"-59"width)	\$247	per unit
PB60	Plinth Base (60"and up)	\$418	per unit
UFB	Unfinished Plinth Base (deduct from plinth option)	Deduct \$80	
RB1	Recessed Base, 1 side	\$145	ea.
RB2	Recessed Base, 2 sides	\$287	ea.

DIMENSIONS	Back-to-Back Banquette
Seat Depth:	19.5"
Seat Height:	18"
Overall Depth:	51.5"
Overall Width:	48, 60, 72"
Overall Height:	42"
Qty./Wt.:	1 ea./290 lbs.



HIGH BACK BACK-TO-BACK BANQUETTE
60"W X 42"H

MODEL / DESCRIPTION / LIST PRICING

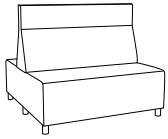

8380HB 48"W Back-to-Back High Back Banquette (6 legs)

COM Yardage: Total: 9 Yds. / Back: 4 Yds. / Seat: 5 Yds.

COM	GR1	GR2	GR3	GR4	GR5	GR6	GR7	GR8	GR9	GR10	LEA
\$8507	\$9102	\$9465	\$9846	\$10239	\$10649	\$11075	\$11517	\$11977	\$12457	\$12953	\$15314

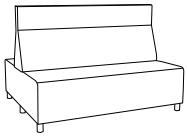

8382HB 60" W Back-to-Back High Back Banquette (6 legs)

COM Yardage: Total: 12 Yds. / Back: 6 Yds. / Seat: 6 Yds.

COM	GR1	GR2	GR3	GR4	GR5	GR6	GR7	GR8	GR9	GR10	LEA
\$10466	\$11198	\$11645	\$12114	\$12596	\$13101	\$13622	\$14170	\$14736	\$15322	\$15940	\$18838

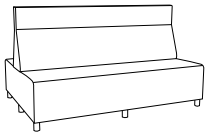

8384HB 72" W Back-to-Back High Back Banquette (8 legs)

COM Yardage: Total: 14 Yds. / Back: 7 Yds. / Seat: 7 Yds.

COM	GR1	GR2	GR3	GR4	GR5	GR6	GR7	GR8	GR9	GR10	LEA
\$12631	\$13500	\$14033	\$14587	\$15159	\$15759	\$16381	\$17027	\$17701	\$18398	\$19125	\$22567

Note: Clean out option is only available when units are facing the same direction.

Note: clean out options not available on plinth base units.

OPTIONS

Add upcharge to list price and code to model number

FR	CAL 133 (TB 133) Fire Retardant per yard	\$118	/yd.
MBB	Moisture Barrier Back-to-Back (1"-59"width)	\$327	ea.
MBB60	Moisture Barrier Back-to-Back (60"and up)	\$522	ea.
WOD	Solid Maple Wood Legs	\$32	ea.
PC	Polished Chrome Legs	\$34	ea.
CAS3	3" Locking Casters - Black	\$34	ea.
2FO	Two Fabric Option	\$131	per unit
GD1	Ratchet Ganging Device for Soft Seating	\$112	per pair
GD2	Flat Ganging Device for Soft Seating	\$112	per pair

GBP	Ganging Bracket for Plinth Base	\$286	per pair
COB	Clean Out Back-to-Back (1"-59"width)	\$654	per unit
C01B	Clean Out Back-to-Back (60"and up)	\$1007	per unit
FMG	Floor Mount Glide	\$29	ea.
PBB	Plinth Base Back-To-Back (1"-59"width)	\$379	per unit
PBB60	Plinth Base Back-To-Back (60"and up)	\$575	per unit
UFB	Unfinished Plinth Base (deduct from plinth option)	Deduct \$80	
RB1	Recessed Base, 1 side	\$145	ea.
RB2	Recessed Base, 2 sides	\$287	ea.

DIMENSIONS	Straight Banquette
Seat Depth:	19.5"
Seat Height:	18"
Overall Depth:	27"
Overall Width:	48, 60, 72"
Overall Height:	48"
Qty./Wt.:	1 ea./155 lbs.



HIGH BACK BANQUETTE
48"W X 48"H

MODEL / DESCRIPTION / LIST PRICING



8371HB 48"W Straight High Back Banquette (4 legs)

COM Yardage: Total: 8 Yds. / Back: 5 Yds. / Seat: 3 Yds.

COM	GR1	GR2	GR3	GR4	GR5	GR6	GR7	GR8	GR9	GR10	LEA
\$4675	\$4979	\$5163	\$5323	\$5547	\$5759	\$6036	\$6195	\$6379	\$6605	\$6842	\$8317

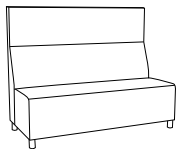

8373HB 60"W Straight High Back Banquette (4 legs)

COM Yardage: Total: 10 Yds. / Back: 6 Yds. / Seat: 4 Yds.

COM	GR1	GR2	GR3	GR4	GR5	GR6	GR7	GR8	GR9	GR10	LEA
\$5648	\$5952	\$6203	\$6455	\$6706	\$6956	\$7365	\$7524	\$7708	\$8066	\$8451	\$10189

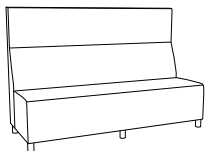

8375HB 72"W Straight High Back Banquette (6 legs)

COM Yardage: Total: 12.5 Yds. / Back: 7.5 Yds. / Seat: 5 Yds.

COM	GR1	GR2	GR3	GR4	GR5	GR6	GR7	GR8	GR9	GR10	LEA
\$6991	\$7347	\$7598	\$7922	\$8238	\$8490	\$8900	\$9189	\$9507	\$9864	\$10301	\$12433

Note: Clean out option is only available when units are facing the same direction.

Note: clean out options not available on plinth base units.

OPTIONS

Add upcharge to list price and code to model number

FR	CAL 133 (TB 133) Fire Retardant per yard	\$118	/yd.
MB	Moisture Barrier (1"-59"width)	\$164	ea.
MB60	Moisture Barrier (60"and up)	\$262	ea.
LOW	Fully Upholstered Low Back - 27" OA Height	\$124	per unit
WOD	Solid Maple Wood Legs	\$32	ea.
PC	Polished Chrome Legs	\$34	ea.
CAS3	3" Locking Casters - Black	\$34	ea.
2FO	Two Fabric Option	\$131	per unit
GD1	Ratchet Ganging Device for Soft Seating	\$112	per pair
GD2	Flat Ganging Device for Soft Seating	\$112	per pair

GBP	Ganging Bracket for Plinth Base	\$286	per pair
CO	Clean Out (1"-59"width)	\$327	per unit
CO1	Clean Out (60"and up)	\$503	per unit
FMG	Floor Mount Glide	\$29	ea.
PB	Plinth Base (1"-59"width)	\$247	per unit
PB60	Plinth Base (60"and up)	\$418	per unit
UFB	Unfinished Plinth Base (deduct from plinth option)	Deduct \$80	
RB1	Recessed Base, 1 side	\$145	ea.
RB2	Recessed Base, 2 sides	\$287	ea.

DIMENSIONS	Back-to-Back Banquette
Seat Depth:	19.5"
Seat Height:	18"
Overall Depth:	51.5"
Overall Width:	48, 60, 72"
Overall Height:	48"
Qty./Wt.:	1 ea./295 lbs.



HIGH BACK BACK-TO-BACK BANQUETTE
48"W X 48"H

MODEL / DESCRIPTION / LIST PRICING

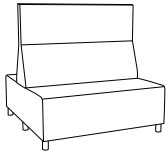

8381HB 48"W Back-to-Back High Back Banquette (6 legs)

COM Yardage: Total: 9.5 Yds. / Back: 4.5 Yds. / Seat: 5 Yds.

COM	GR1	GR2	GR3	GR4	GR5	GR6	GR7	GR8	GR9	GR10	LEA
\$8739	\$9176	\$9627	\$9916	\$10272	\$10657	\$11066	\$11621	\$12058	\$12679	\$13048	\$15844

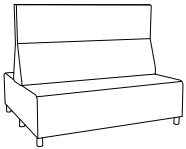

8383HB 60" W Back-to-Back High Back Banquette (6 legs)

COM Yardage: Total: 12.5 Yds. / Back: 6.5 Yds. / Seat: 6 Yds.

COM	GR1	GR2	GR3	GR4	GR5	GR6	GR7	GR8	GR9	GR10	LEA
\$10756	\$11324	\$11773	\$12196	\$12672	\$13186	\$13768	\$14322	\$14891	\$15513	\$16016	\$19073

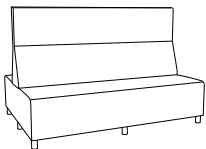

8387HB 72" W Back-to-Back High Back Banquette (8 legs)

COM Yardage: Total: 15 Yds. / Back: 8 Yds. / Seat: 7 Yds.

COM	GR1	GR2	GR3	GR4	GR5	GR6	GR7	GR8	GR9	GR10	LEA
\$12770	\$13602	\$14091	\$14646	\$15252	\$15901	\$16482	\$17171	\$17738	\$18491	\$19273	\$22729

Note: Clean out option is only available when units are facing the same direction.

Note: clean out options not available on plinth base units.

OPTIONS

Add upcharge to list price and code to model number

FR	CAL 133 (TB 133) Fire Retardant per yard	\$118	/yd.
MBB	Moisture Barrier Back-to-Back (1"-59"width)	\$327	ea.
MBB60	Moisture Barrier Back-to-Back (60"and up)	\$522	ea.
WOD	Solid Maple Wood Legs	\$32	ea.
PC	Polished Chrome Legs	\$34	ea.
CAS3	3" Locking Casters - Black	\$34	ea.
2FO	Two Fabric Option	\$131	per unit
GD1	Ratchet Ganging Device for Soft Seating	\$112	per pair
GD2	Flat Ganging Device for Soft Seating	\$112	per pair

GBP	Ganging Bracket for Plinth Base	\$286	per pair
COB	Clean Out Back-to-Back (1"-59"width)	\$654	per unit
C01B	Clean Out Back-to-Back (60"and up)	\$1007	per unit
FMG	Floor Mount Glide	\$29	ea.
PBB	Plinth Base Back-To-Back (1"-59"width)	\$379	per unit
PBB60	Plinth Base Back-To-Back (60"and up)	\$575	per unit
UFB	Unfinished Plinth Base (deduct from plinth option)	Deduct \$80	
RB1	Recessed Base, 1 side	\$145	ea.
RB2	Recessed Base, 2 sides	\$287	ea.

PRIVACY PANELS ONLY

DIMENSIONS	48" Wide Privacy Panel	60" Wide Privacy Panel	72" Wide Privacy Panel
Panel Depth:	1"	1"	1"
Panel Width:	48"	60"	72"
Panel Height:	48"	48"	48"



RAVEN BACK TO BACK BANQUETTE WITH PRIVACY PANEL



1/2" THICK ACRYLIC PRIVACY PANELS AVAILABLE

MODEL / DESCRIPTION / LIST PRICING

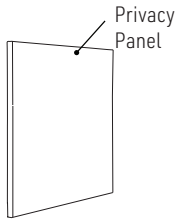

8372P 48" Wide Privacy Panel COM Yardage: Total: 3 Yds.

COM	GR1	GR2	GR3	GR4	GR5	GR6	GR7	GR8	GR9	GR10	LEA
\$1435	\$1536	\$1595	\$1661	\$1726	\$1796	\$1867	\$1941	\$2019	\$2100	\$2183	\$2580
LAMINATE			VENEER								
\$1405			\$2559								

8374P 60" Wide Privacy Panel COM Yardage: Total: 4 Yds.

COM	GR1	GR2	GR3	GR4	GR5	GR6	GR7	GR8	GR9	GR10	LEA
\$1892	\$2026	\$2104	\$2189	\$2277	\$2367	\$2459	\$2562	\$2663	\$2770	\$2881	\$3407
LAMINATE			VENEER								
\$1839			\$3291								

8376P 72" Wide Privacy Panel COM Yardage: Total: 5 Yds.

COM	GR1	GR2	GR3	GR4	GR5	GR6	GR7	GR8	GR9	GR10	LEA
\$2315	\$2478	\$2577	\$2682	\$2788	\$2899	\$3017	\$3137	\$3262	\$3391	\$3526	\$4170
LAMINATE			VENEER								
\$2233			\$3864								

Note for Edge of privacy panels:

- Straight panels: available with 3MM PVC or laminate self edge.
Select from any of our 3MM PVC edges in solid or wood tone, no custom colors available.
- Curved panels: will only be available with laminate self edge.
- Both straight and curved panels: when combining straights and curved, ONLY self edge is available.

Raven Modular Back Available in 2 heights 27" and 33"

OPTIONS

- CODE: FR - CAL 133 (TB 133) Fire Retardant
- CODE: MB - Moisture Barrier (1"-59"width)
- CODE: MB60 - Moisture Barrier (60"and up)
- CODE: LOW - Fully Upholstered Low Back - 27" OA Height
- CODE: WOD - Solid Maple Wood Legs with felt pads
- CODE: WAC - Wood Arm Caps
- CODE: PAC - Poly Arm Caps - Standard Black/Charcoal
- CODE: PC - Polished Chrome Legs
- CODE: CAS3 - 3" Locking Casters - Black
- CODE: CO - Clean Out (1"-59"width)
- CODE: CO1 - Clean Out (60"and up)
- CODE: 2FO - Two Fabric Option
- CODE: GD1 - Ratchet Ganging Device for Soft Seating
- CODE: GD2 - Flat Ganging Device for Soft Seating
- CODE: GD3 - Flat Ganging Device for Café & Training Tables
- CODE: TABFB-() - Fixed Blade Tablet
(outside or inside, specify (L/R), shape A, B or C)
- CODE: TABR1-() - Removable Swivel Tablet
(laminated shape A, B or C specify left or right arm)
- CODE: TABR2-() - Removable Swivel Tablet
(laminated shape A, B or C with opening for tablet on both arms)
- CODE: LAM5 - Non-standard laminate for 5 or less tablets
see options for upcharge
- CODE: SST - Solid Surface Tablet
- CODE: SS5 - Non-standard Solid Surface top for 5 or less tablets

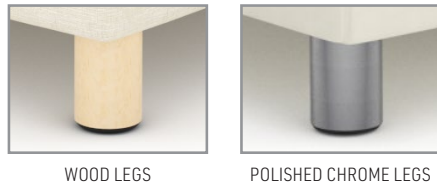

Note: Factory installed power/data available, see accessories online under the 'Products' tab.

Note: Legs with Floor Mount Glide and standard capped legs cannot be mixed/ganged together.

TABLET SHAPES

Three Tablet Shapes::

Choose from the three shapes shown and specify; A, B or C and left or right (outside tablet) when ordering.
Example: TABFB- (A) Left - this would be a fixed shape A tablet on the left side (when seated).

Laminated Top: Tops are 3/4"

- Tablet orders of 5 or less have 4 standard laminate colors:
- Wilsonart Black 1595-60
 - Wilsonart Montana Walnut 7110K-78
 - Formica Brite White 459-58
 - Nevamar Silver Alu Metalx MXT003
- Edge: 6F Multi-Ply

Solid Surface Top:

- Tablet orders of 5 or less have 4 standard Corian colors:
- Bone
 - Canyon
 - Glacier White
 - Silver Grey

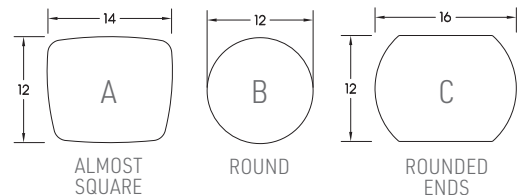

DIMENSIONS	22" Straight Unit	30" Straight Unit	44" Straight Unit
Seat Depth:	20"	20"	20"
Seat Height:	18"	18"	18"
Overall Depth:	27"	27"	27"
Overall Width:	22"	30"	44"
Overall Height:	33"	33"	33"
Qty./Wt.:	1 ea./44 lbs.	1 ea./44 lbs.	1 ea./44 lbs.



STRAIGHT UNITS - TABLET ARM AND ELECTRICAL OPTIONS

MODEL / DESCRIPTION / LIST PRICING

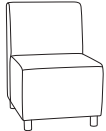

8302 22" W Straight Unit (4 legs)

COM Yardage: Total: 4 Yds. / Back: 2 Yds. / Seat: 2 Yds.

COM	GR1	GR2	GR3	GR4	GR5	GR6	GR7	GR8	GR9	GR10	LEA
\$1625	\$1744	\$1860	\$1996	\$2116	\$2247	\$2384	\$2518	\$2652	\$2788	\$2921	\$3117



8304 30" W Straight Unit (4 legs)

COM Yardage: Total: 5.25 Yds. / Back: 2.5 Yds. / Seat: 2.75 Yds.

COM	GR1	GR2	GR3	GR4	GR5	GR6	GR7	GR8	GR9	GR10	LEA
\$1754	\$1884	\$2020	\$2177	\$2317	\$2472	\$2628	\$2782	\$2937	\$3091	\$3279	\$3456

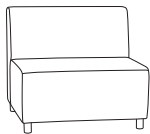

8306 44" W Straight Unit (4 legs)

COM Yardage: Total: 7 Yds. / Back: 4 Yds. / Seat: 3 Yds.

COM	GR1	GR2	GR3	GR4	GR5	GR6	GR7	GR8	GR9	GR10	LEA
\$2697	\$2899	\$3098	\$3300	\$3504	\$3706	\$3907	\$4110	\$4312	\$4511	\$4717	\$4910

Note: Clean out option is only available when units are facing the same direction.

OPTIONS

Add upcharge to list price and code to model number

FR	CAL 133 (TB 133) Fire Retardant per yard	\$118	/yd.
MB	Moisture Barrier (1"-59"width)	\$164	ea.
LOW	Fully Upholstered Low Back - 27" OA Height	\$124	
WOD	Solid Maple Wood Legs	\$32	ea.
PC	Polished Chrome Legs	\$34	ea.
CAS3	3" Locking Casters - Black	\$34	ea.
2FO	Two Fabric Option	\$131	per unit

GD1	Ratchet Ganging Device for Soft Seating	\$112	per pair
GD2	Flat Ganging Device for Soft Seating	\$112	per pair
TABFB-()	Fixed Blade Tablet (outside or inside, specify (L/R), shape A, B or C)	\$593	ea. tablet
LAM5	Non-standard laminate (5 tablets or less)	\$554	ea. tablet
SST	Solid Surface Tablet Arm - add to tablet option	\$271	ea. tablet
SS5	Non-standard Solid Surface (5 tablets or less)	Call For Quote	
CO	Clean Out (1"-59"width)	\$327	

DIMENSIONS	30° Curve Inside	45° Curve Inside	60° Curve Inside
Seat Depth:	20"	20"	20"
Seat Height:	18"	18"	18"
Overall Depth:	29"	30.5"	32.5"
Overall Width:	35"	52"	67"
Overall Height:	33"	33"	33"
Qty./Wt.:	1 ea./64 lbs.	1 ea./84 lbs.	1 ea./115 lbs.



60° INSIDE CURVE WITH OPTIONAL POWER/
DATA UNIT

MODEL / DESCRIPTION / LIST PRICING

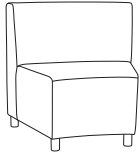

8308 Inside 30° Curve Unit (4 legs)

COM Yardage: Total: 5.25 Yds. / Back: 2.75 Yds. / Seat: 2.5 Yds.

COM	GR1	GR2	GR3	GR4	GR5	GR6	GR7	GR8	GR9	GR10	LEA
\$1768	\$1886	\$2006	\$2139	\$2257	\$2388	\$2524	\$2657	\$2794	\$2928	\$3064	\$3260

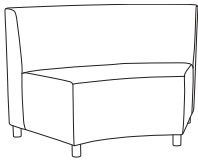

8310 Inside 45° Curve Unit (4 legs)

COM Yardage: Total: 6 Yds. / Back: 3 Yds. / Seat: 3 Yds.

COM	GR1	GR2	GR3	GR4	GR5	GR6	GR7	GR8	GR9	GR10	LEA
\$2596	\$2764	\$2936	\$3121	\$3289	\$3473	\$3657	\$3844	\$4028	\$4214	\$4399	\$4592

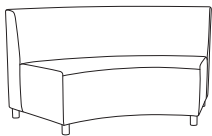

8318 Inside 60° Curve Unit (5 legs)

COM Yardage: Total: 9 Yds. / Back: 5 Yds. / Seat: 4 Yds.

COM	GR1	GR2	GR3	GR4	GR5	GR6	GR7	GR8	GR9	GR10	LEA
\$3378	\$3545	\$3712	\$3900	\$4065	\$4253	\$4437	\$4622	\$4807	\$4992	\$5179	\$5373

Note: Clean out option is only available when units are facing the same direction.

OPTIONS

Add upcharge to list price and code to model number

FR	CAL 133 (TB 133) Fire Retardant per yard	\$118	/yd.
MB	Moisture Barrier (1"-59"width)	\$164	ea.
MB60	Moisture Barrier (60"and up)	\$262	ea.
LOW	Fully Upholstered Low Back - 27" OA Height	\$124	
WOD	Solid Maple Wood Legs	\$32	ea.
PC	Polished Chrome Legs	\$34	ea.
CAS3	3" Locking Casters - Black	\$34	ea.
2FO	Two Fabric Option	\$131	per unit

GD1	Ratchet Ganging Device for Soft Seating	\$112	per pair
GD2	Flat Ganging Device for Soft Seating	\$112	per pair
TABFB-()	Fixed Blade Tablet (outside or inside, specify (L/R), shape A, B or C)	\$593	ea. tablet
LAM5	Non-standard laminate (5 tablets or less)	\$554	ea. tablet
SST	Solid Surface Tablet Arm - add to tablet option	\$271	ea. tablet
SS5	Non-standard Solid Surface (5 tablets or less)	Call For Quote	
CO	Clean Out (1"-59"width)	\$327	
CO1	Clean Out (60"and up)	\$503	

DIMENSIONS	20° Curve Outside	30° Curve Outside	45° Curve Outside	60° Curve Outside
Seat Depth:	20"	20"	20"	20"
Seat Height:	18"	18"	18"	18"
Overall Depth:	27"	29"	30.5"	32.5"
Overall Width:	23"	35"	52"	67"
Overall Height:	33"	33"	33"	33"
Qty./Wt.:	1 ea./44 lbs.	1 ea./64 lbs.	1 ea./85 lbs.	1 ea./110 lbs.



60 DEGREE OUTSIDE CURVE

MODEL / DESCRIPTION / LIST PRICING

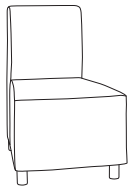

8312 Outside 20° Curve Unit (4 legs)

COM Yardage: Total: 4.5 Yds. / Back: 2 Yds. / Seat: 2.5 Yds.

COM	GR1	GR2	GR3	GR4	GR5	GR6	GR7	GR8	GR9	GR10	LEA
\$1847	\$1981	\$2099	\$2233	\$2352	\$2488	\$2619	\$2757	\$2891	\$3025	\$3159	\$3353

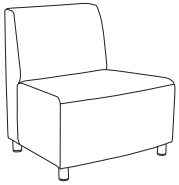

8314 Outside 30° Curve Unit (4 legs)

COM Yardage: Total: 5 Yds. / Back: 2 Yds. / Seat: 3 Yds.

COM	GR1	GR2	GR3	GR4	GR5	GR6	GR7	GR8	GR9	GR10	LEA
\$1977	\$2109	\$2228	\$2362	\$2479	\$2615	\$2748	\$2884	\$3019	\$3152	\$3289	\$3479

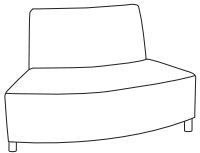

8316 Outside 45° Curve Unit (4 legs)

COM Yardage: Total: 7 Yds. / Back: 3 Yds. / Seat: 4 Yds.

COM	GR1	GR2	GR3	GR4	GR5	GR6	GR7	GR8	GR9	GR10	LEA
\$2901	\$3069	\$3240	\$3424	\$3593	\$3777	\$3963	\$4148	\$4332	\$4519	\$4702	\$4895

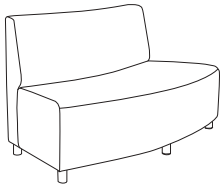

8320 Outside 60° Curve Unit (5 legs)

COM Yardage: Total: 8 Yds. / Back: 3.5 Yds. / Seat: 4.5 Yds.

COM	GR1	GR2	GR3	GR4	GR5	GR6	GR7	GR8	GR9	GR10	LEA
\$3670	\$3855	\$4024	\$4210	\$4378	\$4561	\$4748	\$4932	\$5120	\$5303	\$5489	\$5683

Note: Clean out option is only available when units are facing the same direction.

OPTIONS

Add upcharge to list price and code to model number

FR	CAL 133 (TB 133) Fire Retardant per yard	\$118	/yd.
MB	Moisture Barrier (1"-59"width)	\$164	ea.
MB60	Moisture Barrier (60"and up)	\$262	ea.
LOW	Fully Upholstered Low Back - 27" OA Height	\$124	
WOD	Solid Maple Wood Legs	\$32	ea.
PC	Polished Chrome Legs	\$34	ea.
CAS3	3" Locking Casters - Black	\$34	ea.
2FO	Two Fabric Option	\$131	per unit

GD1	Ratchet Ganging Device for Soft Seating	\$112	per pair
GD2	Flat Ganging Device for Soft Seating	\$112	per pair
TABFB-()	Fixed Blade Tablet (outside or inside, specify (L/R), shape A, B or C)	\$593	ea. tablet
LAM5	Non-standard laminate (5 tablets or less)	\$554	ea. tablet
SST	Solid Surface Tablet Arm - add to tablet option	\$271	ea. tablet
SS5	Non-standard Solid Surface (5 tablets or less)	Call For Quote	
CO	Clean Out (1"-59"width)	\$327	
CO1	Clean Out (60"and up)	\$503	

DIMENSIONS	Corner Square Seat	Corner Curved Seat	Corner Curved Back Panel
Seat Depth:	21"	21"	21"
Seat Height:	18"	18"	18"
Overall Depth:	28"	28"	28"
Overall Width:	28"	28"	28"
Overall Height:	33"	33"	33"
Qty./Wt.:	1 ea./75 lbs.	1 ea./75 lbs.	1 ea./75 lbs.



CORNER UNIT - SQUARE SEAT



CORNER UNIT - CURVE SEAT



CORNER UNIT - CURVE BACK

MODEL / DESCRIPTION / LIST PRICING



8386 Corner Unit - **Square Seat** (4 legs)

COM Yardage: Total: 6.5 Yds. / Back: 4.5 Yds. / Seat: 2 Yds.

COM	GR1	GR2	GR3	GR4	GR5	GR6	GR7	GR8	GR9	GR10	LEA
\$3129	\$3346	\$3480	\$3619	\$3763	\$3916	\$4070	\$4235	\$4405	\$4580	\$4763	\$5630



8388 Corner Unit - **Curved Seat** (4 legs)

COM Yardage: Total: 6.5 Yds. / Back: 4.5 Yds. / Seat: 2 Yds.

COM	GR1	GR2	GR3	GR4	GR5	GR6	GR7	GR8	GR9	GR10	LEA
\$3402	\$3631	\$3769	\$3915	\$4064	\$4223	\$4385	\$4555	\$4733	\$4916	\$5108	\$6013



8389 Corner Unit - **Curved Back Panel** (4 legs)

COM Yardage: Total: 6.5 Yds. / Back: 4.5 Yds. / Seat: 2 Yds.

COM	GR1	GR2	GR3	GR4	GR5	GR6	GR7	GR8	GR9	GR10	LEA
\$3716	\$3964	\$4111	\$4270	\$4433	\$4600	\$4774	\$4961	\$5148	\$5346	\$5553	\$6522

Note: Clean out option is only available when units are facing the same direction.

OPTIONS

Add upcharge to list price and code to model number

FR	CAL 133 (TB 133) Fire Retardant per yard	\$118	/yd.
MB	Moisture Barrier (1"-59"width)	\$164	ea.
MB60	Moisture Barrier (60"and up)	\$262	ea.
LOW	Fully Upholstered Low Back - 27" OA Height	\$124	
WOD	Solid Maple Wood Legs	\$32	ea.
PC	Polished Chrome Legs	\$34	ea.

CAS3	3" Locking Casters - Black	\$34	ea.
2FO	Two Fabric Option	\$131	
GD1	Ganging Device for Metal/Wood Legs	\$112	
GD2	Flat Ganging Device for Soft Seating	\$112	
CO	Clean Out (1"-59"width)	\$327	
CO1	Clean Out (60"and up)	\$503	

DIMENSIONS	Straight Unit	Straight Unit	Straight Unit
Panel Depth:	1"	1"	1"
Overall Width:	22"	30"	44"
Overall Height:	48"	48"	48"
Qty./Approx Wt.:	1 ea./100 lbs.	1 ea./110 lbs.	1 ea./120 lbs.

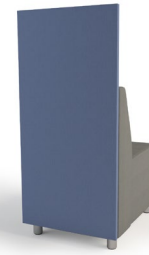

STRAIGHT UNIT

MODEL / DESCRIPTION / LIST PRICING

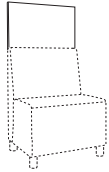

8302P/U	22"W Straight Unit											COM Yardage: 1.5 Yds.
COM	GR1	GR2	GR3	GR4	GR5	GR6	GR7	GR8	GR9	GR10	LEA	
\$976	\$1047	\$1085	\$1130	\$1177	\$1222	\$1269	\$1321	\$1374	\$1430	\$1486	\$1757	

8302P/L	Laminate
Laminate	\$1197

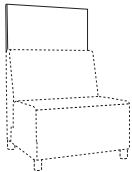

8403P/U	27"W Straight Unit											COM Yardage: 1.5 Yds.
COM	GR1	GR2	GR3	GR4	GR5	GR6	GR7	GR8	GR9	GR10	LEA	
\$1123	\$1204	\$1250	\$1300	\$1354	\$1403	\$1459	\$1520	\$1582	\$1644	\$1710	\$2020	

8403P/L	Laminate
Laminate	\$1376

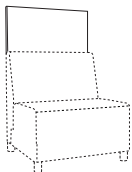

8304P/U	30"W Straight Unit											COM Yardage: 2 Yds.
COM	GR1	GR2	GR3	GR4	GR5	GR6	GR7	GR8	GR9	GR10	LEA	
\$1209	\$1296	\$1344	\$1398	\$1455	\$1515	\$1575	\$1637	\$1703	\$1774	\$1844	\$2178	

8304P/L	Laminate
Laminate	\$1452

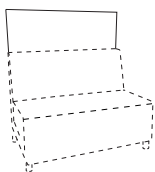

8306P/U	44"W Straight Unit											COM Yardage: 3 Yds.
COM	GR1	GR2	GR3	GR4	GR5	GR6	GR7	GR8	GR9	GR10	LEA	
\$1391	\$1487	\$1542	\$1610	\$1671	\$1739	\$1808	\$1882	\$1959	\$2035	\$2118	\$2503	

8306P/L	Laminate
Laminate	\$1672

Note for Edge of privacy panels:

- Straight panels: available with 3MM PVC or laminate self edge.
Select from any of our 3MM PVC edges in solid or wood tone, no custom colors available.
- Curved panels: will only able available with laminate self edge.
- Both straight and curved panels: when combining straights and curved, ONLY self edge is available.

OPTIONS

Add upcharge to list price and code to model number

FR	CAL 133 (TB 133) Fire Retardant per yard	\$118	/yd.
----	--	-------	------

2FO	Two Fabric Option	\$131	
-----	-------------------	-------	--

DIMENSIONS	30° Curve Inside	45° Curve Inside	60° Curve Inside
Panel Depth:	1"	1"	1"
Overall Width:	35"	52"	67"
Overall Height:	48"	48"	48"
Qty./Approx Wt.:	1 ea./135 lbs.	1 ea./145 lbs.	1 ea./160 lbs.

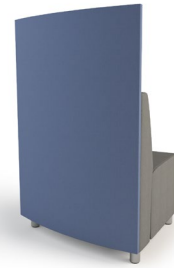

INSIDE CURVE UNIT

MODEL / DESCRIPTION / LIST PRICING

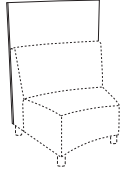

8308P/U Inside 30° Curve Unit COM Yardage: 2 Yds.

COM	GR1	GR2	GR3	GR4	GR5	GR6	GR7	GR8	GR9	GR10	LEA
\$1812	\$1939	\$2018	\$2097	\$2180	\$2266	\$2360	\$2453	\$2551	\$2654	\$2760	\$3262

8308P/L Laminate

Laminate
\$2375

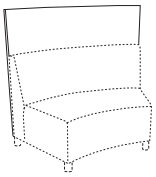

8310P/U Inside 45° Curve Unit COM Yardage: 3 Yds.

COM	GR1	GR2	GR3	GR4	GR5	GR6	GR7	GR8	GR9	GR10	LEA
\$2085	\$2230	\$2321	\$2414	\$2507	\$2609	\$2715	\$2823	\$2933	\$3052	\$3173	\$3751

8310P/L Laminate

Laminate
\$2731

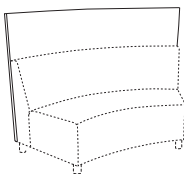

8318P/U Inside 60° Curve Unit COM Yardage: 4 Yds.

COM	GR1	GR2	GR3	GR4	GR5	GR6	GR7	GR8	GR9	GR10	LEA
\$3254	\$3482	\$3622	\$3767	\$3915	\$4075	\$4235	\$4404	\$4580	\$4765	\$4953	\$5858

8318P/L Laminate

Laminate
\$4257

Note for Edge of privacy panels:

- Straight panels: available with 3MM PVC or laminate self edge.
Select from any of our 3MM PVC edges in solid or wood tone, no custom colors available.
- Curved panels: will only be available with laminate self edge.
- Both straight and curved panels: when combining straights and curved, ONLY self edge is available.

OPTIONS

Add upcharge to list price and code to model number

FR	CAL 133 (TB 133) Fire Retardant per yard	\$118	/yd.
----	--	-------	------

2FO	Two Fabric Option	\$131	
-----	-------------------	-------	--

DIMENSIONS	20° Curve Outside	30° Curve Outside	45° Curve Outside	60° Curve Outside
Panel Depth:	1"	1"	1"	1"
Overall Width:	22"	35"	52"	67"
Overall Height:	48"	48"	48"	48"
Qty./Approx Wt.:	1 ea./120 lbs.	1 ea./135 lbs.	1 ea./145 lbs.	1 ea./160 lbs.



OUTSIDE CURVE UNIT

MODEL / DESCRIPTION / LIST PRICING

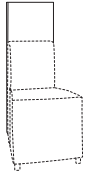

8312P/U Outside 20° Curve Unit COM Yardage: 1.5 Yds.

COM	GR1	GR2	GR3	GR4	GR5	GR6	GR7	GR8	GR9	GR10	LEA
\$1268	\$1358	\$1411	\$1467	\$1523	\$1588	\$1650	\$1717	\$1782	\$1855	\$1931	\$2282

8312P/L Laminate

Laminate
\$1806

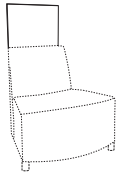

8314P/U Outside 30° Curve Unit COM Yardage: 2 Yds.

COM	GR1	GR2	GR3	GR4	GR5	GR6	GR7	GR8	GR9	GR10	LEA
\$1812	\$1939	\$2018	\$2097	\$2180	\$2266	\$2360	\$2453	\$2551	\$2654	\$2760	\$3262

8314P/L Laminate

Laminate
\$2521

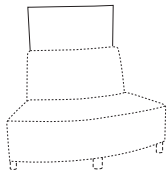

8316P/U Outside 45° Curve Unit COM Yardage: 2 Yds.

COM	GR1	GR2	GR3	GR4	GR5	GR6	GR7	GR8	GR9	GR10	LEA
\$2085	\$2230	\$2321	\$2414	\$2507	\$2609	\$2715	\$2823	\$2933	\$3052	\$3173	\$3751

8316P/L Laminate

Laminate
\$2876

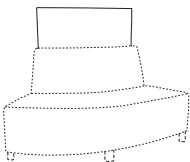

8320P/U Outside 60° Curve Unit COM Yardage: 3 Yds.

COM	GR1	GR2	GR3	GR4	GR5	GR6	GR7	GR8	GR9	GR10	LEA
\$3254	\$3482	\$3622	\$3767	\$3915	\$4075	\$4235	\$4404	\$4580	\$4765	\$4953	\$5858

8320P/L Laminate

Laminate
\$4401

Note for Edge of privacy panels:

- Straight panels: available with 3MM PVC or laminate self edge. Select from any of our 3MM PVC edges in solid or wood tone, no custom colors available.
- Curved panels: will only be available with laminate self edge.
- Both straight and curved panels: when combining straights and curved, ONLY self edge is available.

OPTIONS

Add upcharge to list price and code to model number

FR	CAL 133 (TB 133) Fire Retardant per yard	\$118	/yd.
----	--	-------	------

2FO	Two Fabric Option	\$128	
-----	-------------------	-------	--

DIMENSIONS	Straight Backless	Bariatric Backless
Seat Depth:	27"	27"
Seat Height:	18"	18"
Overall Depth:	27"	27"
Overall Width:	22", 44"	30"
Overall Height:	18"	18"
Qty./Wt.:	1 ea./40/60 lbs.	1 ea./80 lbs.



SINGLE SEAT BACKLESS WITH OPTIONAL TWO FABRIC

MODEL / DESCRIPTION / LIST PRICING

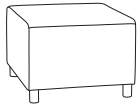

8326 Single Seat Backless Unit 22"

COM Yardage: Total: 2.5 Yds. / Sides: 1.5 Yds. / Top: 1 Yds.

COM	GR1	GR2	GR3	GR4	GR5	GR6	GR7	GR8	GR9	GR10	LEA
\$1421	\$1544	\$1664	\$1803	\$1923	\$2063	\$2203	\$2339	\$2479	\$2617	\$2758	\$2957

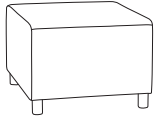

8328 Bariatric Backless Unit 30"

COM Yardage: Total: 3 Yds. / Sides: 2 Yds. / Top: 1 Yds.

COM	GR1	GR2	GR3	GR4	GR5	GR6	GR7	GR8	GR9	GR10	LEA
\$1634	\$1823	\$2017	\$2209	\$2400	\$2591	\$2782	\$2971	\$3165	\$3355	\$3546	\$3732



8330 Two Seat Backless Unit 44"

COM Yardage: Total: 4 Yds. / Sides: 2.5 Yds. / Top: 1.5 Yds.

COM	GR1	GR2	GR3	GR4	GR5	GR6	GR7	GR8	GR9	GR10	LEA
\$2567	\$2774	\$2984	\$3192	\$3400	\$3610	\$3815	\$4024	\$4232	\$4440	\$4649	\$4848

OPTIONS

Add upcharge to list price and code to model number

FR	CAL 133 (TB 133) Fire Retardant per yard	\$118	/yd.	GD1	Ratchet Ganging Device for Soft Seating	\$112	per pair
MB	Moisture Barrier (1"-59"width)	\$164	ea.	GD2	Flat Ganging Device for Soft Seating	\$112	per pair
WOD	Solid Maple Wood Legs	\$32	ea.	TABFB-()	Fixed Blade Tablet (outside or inside, specify (L/R), shape A, B or C)	\$593	ea. tablet
PC	Polished Chrome Legs	\$34	ea.	LAM5	Non-standard laminate (5 tablets or less)	\$554	ea. tablet
CAS3	3" Locking Casters - Black	\$34	ea.	SST	Solid Surface Tablet Arm - add to tablet option	\$271	ea. tablet
2FO	Two Fabric Option	\$131	per unit	SS5	Non-standard Solid Surface (5 tablets or less)	Call For Quote	

DIMENSIONS	20° Curve Backless	30° Curve Backless	45° Curve Backless	60° Curve Backless
Seat Depth:	27"	27"	27"	27"
Seat Height:	18"	18"	18"	18"
Overall Depth:	28"	29"	30.5"	32.5"
Overall Width:	32"	35"	52"	67"
Overall Height:	18"	18"	18"	18"
Qty./Wt.:	1 ea./42 lbs.	1 ea./62 lbs.	1 ea./82 lbs.	1 ea./102 lbs.



60° CURVE BACKLESS UNIT

MODEL / DESCRIPTION / LIST PRICING

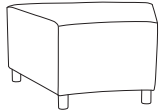

8332 20° Curve Unit (4 legs)

COM Yardage: Total: 2.75 Yds. / Sides: 1.75 Yds. / Top: 1 Yds.

COM	GR1	GR2	GR3	GR4	GR5	GR6	GR7	GR8	GR9	GR10	LEA
\$1592	\$1714	\$1836	\$1977	\$2098	\$2236	\$2374	\$2512	\$2651	\$2791	\$2928	\$3127

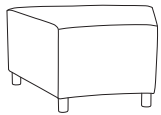

8334 30° Curve Unit (4 legs)

COM Yardage: Total: 3.5 Yds. / Sides: 2 Yds. / Top: 1.5 Yds.

COM	GR1	GR2	GR3	GR4	GR5	GR6	GR7	GR8	GR9	GR10	LEA
\$1711	\$1833	\$1954	\$2091	\$2213	\$2353	\$2493	\$2632	\$2768	\$2909	\$3048	\$3246

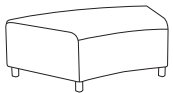

8336 45° Curve Unit (4 legs)

COM Yardage: Total: 5 Yds. / Sides: 3.25 Yds. / Top: 1.75 Yds.

COM	GR1	GR2	GR3	GR4	GR5	GR6	GR7	GR8	GR9	GR10	LEA
\$2380	\$2499	\$2619	\$2761	\$2881	\$3021	\$3158	\$3297	\$3438	\$3575	\$3714	\$3915

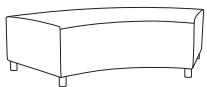

8338 60° Curve Unit (5 legs)

COM Yardage: Total: 5.5 Yds. / Sides: 3 Yds. / Top: 2.5 Yds.

COM	GR1	GR2	GR3	GR4	GR5	GR6	GR7	GR8	GR9	GR10	LEA
\$2909	\$3028	\$3150	\$3290	\$3409	\$3549	\$3687	\$3827	\$3965	\$4103	\$4241	\$4441

OPTIONS

Add upcharge to list price and code to model number

FR	CAL 133 (TB 133) Fire Retardant per yard	\$118	/yd.
MB	Moisture Barrier (1"-59"width)	\$164	ea.
MB60	Moisture Barrier (60"and up)	\$262	ea.
WOD	Solid Maple Wood Legs	\$32	ea.
PC	Polished Chrome Legs	\$34	ea.
CAS3	3" Locking Casters - Black	\$34	ea.
2FO	Two Fabric Option	\$131	per unit

GD1	Ratchet Ganging Device for Soft Seating	\$112	per pair
GD2	Flat Ganging Device for Soft Seating	\$112	per pair
TABFB-()	Fixed Blade Tablet (outside or inside, specify (L/R), shape A, B or C)	\$593	ea. tablet
LAM5	Non-standard laminate (5 tablets or less)	\$554	ea. tablet
SST	Solid Surface Tablet Arm - add to tablet option	\$271	ea. tablet
SS5	Non-standard Solid Surface (5 tablets or less)	Call For Quote	



SINGLE SEAT WITH ARMS

DIMENSIONS	R-L Arm	Center Arm
Overall Depth:	27"	19"
Overall Width:	3"	2"
Overall Height:	25"	21"
Qty./Wt.:	1 ea./25 lbs.	1 ea./10 lbs.

MODEL / DESCRIPTION / LIST PRICING

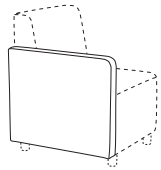

8358L/R Left or Right Arm

COM Yardage: 1.5 Yds..

COM	GR1	GR2	GR3	GR4	GR5	GR6	GR7	GR8	GR9	GR10	LEA
\$411	\$491	\$552	\$633	\$690	\$748	\$808	\$869	\$949	\$1025	\$1105	\$1285

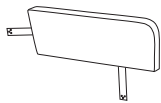

8358C Center Arm (ARM CAP NOT AVAILABLE)

COM Yardage: .75 Yds..

COM	GR1	GR2	GR3	GR4	GR5	GR6	GR7	GR8	GR9	GR10	LEA
\$400	\$481	\$537	\$616	\$675	\$738	\$798	\$855	\$936	\$1014	\$1095	\$1271

Note: Tablet options available on full left or right arm only and cannot be used with arm caps.

OPTIONS

Add upcharge to list price and code to model number

FR	CAL 133 (TB 133) Fire Retardant per yard	\$118	/yd.	SST	Solid Surface Tablet Arm - add to tablet option	\$271	ea. tablet
TAB-()	Swivel Tablet (specify A, B or C, left or right arm)	\$653	ea. tablet	SS5	Non-standard Solid Surface (5 tablets or less)	Call For Quote	
TABR1-()	Removable Tablet (specify A, B or C, left or right arm)	\$756	ea. tablet	WAC	Single Wood Arm Cap	\$116	
TABR2-()	Removable Tablet (specify A, B or C both arm openings)	\$893	ea. tablet	PAC	Poly Arm Cap - Standard Black/Charcoal	\$89	ea.
LAM5	Non-standard laminate (5 tablets or less)	\$554	ea. tablet				



"S" CONFIGURATION: SIX 60° CURVE UNITS, TWO 60° BACKLESS CURVE UNITS WITH CABANA OCCASIONAL TABLES

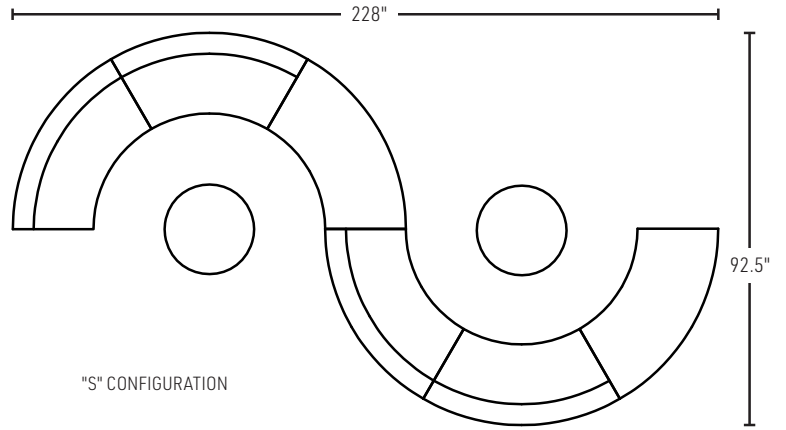

"S" CONFIGURATION



THREE 60° CURVE UNITS, TWO OUTSIDE ARMS, TWO LOUNGE UNITS AND 36" ROUND CABANA TABLE WITH COVE POWER OPTION

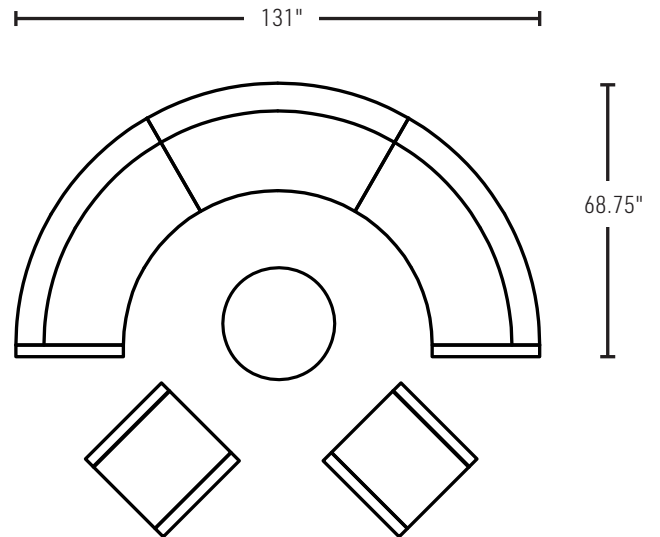

ARC CONFIGURATION



SERPENTINE CONFIGURATION

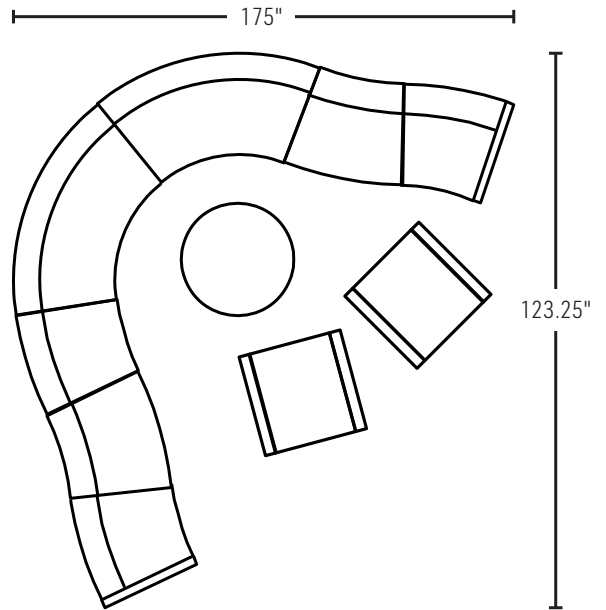

"L" SHAPE CONFIGURATION

ONE CORNER UNIT, SIX STRAIGHT UNITS,, TWO OUTSIDE ARMS, TWO LOUNGE UNITS AND TWO CABANA OCCASIONAL TABLES FEATURING COVE POWER OPTION

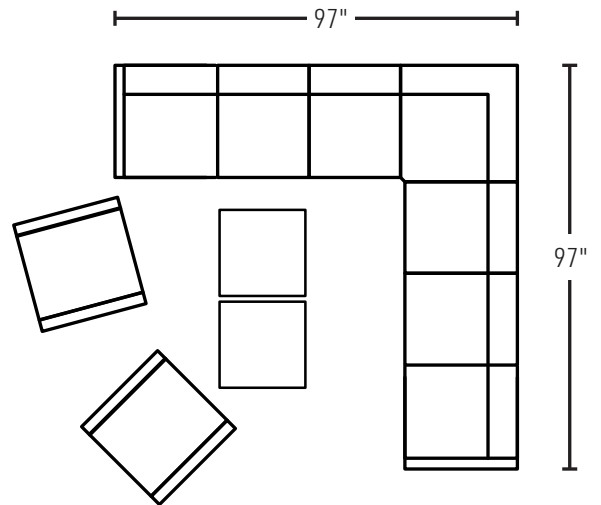

DIMENSIONS	18" Round	24" Round	30" Round	36" Round	42" Round
Overall Depth:	18"	24"	30"	36"	42"
Overall Width:	18"	24"	30"	36"	42"
Overall Height:	16" or 18"	18"	18"	18"	18"
Qty./Wt.:	1 ea./26 lbs.	1 ea./37 lbs.	1 ea./48 lbs.	1 ea./68 lbs.	1 ea./84 lbs.



36" ROUND OTTOMAN

MODEL / DESCRIPTION / LIST PRICING

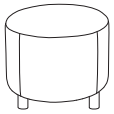

8341-S 18" Round Ottoman - **16" height** (4 legs) (4 - 2" Casters Needed) COM Yardage: Total: 2.75 Yds. / Sides: 2 Yds. / Top: .75 Yds.

COM	GR1	GR2	GR3	GR4	GR5	GR6	GR7	GR8	GR9	GR10	LEA
\$1325	\$1389	\$1441	\$1505	\$1569	\$1633	\$1712	\$1788	\$1865	\$1968	\$2070	\$2390

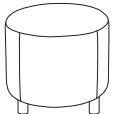

8341 18" Round Ottoman (4 legs) (4 - 2" Casters Needed) COM Yardage: Total: 2.75 Yds. / Sides: 2 Yds. / Top: .75 Yds.

COM	GR1	GR2	GR3	GR4	GR5	GR6	GR7	GR8	GR9	GR10	LEA
\$1357	\$1421	\$1476	\$1539	\$1604	\$1667	\$1744	\$1821	\$1900	\$2001	\$2104	\$2424

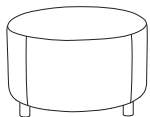

8339 24" Round Ottoman (4 legs) (4 Casters Needed) COM Yardage: Total: 2.75 Yds. / Sides: 2 Yds. / Top: .75 Yds.

COM	GR1	GR2	GR3	GR4	GR5	GR6	GR7	GR8	GR9	GR10	LEA
\$1678	\$1887	\$2095	\$2302	\$2510	\$2718	\$2927	\$3134	\$3343	\$3550	\$3759	\$3959

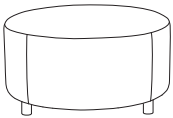

8340 30" Round Ottoman (4 legs) (4 Casters Needed) COM Yardage: Total: 3.5 Yds. / Sides: 2.5 Yds. / Top: 1 Yds.

COM	GR1	GR2	GR3	GR4	GR5	GR6	GR7	GR8	GR9	GR10	LEA
\$2307	\$2515	\$2724	\$2935	\$3141	\$3346	\$3555	\$3763	\$3972	\$4180	\$4386	\$4589

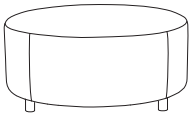

8342 36" Round Ottoman (4 legs) (4 Casters Needed) COM Yardage: Total: 4.25 Yds. / Sides: 2.75 Yds. / Top: 1.25 Yds.

COM	GR1	GR2	GR3	GR4	GR5	GR6	GR7	GR8	GR9	GR10	LEA
\$2774	\$2984	\$3192	\$3400	\$3610	\$3815	\$4024	\$4232	\$4440	\$4649	\$4856	\$5057

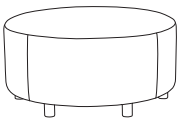

8344 42" Round Ottoman (6 legs) (6 Casters Needed) COM Yardage: Total: 4.5 Yds. / Sides: 2.75 Yds. / Top: 1.25 Yds.

COM	GR1	GR2	GR3	GR4	GR5	GR6	GR7	GR8	GR9	GR10	LEA
\$2998	\$3208	\$3416	\$3621	\$3831	\$4040	\$4247	\$4453	\$4664	\$4874	\$5080	\$5278

OPTIONS

Add upcharge to list price and code to model number

FR	CAL 133 (TB 133) Fire Retardant per yard	\$118	/yd.
MB	Moisture Barrier (1"-59"width)	\$164	ea.
WOD	Solid Maple Wood Legs	\$32	ea.
PC	Polished Chrome Legs	\$34	ea.

CAS2	2" Locking Casters - Black (18" size Only)	\$28	ea.
CAS3	3" Locking Casters - Black (not available on 18" size)	\$34	ea.
2FO	Two Fabric Option	\$131	

DIMENSIONS	18" Round	24" Round	30" Round	36" Round	42" Round
Overall Depth:	18"	24"	30"	36"	42"
Overall Width:	18"	24"	30"	36"	42"
Overall Height:	16" or 18"	18"	18"	18"	18"
Qty./Wt.:	1 ea./26 lbs.	1 ea./37 lbs.	1 ea./48 lbs.	1 ea./68 lbs.	1 ea./84 lbs.



ROUND OTTOMAN / NO LEGS
W/ PLASTIC GLIDES

MODEL / DESCRIPTION / LIST PRICING

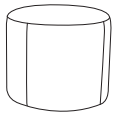

8341-NLS 18" Round Ottoman - **16" height** / No Legs

COM Yardage: Total: 2.75 Yds. / Sides: 2 Yds. / Top: .75 Yds.

COM	GR1	GR2	GR3	GR4	GR5	GR6	GR7	GR8	GR9	GR10	LEA
\$1262	\$1327	\$1381	\$1445	\$1509	\$1574	\$1650	\$1727	\$1804	\$1907	\$2009	\$2330

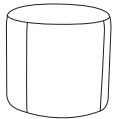

8341-NL 18" Round Ottoman / No Legs

COM Yardage: Total: 2.75 Yds. / Sides: 2 Yds. / Top: .75 Yds.

COM	GR1	GR2	GR3	GR4	GR5	GR6	GR7	GR8	GR9	GR10	LEA
\$1268	\$1441	\$1612	\$1786	\$1962	\$2131	\$2304	\$2475	\$2650	\$2823	\$2995	\$3160

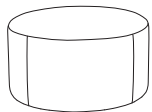

8339-NL 24" Round Ottoman / No Legs

COM Yardage: Total: 2.75 Yds. / Sides: 2 Yds. / Top: .75 Yds.

COM	GR1	GR2	GR3	GR4	GR5	GR6	GR7	GR8	GR9	GR10	LEA
\$1556	\$1741	\$1922	\$2106	\$2291	\$2472	\$2654	\$2837	\$3021	\$3204	\$3388	\$3564

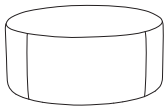

8340-NL 30" Round Ottoman / No Legs

COM Yardage: Total: 3.5 Yds. / Sides: 2.5 Yds. / Top: 1 Yds.

COM	GR1	GR2	GR3	GR4	GR5	GR6	GR7	GR8	GR9	GR10	LEA
\$2108	\$2293	\$2473	\$2656	\$2844	\$3024	\$3208	\$3389	\$3574	\$3758	\$3938	\$4113

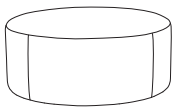

8342-NL 36" Round Ottoman / No Legs

COM Yardage: Total: 3.75 Yds. / Sides: 2.5 Yds. / Top: 1.25 Yds.

COM	GR1	GR2	GR3	GR4	GR5	GR6	GR7	GR8	GR9	GR10	LEA
\$2506	\$2688	\$2872	\$3057	\$3237	\$3421	\$3603	\$3787	\$3971	\$4152	\$4334	\$4508



8344-NL 42" Round Ottoman / No Legs

COM Yardage: Total: 4.25 Yds. / Sides: 2.75 Yds. / Top: 1.5 Yds.

COM	GR1	GR2	GR3	GR4	GR5	GR6	GR7	GR8	GR9	GR10	LEA
\$2718	\$2901	\$3085	\$3269	\$3451	\$3637	\$3818	\$3999	\$4183	\$4366	\$4550	\$4724

OPTIONS

Add upcharge to list price and code to model number

FR	CAL 133 (TB 133) Fire Retardant per yard	\$118	/yd.
MB	Moisture Barrier (1"-59"width)	\$164	ea.

2FO	Two Fabric Option	\$131	
-----	-------------------	-------	--

DIMENSIONS	27" Square	36" Square	42" Square
Overall Depth:	27"	36"	42"
Overall Width:	27"	36"	42"
Overall Height:	18"	18"	18"
Qty./Wt.:	1 ea./50 lbs.	1 ea./58 lbs.	1 ea./78 lbs.



27" SQUARE WITH CASTERS
AND FIXED TABLET ARMS



36" SQUARE OTTOMAN

MODEL / DESCRIPTION / LIST PRICING

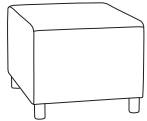

8346 27" Square Ottoman

COM Yardage: Total: 3 Yds. / Sides: 2 Yds. / Top: 1 Yds.

COM	GR1	GR2	GR3	GR4	GR5	GR6	GR7	GR8	GR9	GR10	LEA
\$1586	\$1782	\$1980	\$2173	\$2370	\$2568	\$2766	\$2961	\$3158	\$3353	\$3549	\$3738

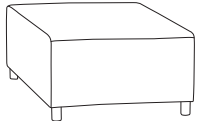

8348 36" Square Ottoman

COM Yardage: Total: 3.75 Yds. / Sides: 2.5 Yds. / Top: 1.25 Yds.

COM	GR1	GR2	GR3	GR4	GR5	GR6	GR7	GR8	GR9	GR10	LEA
\$2569	\$2780	\$2988	\$3196	\$3403	\$3612	\$3821	\$4027	\$4235	\$4442	\$4652	\$4852

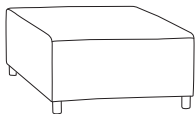

8350 42" Square Ottoman

COM Yardage: Total: 4.25 Yds. / Sides: 2.75 Yds. / Top: 1.5 Yds.

COM	GR1	GR2	GR3	GR4	GR5	GR6	GR7	GR8	GR9	GR10	LEA
\$3003	\$3212	\$3419	\$3626	\$3833	\$4043	\$4253	\$4459	\$4668	\$4876	\$5083	\$5282

OPTIONS

Add upcharge to list price and code to model number

FR	CAL 133 (TB 133) Fire Retardant per yard	\$118	/yd.
MB	Moisture Barrier (1"-59"width)	\$164	ea.
WOD	Solid Maple Wood Legs	\$32	ea.
PC	Polished Chrome Legs	\$34	ea.
CAS3	3" Locking Casters	\$34	ea.
2FO	Two Fabric Option	\$131	per unit

GD1	Ratchet Ganging Device for Soft Seating	\$112	per pair
GD2	Flat Ganging Device for Soft Seating	\$112	per pair
TABFB-(L)	Fixed Blade Tablet (outside or inside, specify (L/R), shape A, B or C)	\$593	ea. tablet
LAM5	Non-standard laminate (5 tablets or less)	\$554	ea. tablet
SST	Solid Surface Tablet Arm - add to tablet option	\$271	ea. tablet
SS5	Non-standard Solid Surface (5 tablets or less)	Call For Quote	

DIMENSIONS	Straight Benches
Overall Depth:	20"
Overall Width:	22, 44, 66"
Overall Height:	18"
Qty./Wt.:	1 ea./45/60/78 lbs.



THREE SEAT STRAIGHT BENCH

MODEL / DESCRIPTION / LIST PRICING

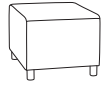

8352 Single Seat Straight Bench

COM Yardage: Total: 2.25 Yds. / Sides: 1.5 Yds. / Top: .75 Yds.

COM	GR1	GR2	GR3	GR4	GR5	GR6	GR7	GR8	GR9	GR10	LEA
\$1328	\$1444	\$1557	\$1686	\$1803	\$1933	\$2064	\$2194	\$2325	\$2457	\$2587	\$2774



8354 Two Seat Straight Bench

COM Yardage: Total: 3.25 Yds. / Sides: 1.75 Yds. / Top: 1.5 Yds.

COM	GR1	GR2	GR3	GR4	GR5	GR6	GR7	GR8	GR9	GR10	LEA
\$2468	\$2675	\$2884	\$3090	\$3298	\$3508	\$3715	\$3922	\$4130	\$4342	\$4548	\$4746



8356 Three Seat Straight Bench

COM Yardage: Total: 4.5 Yds. / Sides: 2.5 Yds. / Top: 2 Yds.

COM	GR1	GR2	GR3	GR4	GR5	GR6	GR7	GR8	GR9	GR10	LEA
\$2900	\$3109	\$3317	\$3526	\$3732	\$3940	\$4149	\$4358	\$4566	\$4771	\$4981	\$5181

OPTIONS

Add upcharge to list price and code to model number

FR	CAL 133 (TB 133) Fire Retardant per yard	\$118	/yd.	GD1	Ratchet Ganging Device for Soft Seating	\$112	per pair
MB	Moisture Barrier (1"-59"width)	\$164	ea.	GD2	Flat Ganging Device for Soft Seating	\$112	per pair
MB60	Moisture Barrier (60"and up)	\$262	ea.	TABFB- ()	Fixed Blade Tablet (outside or inside, specify (L/R), shape A, B or C)	\$593	ea. tablet
WOD	Solid Maple Wood Legs	\$32	ea.	LAM5	Non-standard laminate (5 tablets or less)	\$554	ea. tablet
PC	Polished Chrome Legs	\$34	ea.	SST	Solid Surface Tablet Arm - add to tablet option	\$271	ea. tablet
CAS3	3" Locking Casters - Black	\$34	ea.	SS5	Non-standard Solid Surface (5 tablets or less)	Call For Quote	
2FO	Two Fabric Option	\$131	per unit				

OPTIONS

- CODE: FR - CAL 133 (TB 133) Fire Retardant
- CODE: MB - Moisture Barrier (1"-59"width)
- CODE: LOW - Fully Upholstered Low Back - 27" OA Height
- CODE: WOD - Solid Maple Wood Legs with felt pads
- CODE: PC - Polished Chrome Legs
- CODE: CAS3 - 3" Locking Casters - Black
- CODE: 2FO - Two Fabric Option
- CODE: WAC - Wood Arm Caps
- CODE: PAC - Poly Arm Caps - Standard Black/Charcoal
- CODE: 3FO - Three Fabric Option
- CODE: GD1 - Ratchet Ganging Device for Soft Seating
- CODE: GD2 - Flat Ganging Device for Soft Seating

- CODE: GD3 - Flat Ganging Device for Café & Training Tables
- CODE: TAB-(_) - Non-Removable Swivel Tablet
(laminat shape A, B or C left or right arm)
- CODE: TABR1-(_) - Removable Swivel Tablet
(laminat shape A, B or C specify left or right arm)
- CODE: TABR2-(_) - Removable Swivel Tablet
(laminat shape A, B or C with opening for tablet on both arms)
- CODE: LAM5 - Non-standard laminate for 5 or less tablets
see options for upcharge
- CODE: SST - Solid Surface Tablet Arm - add to tablet option.
- CODE: SS5 - Non-standard Solid Surface top for 5 or less tablets
- CODE: CO - Clean Out (1"-59"width)
- CODE: CO1 - Clean Out (60"and up)

Note:

- Tablet orders of 5 or less - choice of 4 standard laminate colors:
Wilsonart Black 1595-60, Formica Brite White 459-58,
Wilsonart Montana Walnut 7110K-78 or
Nevamar Silver Alu Metalx MXT003.
- Tablet orders of 6 or more - any choice standard laminate colors.

Note: Factory installed power/data available, see accessories online under the 'Products' tab.



RAVEN LOUNGE



RAVEN TWO SEAT LOUNGE



LOW-BACK



3" LOCKING CASTERS

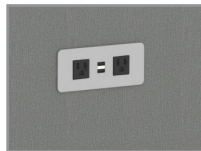

ELECTRICAL/DATA

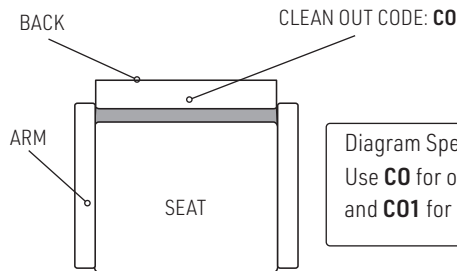

Diagram Specifies A Clean Out
Use **CO** for overall widths up to 50"
and **CO1** for overall widths over 50"

Note: Factory installed power/data available, see accessories online under the 'Products' tab.

TABLET SHAPES

Three Tablet Shapes::

Choose from the three shapes shown and specify; A, B or C and left or right (outside tablet) when ordering.
Example: TABF-(A) Left - this would be a fixed shape A tablet on the left side (when seated).

Laminate Top: Tops are 3/4"

- Tablet orders of 5 or less have 4 standard laminate colors:
- Wilsonart Black 1595-60
 - Formica Brite White 459-58
 - Wilsonart Montana Walnut 7110K-78
 - Nevamar Silver Alu Metalx MXT003
- Edge: 6F Multi-Ply

Solid Surface Top:

- Tablet orders of 5 or less have 4 standard Corian colors:
- Bone
 - Canyon
 - Glacier White
 - Silver Grey

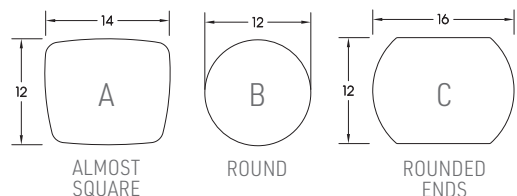

Note: Tablets can not be used with Arm Caps.

DIMENSIONS	Single Seat Lounge	Two Seat Lounge
Seat Depth:	20"	20"
Seat Height:	18"	18"
Arm Height:	25"	25"
Overall Depth:	27"	27"
Overall Width:	27"	49"
Overall Height:	33"	33"
Qty./Wt.:	1 ea./65 lbs.	1 ea./105 lbs.



RAVEN SINGLE LOUNGE WITH
OPTIONAL LOW BACK

MODEL / DESCRIPTION / LIST PRICING

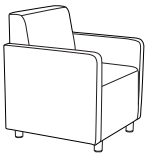

8403 Single Seat Lounge

COM Yardage: Total: 7 Yds. / Back: 2 Yds. / Seat: 2 Yds./ Arms(2) 3 Yds.

COM	GR1	GR2	GR3	GR4	GR5	GR6	GR7	GR8	GR9	GR10	LEA
\$2468	\$2730	\$2951	\$3228	\$3456	\$3698	\$3941	\$4183	\$4460	\$4738	\$5016	\$5526

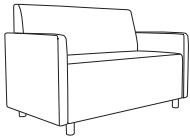

8401 Two Seat Lounge

COM Yardage: Total: 10 Yds. / Back: 4 Yds. / Seat: 3 Yds. / Arms(2) 3 Yds.

COM	GR1	GR2	GR3	GR4	GR5	GR6	GR7	GR8	GR9	GR10	LEA
\$3603	\$3952	\$4262	\$4612	\$4922	\$5234	\$5547	\$5858	\$6206	\$6553	\$6900	\$7410

Note: Clean out option is only available when units are facing the same direction.

OPTIONS

Add upcharge to list price and code to model number

FR	CAL 133 (TB 133) Fire Retardant per yard	\$118	/yd.	TAB-()	Swivel Tablet (specify A, B or C, left or right arm)	\$653	ea. tablet
MB	Moisture Barrier (1"-59"width)	\$164	ea.	TABR1-()	Removable Tablet (specify A, B or C, left or right arm)	\$756	ea. tablet
LOW	Fully Upholstered Low Back - 27" OA Height	\$124		TABR2-()	Removable Tablet (specify A, B or C both arm openings)	\$893	ea. tablet
WOD	Solid Maple Wood Legs	\$32	ea.	LAM5	Non-standard laminate (5 tablets or less)	\$554	ea. tablet
PC	Polished Chrome Legs	\$34	ea.	SST	Solid Surface Tablet Arm - add to tablet option	\$271	ea. tablet
PB	Laminate Plinth Base - Straight Unit	\$209		SS5	Non-standard Solid Surface (5 tablets or less)	Call For Quote	
CAS3	3" Locking Casters - Black	\$34	ea.	WAC	Wood Arm Cap	\$116	ea.
2FO	Two Fabric Option	\$131	per unit	PAC	Poly Arm Cap - Standard Black/Charcoal	\$89	ea.
3FO	Three Fabric Option	\$199	per unit	CO	Clean Out (1"-59"width)	\$327	
GD1	Ratchet Ganging Device for Soft Seating	\$112	per pair	CO1	Clean Out (60"and up)	\$503	
GD2	Flat Ganging Device for Soft Seating	\$112	per pair				

RAVEN JUNIOR COLLECTION

The Raven Junior Lounge Series offers great creativity and flexibility in children's seating. Designed for children's areas and any public spaces that require durable seating.



60° CURVE UNIT



RAVEN JUNIOR



RAVEN JUNIOR
MODULAR CONFIGURATION

ORDERING INFORMATION

- | | |
|----------------------------|-------------------------------|
| 1) Series Name | 5) Powder Coat Color for legs |
| 2) Model Number | 6) Optional Items |
| 3) Quantity | |
| 4) Fabric Grade and Number | |

STANDARD BASE FINISHES

4 Leg: Standard Powder Coat

OPTIONAL BASE FINISHES

4 Leg: Polished Chrome or Standard Wood Finish

GENERAL SPECIFICATIONS

Upholstery / Foam

Seat and back are covered in choice of fabric, vinyl, crypton, leather or COM. ERG uses only water based glues and adhesives in our upholstery process. All foam is fully bonded to frame. Seat cushions are 4" graded high resiliency (H.R.) block foam with back 3" (H.R.) foam, covered entirely with special bonded polyester fiber to protect final upholstery.

Frame Construction

Frame assembly is constructed of multi-ply hardwood, with tongue and groove construction. No sag-springs are installed in seat & back along with interlocking helicoil springs to prevent sagging and provide additional lower back and seat support.

Base Details

4 Leg: 2"RD X 3"H round tubular steel legs.

Metal legs - Poly Vinyl glides

Wood legs - with Felt pads

Casters: 3" Locking Casters

OPTIONS

- CODE: FR - CAL 133 (TB 133) Fire Retardant
- CODE: MB - Moisture Barrier (1"-59"width)
- CODE: WOD - Solid Maple Wood Legs
- CODE: PC - Polished Chrome Legs
- CODE: CAS3 - 3" Locking Casters - Black
- CODE: 2FO - Two Fabric Option
- CODE: GD1 - Ratchet Ganging Device for Soft Seating
- CODE: GD2 - Flat Ganging Device for Soft Seating



DIMENSIONS	Single Unit	Two Seat Unit	Two Seat Backless Unit	Square Ottoman	Round Ottomans
Seat Depth:	17.5"	17.5"	24"	-	-
Seat Height:	16"	16"	16"	-	-
Overall Depth:	24"	24"	24"	24"	18"
Overall Width:	18"	42"	42"	24"	18"
Overall Height:	27.5"	27.5"	16"	16"	16"
Qty./Wt.:	1 ea./35 lbs.	1 ea./60 lbs.	1 ea./55 lbs.	1 ea./40 lbs.	1 ea./26 lbs.



SINGLE UNIT

MODEL / DESCRIPTION / LIST PRICING



8400 Single Unit (4 Legs)

COM Yardage: Total: 3 Yds. / Back: 1.5 Yds. / Seat: 1.5 Yds.

COM	GR1	GR2	GR3	GR4	GR5	GR6	GR7	GR8	GR9	GR10	LEA
\$1432	\$1535	\$1594	\$1659	\$1726	\$1796	\$1868	\$1941	\$2017	\$2101	\$2185	\$2582



8402 Two Seat Unit (4 legs)

COM Yardage: Total: 4.5 Yds. / Back: 2.5 Yds. / Seat: 2 Yds.

COM	GR1	GR2	GR3	GR4	GR5	GR6	GR7	GR8	GR9	GR10	LEA
\$2283	\$2440	\$2538	\$2640	\$2745	\$2856	\$2969	\$3088	\$3213	\$3342	\$3474	\$4108



8404 Two Seat Backless Unit (4 legs)

COM Yardage: Total: 3.5 Yds. / Top: 1.5 Yds. / Sides: 2 Yds.

COM	GR1	GR2	GR3	GR4	GR5	GR6	GR7	GR8	GR9	GR10	LEA
\$1964	\$2091	\$2171	\$2248	\$2334	\$2423	\$2515	\$2610	\$2707	\$2812	\$2915	\$3425

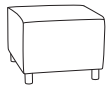

8406 24" Square Ottoman - 16" height (4 legs)

COM Yardage: Total: 2.75 Yds. / Top: .75 Yds. / Sides: 1.5 Yds.

COM	GR1	GR2	GR3	GR4	GR5	GR6	GR7	GR8	GR9	GR10	LEA
\$1305	\$1384	\$1436	\$1487	\$1540	\$1595	\$1658	\$1714	\$1779	\$1844	\$1910	\$2236

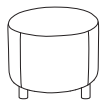

8341-S 18" Round Ottoman - 16" height (4 legs)

COM Yardage: Total: 2.75 Yds. / Sides: 2 Yds. / Top: .75 Yds.

COM	GR1	GR2	GR3	GR4	GR5	GR6	GR7	GR8	GR9	GR10	LEA
\$1325	\$1389	\$1441	\$1505	\$1569	\$1633	\$1712	\$1788	\$1865	\$1968	\$2070	\$2390

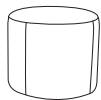

8341-NLS 18" Round Ottoman - 16" height / No Legs

COM Yardage: Total: 2.75 Yds. / Sides: 2 Yds. / Top: .75 Yds.

COM	GR1	GR2	GR3	GR4	GR5	GR6	GR7	GR8	GR9	GR10	LEA
\$1262	\$1327	\$1381	\$1445	\$1509	\$1574	\$1650	\$1727	\$1804	\$1907	\$2009	\$2330

OPTIONS

Add upcharge to list price and code to model number

FR	CAL 133 (TB 133) Fire Retardant per yard	\$118	/yd.
MB	Moisture Barrier (1"-59"width)	\$164	ea.
2FO	Two Fabric Option	\$131	per unit
GD1	Ratchet Ganging Device for Soft Seating	\$112	per pair

GD2	Flat Ganging Device for Soft Seating	\$112	per pair
PC	Polished Chrome Legs	\$34	ea.
CAS3	3" Locking Casters - Black	\$34	ea.
WOD	Solid Maple Wood Legs	\$32	ea.

DIMENSIONS	30° curve unit (inside / outside)	60° curve unit (inside / outside)	Backless 30° unit	Backless 60° unit
Seat Depth:	17.5"	17.5"	24"	24"
Seat Height:	16"	16"	16"	16"
Overall Depth:	26"	28"	26"	28"
Overall Width:	24.5"	47"	24.5"	47"
Overall Height:	27.5"	27.5"	16"	16"
Qty./Wt.:	1 ea./62 lbs.	1 ea./110 lbs.	1 ea./35 lbs.	1 ea./55 lbs.



60° CURVE UNIT



MODEL / DESCRIPTION / LIST PRICING



8408 30° inside curve unit (4 Legs)

COM Yardage: Total: 4 Yds. / Back: 2 Yds. / Seat: 2 Yds.

COM	GR1	GR2	GR3	GR4	GR5	GR6	GR7	GR8	GR9	GR10	LEA
\$1462	\$1551	\$1625	\$1689	\$1753	\$1817	\$1895	\$1972	\$2048	\$2153	\$2255	\$2574



8410 30° outside curve unit (4 Legs)

COM Yardage: Total: 4.5 Yds. / Back: 2 Yds. / Seat: 2.5 Yds.

COM	GR1	GR2	GR3	GR4	GR5	GR6	GR7	GR8	GR9	GR10	LEA
\$1607	\$1707	\$1788	\$1859	\$1929	\$2000	\$2085	\$2169	\$2255	\$2367	\$2480	\$2832

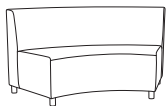

8412 60° inside curve unit (5 Legs)

COM Yardage: Total: 6.5 Yds. / Back: 4 Yds. / Seat: 2.5 Yds.

COM	GR1	GR2	GR3	GR4	GR5	GR6	GR7	GR8	GR9	GR10	LEA
\$2461	\$2635	\$2739	\$2848	\$2962	\$3081	\$3204	\$3335	\$3467	\$3603	\$3750	\$4433

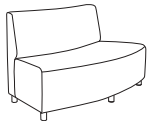

8414 60° outside curve unit (5 Legs)

COM Yardage: Total: 7 Yds. / Back: 3 Yds. / Seat: 4 Yds.

COM	GR1	GR2	GR3	GR4	GR5	GR6	GR7	GR8	GR9	GR10	LEA
\$2672	\$2845	\$2949	\$3059	\$3172	\$3291	\$3415	\$3544	\$3676	\$3814	\$3962	\$4643

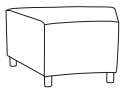

8416 Backless 30° unit (4 Legs)

COM Yardage: Total: 3 Yds. / Top: 1 Yds. / Sides: 2 Yds.

COM	GR1	GR2	GR3	GR4	GR5	GR6	GR7	GR8	GR9	GR10	LEA
\$1317	\$1409	\$1465	\$1524	\$1586	\$1649	\$1712	\$1781	\$1853	\$1928	\$2006	\$2368



8418 Backless 60° unit (5 Legs)

COM Yardage: Total: 4.75 Yds. / Top: 2 Yds. / Sides: 2.75 Yds.

COM	GR1	GR2	GR3	GR4	GR5	GR6	GR7	GR8	GR9	GR10	LEA
\$2073	\$2219	\$2310	\$2401	\$2496	\$2595	\$2700	\$2808	\$2919	\$3035	\$3155	\$3733

OPTIONS

Add upcharge to list price and code to model number

FR	CAL 133 (TB 133) Fire Retardant per yard	\$118	/yd.
MB	Moisture Barrier (1"-59"width)	\$164	ea.
2FO	Two Fabric Option	\$131	per unit
GD1	Ratchet Ganging Device for Soft Seating	\$112	per pair

GD2	Flat Ganging Device for Soft Seating	\$112	per pair
PC	Polished Chrome Legs	\$34	ea.
CAS3	3" Locking Casters - Black	\$34	ea.
WOD	Solid Maple Wood Legs	\$32	ea.