



**RAVEN TABLE OF CONTENTS**

Raven Specifications.....	2
Raven Banquette Options .....	3
Raven Banquette Pricing .....	4
Raven Banquette Privacy Panel Pricing .....	9
Raven Modular Options.....	10
Raven Modular Pricing.....	11
Raven Modular Privacy Panel Pricing.....	15
Raven Modular Backless Units .....	18
Raven Modular Individual Arms.....	20
Raven Modular Configurations .....	23
Raven Ottomans.....	25
Raven Benches .....	28
Raven Lounge Options.....	29
Raven Lounge Pricing .....	30
Raven Junior .....	31

**RAVEN**

The Raven collection offers an extensive variety of shapes and designs to fit a multitude of areas. The banquettes come in three different back heights, a choice of wood or metal legs or a plinth base, and a variety of privacy panels. The modular units offers straight or curved seating units, to create fun configurations, that have the flexibility to divide spaces in any open space. Raven also offers ottomans, lounge chairs and is complemented with Cabana tables to adapt to any design you dream up. Designed for higher education and any public space that requires long duration seating with comfort.



BANQUETTE



MODULAR



LOUNGE



OTTOMAN



CHILDREN'S

**ORDERING INFORMATION**

- |                 |                                  |
|-----------------|----------------------------------|
| 1) Series Name  | 4) Fabric Grade & Number         |
| 2) Model Number | 5) Panel Laminate/Edge Selection |
| 3) Quantity     | 6) Optional Items/Colors         |

SOFT SEATING	WEIGHT LIMIT
1 Seat	500 lbs.
2 Seat	1000 lbs.
3 Seat	1500 lbs.

**STANDARD BASE FINISHES**

**Metal Leg:** Standard Powder Coat

**OPTIONAL BASE FINISHES**

**Metal Leg:** Polished Chrome or Standard Wood Stain

**Wood Leg:** Standard Wood Stain



STANDARD BANQUETTE COMES WITH A FLUSH PLINTH BASE ON SIDES FOR GANGING, AND RECESSED FRONT.

**GENERAL SPECIFICATIONS**

**Upholstery / Foam**

Seat and back are covered in choice of fabric, vinyl, crypton, leather or COM. ERG uses only water based glues and adhesives in our upholstery process. All foam is fully bonded to frame. Seat cushions are 4" graded high resiliency (H.R.) block foam with back 3" (H.R.) foam, covered entirely with special bonded polyester fiber to protect final upholstery.

**Frame Construction**

Frame assembly is constructed of multi-ply hardwood, with tongue and groove construction. No sag-springs are installed in seat & back along with interlocking helicoil springs to prevent sagging and provide additional lower back and seat support.

**Base Details**

**Leg:** 2"RD X 3"H round tubular steel legs are standard.

**Metal legs** - Poly Vinyl glides

**Wood legs** - with Felt Pads

**Casters:** 3" Locking Casters

**Optional Plinth Base (Available only on Banquettes):** The optional base is available in a choice of laminate or unfinished so that you can add your own cover base or carpet (**clean out not available with plinth**)

**Anchoring**

Raven Banquettes are easy to anchor to the floor. Floor mount instructions can be provided by customer service. Hardware for anchoring bench to the floor is not included.

**Note for Edge of privacy panels:**

- Straight panels: available with 3MM PVC or laminate self edge. Select from any of our 3MM PVC edges in solid or wood tone, no custom colors available.
- Curved panels: will only be available with laminate self edge.
- Both straight and curved panels: when combining straight and curved, ONLY self edge is available.

*Raven Banquette  
Available in 3 heights  
27", 33" or 42"*

**OPTIONS**

- CODE: FR - CAL 133 (TB 133) Fire Retardant
- CODE: MB -Moisture Barrier (1"-59"width)
- CODE: MB60 -Moisture Barrier (60"and up)
- CODE: MBB -Moisture Barrier Back-to-Back (1"-59"width)
- CODE: MBB60 -Moisture Barrier Back-to-Back (60"and up)
- CODE: LOW - Fully Upholstered Low Back - 27" OA Height
- CODE: WOD - Solid Maple Wood Legs with felt pads
- CODE: PC - Polished Chrome Legs
- CODE: CAS2 - 2" Locking Casters - Black
- CODE: CAS3 - 3" Locking Casters - Black
- CODE: 2FO - Two Fabric Option
- CODE: GD1 - Ratchet Ganging Device for Soft Seating
- CODE: GD2 - Flat Ganging Device for Soft Seating
- CODE: GBP - Ganging Brackets For Plinth Base
- CODE: CO - Clean Out (1"-59"width)
- CODE: CO1 - Clean Out (60"and up)
- CODE: COB - Clean Out Back-to-Back (1"-59"width)
- CODE: CO1B - Clean Out Back-to-Back (60"and up)
- CODE: FMG - Floor Mount Glide
- CODE: PB - Plinth Base (1"-59"width)
- CODE: PB60 - Plinth Base (60"and up)
- CODE: PBB - Plinth Base Back-to-Back (1"-59"width)
- CODE: PBB60 - Plinth Base Back-to-Back (60"and up)
- CODE: UFB - Unfinished Plinth Base
- CODE: RB1 - Recessed Plinth Base (1 Side only)
- CODE: RB2 - Recessed Plinth Base (2 Sides)



POLISHED CHROME LEGS



WOOD LEGS



TWO FABRIC OPTION



CLEANOUT

**PLINTH OPTIONS**

The Optional Plinth comes..



FLOOR MOUNT GLIDE



OPTIONAL RECESSED PLINTH BASE  
AVAILABLE, ON ONE OR TWO SIDES.



OPTIONAL STANDARD GANGED PLINTH  
BASE, WITH 1/2" GAP BETWEEN BASES



LOW BACK  
27.5"



STANDARD BACK  
33"



HIGH BACK  
42"

Available on  
Banquette ONLY



HIGH BACK  
48"

Available on  
Banquette ONLY

**Note:** clean out options not available on plinth base units.

**Note:** Legs with Floor Mount Glide and standard capped legs cannot be mixed/ganged together.

DIMENSIONS	Straight Banquette
Seat Depth:	20"
Seat Height:	18"
Overall Depth:	27"
Overall Width:	48, 60, 72"
Overall Height:	33"
Qty./Wt.:	1 ea./150 lbs.



RAVEN BANQUETTE WITH OPTIONAL  
PLINTH BASE AND POWER/DATA  
UNIT

**MODEL / DESCRIPTION / LIST PRICING**

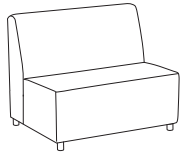

**8372** 48"W Straight Banquette (4 legs)

COM Yardage: Total: 7 Yds. / Back: 4 Yds. / Seat: 3 Yds.

COM	GR1	GR2	GR3	GR4	GR5	GR6	GR7	GR8	GR9	GR10	LEA
\$3060	\$3291	\$3519	\$3745	\$3977	\$4205	\$4435	\$4663	\$4893	\$5121	\$5351	\$5573

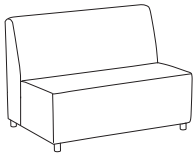

**8374** 60"W Straight Banquette (4 legs)

COM Yardage: Total: 9 Yds. / Back: 5 Yds. / Seat: 4 Yds.

COM	GR1	GR2	GR3	GR4	GR5	GR6	GR7	GR8	GR9	GR10	LEA
\$3823	\$4111	\$4396	\$4683	\$4967	\$5258	\$5542	\$5829	\$6116	\$6402	\$6689	\$6964

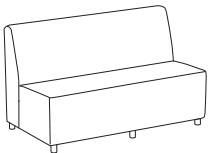

**8376** 72"W Straight Banquette (6 legs)

COM Yardage: Total: 11 Yds. / Back: 6 Yds. / Seat: 5 Yds.

COM	GR1	GR2	GR3	GR4	GR5	GR6	GR7	GR8	GR9	GR10	LEA
\$4809	\$5149	\$5494	\$5838	\$6182	\$6528	\$6870	\$7216	\$7557	\$7899	\$8245	\$8576

**Note:** Clean out option is only available when units are facing the same direction.

**Note:** clean out options not available on plinth base units.

**OPTIONS**

Add upcharge to list price and code to model number

FR	CAL 133 (TB 133) Fire Retardant per yard	\$123	/yd.
MB	Moisture Barrier (1"-59"width)	\$171	ea.
MB60	Moisture Barrier (60"and up)	\$272	ea.
LOW	Fully Upholstered Low Back - 27" OA Height	\$129	per unit
WOD	Solid Maple Wood Legs	\$33	ea.
PC	Polished Chrome Legs	\$35	ea.
CAS3	3" Locking Casters - Black	\$35	ea.
2FO	Two Fabric Option	\$136	per unit
GD1	Ratchet Ganging Device for Soft Seating	\$116	per pair
GD2	Flat Ganging Device for Soft Seating	\$116	per pair

GBP	Ganging Bracket for Plinth Base	\$297	per pair
CO	Clean Out (1"-59"width)	\$340	per unit
CO1	Clean Out (60"and up)	\$523	per unit
FMG	Floor Mount Glide	\$30	ea.
PB	Plinth Base (1"-59"width)	\$257	per unit
PB60	Plinth Base (60"and up)	\$435	per unit
UFB	Unfinished Plinth Base (deduct from plinth option)	Deduct \$80	
RB1	Recessed Base, 1 side	\$151	ea.
RB2	Recessed Base, 2 sides	\$298	ea.

DIMENSIONS	Corner Square Seat	Corner Curved Seat	Corner Curved Back Panel
Seat Depth:	21"	21"	21"
Seat Height:	18"	18"	18"
Overall Depth:	28"	28"	28"
Overall Width:	28"	28"	28"
Overall Height:	33"	33"	33"
Qty./Wt.:	1 ea./75 lbs.	1 ea./75 lbs.	1 ea./75 lbs.



CORNER UNIT - SQUARE SEAT



CORNER UNIT - CURVE SEAT



CORNER UNIT - CURVE BACK

**MODEL / DESCRIPTION / LIST PRICING**



**8386** Corner Unit - **Square Seat** (4 legs)

COM Yardage: Total: 6.5 Yds. / Back: 4.5 Yds. / Seat: 2 Yds.

COM	GR1	GR2	GR3	GR4	GR5	GR6	GR7	GR8	GR9	GR10	LEA
\$3254	\$3480	\$3619	\$3764	\$3914	\$4073	\$4233	\$4404	\$4581	\$4763	\$4954	\$5855



**8388** Corner Unit - **Curved Seat** (4 legs)

COM Yardage: Total: 6.5 Yds. / Back: 4.5 Yds. / Seat: 2 Yds.

COM	GR1	GR2	GR3	GR4	GR5	GR6	GR7	GR8	GR9	GR10	LEA
\$3538	\$3776	\$3920	\$4072	\$4227	\$4392	\$4560	\$4737	\$4922	\$5113	\$5312	\$6254



**8389** Corner Unit - **Curved Back** (4 legs)

COM Yardage: Total: 6.5 Yds. / Back: 4.5 Yds. / Seat: 2 Yds.

COM	GR1	GR2	GR3	GR4	GR5	GR6	GR7	GR8	GR9	GR10	LEA
\$3865	\$4123	\$4275	\$4441	\$4610	\$4784	\$4965	\$5159	\$5354	\$5560	\$5775	\$6783

**Note:** Clean out option is only available when units are facing the same direction.

**OPTIONS**

Add upcharge to list price and code to model number

FR	CAL 133 (TB 133) Fire Retardant per yard	\$123	/yd.
MB	Moisture Barrier (1"-59"width)	\$171	ea.
LOW	Fully Upholstered Low Back - 27" OA Height	\$129	
WOD	Solid Maple Wood Legs	\$33	ea.
PC	Polished Chrome Legs	\$35	ea.

CAS3	3" Locking Casters - Black	\$35	ea.
2FO	Two Fabric Option	\$136	
GD1	Ganging Device for Metal/Wood Legs	\$116	
GD2	Flat Ganging Device for Soft Seating	\$116	
CO	Clean Out (1"-59"width)	\$340	

DIMENSIONS	Back-to-Back Banquette
Seat Depth:	20"
Seat Height:	18"
Overall Depth:	51.5"
Overall Width:	48, 60, 72"
Overall Height:	33"
Qty./Wt.:	1 ea./280 lbs.



BACK-TO-BACK BANQUETTE WITH OPTIONAL CLEANOUT

**MODEL / DESCRIPTION / LIST PRICING**



**8380** 48"W Back-to-Back Banquette (6 legs)

COM Yardage: Total: 8 Yds. / Back: 3 Yds. / Seat: 5 Yds.

COM	GR1	GR2	GR3	GR4	GR5	GR6	GR7	GR8	GR9	GR10	LEA
\$5813	\$6248	\$6685	\$7117	\$7555	\$7988	\$8425	\$8860	\$9297	\$9730	\$10167	\$10587

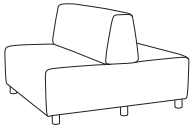

**8382** 60"W Back-to-Back Banquette (6 legs)

COM Yardage: Total: 11 Yds. / Back: 5 Yds. / Seat: 6 Yds.

COM	GR1	GR2	GR3	GR4	GR5	GR6	GR7	GR8	GR9	GR10	LEA
\$7268	\$7811	\$8352	\$8895	\$9444	\$9988	\$10533	\$11076	\$11619	\$12164	\$12707	\$13231

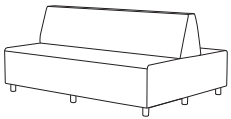

**8384** 72"W Back-to-Back Banquette (8 legs)

COM Yardage: Total: 13 Yds. / Back: 6 Yds. / Seat: 7 Yds.

COM	GR1	GR2	GR3	GR4	GR5	GR6	GR7	GR8	GR9	GR10	LEA
\$8940	\$9591	\$10246	\$10896	\$11548	\$12205	\$12859	\$13505	\$14162	\$14813	\$15470	\$16096

Note: To order Back to Back banquettes with privacy panel, the order will consist of two single straight units and privacy panel. The overall depth of these combined units with panel is 55". See page 8 for panel specs.

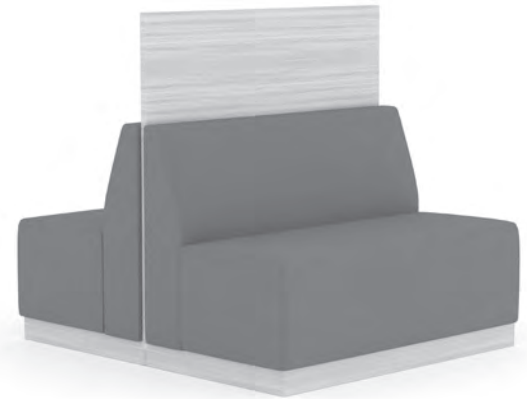

**Note:** Clean out option is only available when units are facing the same direction.

**Note:** clean out options not available on plinth base units.

**OPTIONS**

Add upcharge to list price and code to model number

FR	CAL 133 (TB 133) Fire Retardant per yard	\$123	/yd.
MBB	Moisture Barrier Back-to-Back (1"-59"width)	\$340	ea.
MBB60	Moisture Barrier Back-to-Back (60"and up)	\$543	ea.
WOD	Solid Maple Wood Legs	\$33	ea.
PC	Polished Chrome Legs	\$35	ea.
CAS3	3" Locking Casters - Black	\$35	ea.
2FO	Two Fabric Option	\$136	per unit
GD1	Ratchet Ganging Device for Soft Seating	\$116	per pair
GD2	Flat Ganging Device for Soft Seating	\$116	per pair

GBP	Ganging Bracket for Plinth Base	\$297	per pair
COB	Clean Out Back-to-Back (1"-59"width)	\$680	per unit
CO1B	Clean Out Back-to-Back (60"and up)	\$1,047	per unit
FMG	Floor Mount Glide	\$30	ea.
PBB	Plinth Base Back-To-Back (1"-59"width)	\$394	per unit
PBB60	Plinth Base Back-To-Back (60"and up)	\$598	per unit
UFB	Unfinished Plinth Base (deduct from plinth option)	Deduct \$80	
RB1	Recessed Base, 1 side	\$151	ea.
RB2	Recessed Base, 2 sides	\$298	ea.

DIMENSIONS	Straight Banquette
Seat Depth:	19.5"
Seat Height:	18"
Overall Depth:	27"
Overall Width:	48, 60, 72"
Overall Height:	42"
Qty./Wt.:	1 ea./150 lbs.



HIGH BACK BANQUETTE  
48"W X 42"H

**MODEL / DESCRIPTION / LIST PRICING**

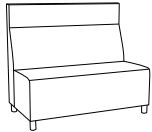

**8372HB** 48"W Straight High Back Banquette (4 legs)

COM Yardage: Total: 7.5 Yds. / Back: 4.5 Yds. / Seat: 3 Yds.

COM	GR1	GR2	GR3	GR4	GR5	GR6	GR7	GR8	GR9	GR10	LEA
\$4656	\$4982	\$5181	\$5388	\$5602	\$5828	\$6062	\$6304	\$6556	\$6819	\$7091	\$8382



**8374HB** 60"W Straight High Back Banquette (4 legs)

COM Yardage: Total: 9.5 Yds. / Back: 5.5 Yds. / Seat: 4 Yds.

COM	GR1	GR2	GR3	GR4	GR5	GR6	GR7	GR8	GR9	GR10	LEA
\$5728	\$6130	\$6374	\$6630	\$6895	\$7169	\$7458	\$7757	\$8065	\$8387	\$8722	\$10312

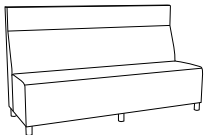

**8376HB** 72"W Straight High Back Banquette (6 legs)

COM Yardage: Total: 11.5 Yds. / Back: 6.5 Yds. / Seat: 5 Yds.

COM	GR1	GR2	GR3	GR4	GR5	GR6	GR7	GR8	GR9	GR10	LEA
\$7016	\$7495	\$7784	\$8087	\$8402	\$8730	\$9071	\$9423	\$9793	\$10174	\$10576	\$12457

**Note:** Clean out option is only available when units are facing the same direction.

**Note:** clean out options not available on plinth base units.

**OPTIONS**

Add upcharge to list price and code to model number

FR	CAL 133 (TB 133) Fire Retardant per yard	\$123	/yd.
MB	Moisture Barrier (1"-59"width)	\$171	ea.
MB60	Moisture Barrier (60"and up)	\$272	ea.
WOD	Solid Maple Wood Legs	\$33	ea.
PC	Polished Chrome Legs	\$35	ea.
CAS3	3" Locking Casters - Black	\$35	ea.
2FO	Two Fabric Option	\$136	per unit
GD1	Ratchet Ganging Device for Soft Seating	\$116	per pair
GD2	Flat Ganging Device for Soft Seating	\$116	per pair

GBP	Ganging Bracket for Plinth Base	\$297	per pair
CO	Clean Out (1"-59"width)	\$340	per unit
CO1	Clean Out (60"and up)	\$523	per unit
FMG	Floor Mount Glide	\$30	ea.
PB	Plinth Base (1"-59"width)	\$257	per unit
PB60	Plinth Base (60"and up)	\$435	per unit
UFB	Unfinished Plinth Base (deduct from plinth option)	Deduct \$80	
RB1	Recessed Base, 1 side	\$151	ea.
RB2	Recessed Base, 2 sides	\$298	ea.

DIMENSIONS	Back-to-Back Banquette
Seat Depth:	19.5"
Seat Height:	18"
Overall Depth:	51.5"
Overall Width:	48, 60, 72"
Overall Height:	42"
Qty./Wt.:	1 ea./290 lbs.



HIGH BACK BACK-TO-BACK BANQUETTE  
60"W X 42"H

**MODEL / DESCRIPTION / LIST PRICING**

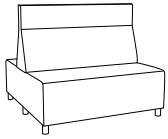

**8380HB** 48"W Back-to-Back High Back Banquette (6 legs)

COM Yardage: Total: 9 Yds. / Back: 4 Yds. / Seat: 5 Yds.

COM	GR1	GR2	GR3	GR4	GR5	GR6	GR7	GR8	GR9	GR10	LEA
\$8847	\$9466	\$9844	\$10240	\$10649	\$11075	\$11518	\$11978	\$12456	\$12955	\$13471	\$15927

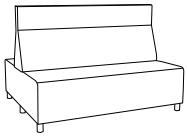

**8382HB** 60" W Back-to-Back High Back Banquette (6 legs)

COM Yardage: Total: 12 Yds. / Back: 6 Yds. / Seat: 6 Yds.

COM	GR1	GR2	GR3	GR4	GR5	GR6	GR7	GR8	GR9	GR10	LEA
\$10885	\$11646	\$12111	\$12599	\$13100	\$13625	\$14167	\$14737	\$15325	\$15935	\$16578	\$19592

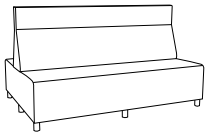

**8384HB** 72" W Back-to-Back High Back Banquette (8 legs)

COM Yardage: Total: 14 Yds. / Back: 7 Yds. / Seat: 7 Yds.

COM	GR1	GR2	GR3	GR4	GR5	GR6	GR7	GR8	GR9	GR10	LEA
\$13136	\$14040	\$14594	\$15170	\$15765	\$16389	\$17036	\$17708	\$18409	\$19134	\$19890	\$23470

**Note:** Clean out option is only available when units are facing the same direction.

**Note:** clean out options not available on plinth base units.

**OPTIONS**

Add upcharge to list price and code to model number

FR	CAL 133 (TB 133) Fire Retardant per yard	\$123	/yd.
MBB	Moisture Barrier Back-to-Back (1"-59"width)	\$340	ea.
MBB60	Moisture Barrier Back-to-Back (60"and up)	\$543	ea.
WOD	Solid Maple Wood Legs	\$33	ea.
PC	Polished Chrome Legs	\$35	ea.
CAS3	3" Locking Casters - Black	\$35	ea.
2FO	Two Fabric Option	\$136	per unit
GD1	Ratchet Ganging Device for Soft Seating	\$116	per pair
GD2	Flat Ganging Device for Soft Seating	\$116	per pair

GBP	Ganging Bracket for Plinth Base	\$297	per pair
COB	Clean Out Back-to-Back (1"-59"width)	\$680	per unit
C01B	Clean Out Back-to-Back (60"and up)	\$1,047	per unit
FMG	Floor Mount Glide	\$30	ea.
PBB	Plinth Base Back-To-Back (1"-59"width)	\$394	per unit
PBB60	Plinth Base Back-To-Back (60"and up)	\$598	per unit
UFB	Unfinished Plinth Base (deduct from plinth option)	Deduct \$80	
RB1	Recessed Base, 1 side	\$151	ea.
RB2	Recessed Base, 2 sides	\$298	ea.



DIMENSIONS	Straight Banquette
Seat Depth:	19.5"
Seat Height:	18"
Overall Depth:	27"
Overall Width:	48, 60, 72"
Overall Height:	48"
Qty./Wt.:	1 ea./155 lbs.



HIGH BACK BANQUETTE  
48"W X 48"H

**MODEL / DESCRIPTION / LIST PRICING**



**8371HB** 48"W Straight High Back Banquette (4 legs)

COM Yardage: Total: 8 Yds. / Back: 5 Yds. / Seat: 3 Yds.

COM	GR1	GR2	GR3	GR4	GR5	GR6	GR7	GR8	GR9	GR10	LEA
\$4862	\$5178	\$5370	\$5536	\$5769	\$5989	\$6277	\$6443	\$6634	\$6869	\$7116	\$8650

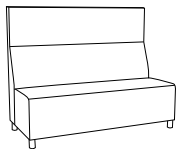

**8373HB** 60"W Straight High Back Banquette (4 legs)

COM Yardage: Total: 10 Yds. / Back: 6 Yds. / Seat: 4 Yds.

COM	GR1	GR2	GR3	GR4	GR5	GR6	GR7	GR8	GR9	GR10	LEA
\$5874	\$6190	\$6451	\$6713	\$6974	\$7234	\$7660	\$7825	\$8016	\$8389	\$8789	\$10597

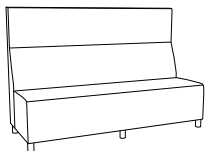

**8375HB** 72"W Straight High Back Banquette (6 legs)

COM Yardage: Total: 12.5 Yds. / Back: 7.5 Yds. / Seat: 5 Yds.

COM	GR1	GR2	GR3	GR4	GR5	GR6	GR7	GR8	GR9	GR10	LEA
\$7271	\$7641	\$7902	\$8239	\$8568	\$8830	\$9256	\$9557	\$9887	\$10259	\$10713	\$12930

**Note:** Clean out option is only available when units are facing the same direction.

**Note:** clean out options not available on plinth base units.

**OPTIONS**

Add upcharge to list price and code to model number

FR	CAL 133 (TB 133) Fire Retardant per yard	\$123	/yd.
MB	Moisture Barrier (1"-59"width)	\$171	ea.
MB60	Moisture Barrier (60"and up)	\$272	ea.
WOD	Solid Maple Wood Legs	\$33	ea.
PC	Polished Chrome Legs	\$35	ea.
CAS3	3" Locking Casters - Black	\$35	ea.
2FO	Two Fabric Option	\$136	per unit
GD1	Ratchet Ganging Device for Soft Seating	\$116	per pair
GD2	Flat Ganging Device for Soft Seating	\$116	per pair

GBP	Ganging Bracket for Plinth Base	\$297	per pair
CO	Clean Out (1"-59"width)	\$340	per unit
CO1	Clean Out (60"and up)	\$523	per unit
FMG	Floor Mount Glide	\$30	ea.
PB	Plinth Base (1"-59"width)	\$257	per unit
PB60	Plinth Base (60"and up)	\$435	per unit
UFB	Unfinished Plinth Base (deduct from plinth option)	Deduct \$80	
RB1	Recessed Base, 1 side	\$151	ea.
RB2	Recessed Base, 2 sides	\$298	ea.

DIMENSIONS	Back-to-Back Banquette
Seat Depth:	19.5"
Seat Height:	18"
Overall Depth:	51.5"
Overall Width:	48, 60, 72"
Overall Height:	48"
Qty./Wt.:	1 ea./295 lbs.



HIGH BACK BACK-TO-BACK BANQUETTE  
48"W X 48"H

**MODEL / DESCRIPTION / LIST PRICING**

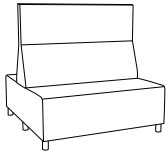

**8381HB** 48"W Back-to-Back High Back Banquette (6 legs)

COM Yardage: Total: 9.5 Yds. / Back: 4.5 Yds. / Seat: 5 Yds.

COM	GR1	GR2	GR3	GR4	GR5	GR6	GR7	GR8	GR9	GR10	LEA
\$9089	\$9543	\$10012	\$10313	\$10683	\$11083	\$11509	\$12086	\$12540	\$13186	\$13570	\$16478

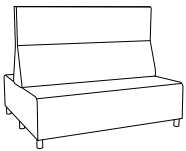

**8383HB** 60" W Back-to-Back High Back Banquette (6 legs)

COM Yardage: Total: 12.5 Yds. / Back: 6.5 Yds. / Seat: 6 Yds.

COM	GR1	GR2	GR3	GR4	GR5	GR6	GR7	GR8	GR9	GR10	LEA
\$11186	\$11777	\$12244	\$12684	\$13179	\$13713	\$14319	\$14895	\$15487	\$16134	\$16657	\$19836

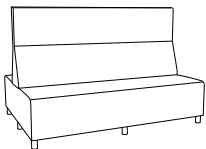

**8387HB** 72" W Back-to-Back High Back Banquette (8 legs)

COM Yardage: Total: 15 Yds. / Back: 8 Yds. / Seat: 7 Yds.

COM	GR1	GR2	GR3	GR4	GR5	GR6	GR7	GR8	GR9	GR10	LEA
\$13281	\$14146	\$14655	\$15232	\$15862	\$16537	\$17141	\$17858	\$18448	\$19231	\$20044	\$23638

**Note:** Clean out option is only available when units are facing the same direction.

**Note:** clean out options not available on plinth base units.

**OPTIONS**

Add upcharge to list price and code to model number

FR	CAL 133 (TB 133) Fire Retardant per yard	\$123	/yd.
MBB	Moisture Barrier Back-to-Back (1"-59"width)	\$340	ea.
MBB60	Moisture Barrier Back-to-Back (60"and up)	\$543	ea.
WOD	Solid Maple Wood Legs	\$33	ea.
PC	Polished Chrome Legs	\$35	ea.
CAS3	3" Locking Casters - Black	\$35	ea.
2FO	Two Fabric Option	\$136	per unit
GD1	Ratchet Ganging Device for Soft Seating	\$116	per pair
GD2	Flat Ganging Device for Soft Seating	\$116	per pair

GBP	Ganging Bracket for Plinth Base	\$297	per pair
COB	Clean Out Back-to-Back (1"-59"width)	\$680	per unit
C01B	Clean Out Back-to-Back (60"and up)	\$1,047	per unit
FMG	Floor Mount Glide	\$30	ea.
PBB	Plinth Base Back-To-Back (1"-59"width)	\$394	per unit
PBB60	Plinth Base Back-To-Back (60"and up)	\$598	per unit
UFB	Unfinished Plinth Base (deduct from plinth option)	Deduct \$80	
RB1	Recessed Base, 1 side	\$151	ea.
RB2	Recessed Base, 2 sides	\$298	ea.

**PRIVACY PANELS ONLY**

DIMENSIONS	48" Wide Privacy Panel	60" Wide Privacy Panel	72" Wide Privacy Panel
Panel Depth:	1"	1"	1"
Panel Width:	48"	60"	72"
Panel Height:	48"	48"	48"



RAVEN BACK TO BACK BANQUETTE WITH PRIVACY PANEL

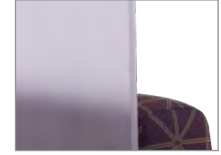

1/2" THICK ACRYLIC PRIVACY PANELS AVAILABLE

**MODEL / DESCRIPTION / LIST PRICING**

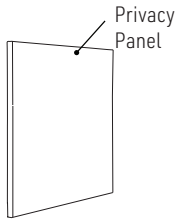

**8372P** 48" Wide Privacy Panel COM Yardage: Total: 3 Yds.

COM	GR1	GR2	GR3	GR4	GR5	GR6	GR7	GR8	GR9	GR10	LEA
\$1492	\$1597	\$1659	\$1727	\$1795	\$1868	\$1942	\$2019	\$2100	\$2184	\$2270	\$2683
LAMINATE			VENEER								
\$1461			\$2661								

**8374P** 60" Wide Privacy Panel COM Yardage: Total: 4 Yds.

COM	GR1	GR2	GR3	GR4	GR5	GR6	GR7	GR8	GR9	GR10	LEA
\$1968	\$2107	\$2188	\$2277	\$2368	\$2462	\$2557	\$2664	\$2770	\$2881	\$2996	\$3543
LAMINATE			VENEER								
\$1913			\$3423								

**8376P** 72" Wide Privacy Panel COM Yardage: Total: 5 Yds.

COM	GR1	GR2	GR3	GR4	GR5	GR6	GR7	GR8	GR9	GR10	LEA
\$2408	\$2577	\$2680	\$2789	\$2900	\$3015	\$3138	\$3262	\$3392	\$3527	\$3667	\$4337
LAMINATE			VENEER								
\$2322			\$4019								

**Note for Edge of privacy panels:**

- Straight panels: available with 3MM PVC or laminate self edge.  
Select from any of our 3MM PVC edges in solid or wood tone, no custom colors available.
- Curved panels: will only be available with laminate self edge.
- Both straight and curved panels: when combining straights and curved, ONLY self edge is available.

**Raven Modular Back Available in 2 heights 27" and 33"**

**OPTIONS**

- CODE: FR - CAL 133 (TB 133) Fire Retardant
- CODE: MB - Moisture Barrier (1"-59"width)
- CODE: MB60 - Moisture Barrier (60"and up)
- CODE: LOW - Fully Upholstered Low Back - 27" OA Height
- CODE: WOD - Solid Maple Wood Legs with felt pads
- CODE: WAC - Wood Arm Caps
- CODE: PAC - Poly Arm Caps - Standard Black/Charcoal
- CODE: PC - Polished Chrome Legs
- CODE: CAS3 - 3" Locking Casters - Black
- CODE: CO - Clean Out (1"-59"width)
- CODE: CO1 - Clean Out (60"and up)
- CODE: 2FO - Two Fabric Option
- CODE: GD1 - Ratchet Ganging Device for Soft Seating
- CODE: GD2 - Flat Ganging Device for Soft Seating
- CODE: GD3 - Flat Ganging Device for Café & Training Tables
- CODE: TABFB-( ) - Fixed Blade Tablet  
(outside or inside, specify (L/R), shape A, B or C)
- CODE: TABR1-( ) - Removable Swivel Tablet  
(laminated shape A, B or C specify left or right arm)
- CODE: TABR2-( ) - Removable Swivel Tablet  
(laminated shape A, B or C with opening for tablet on both arms)
- CODE: LAM5 - Non-standard laminate for 5 or less tablets  
see options for upcharge
- CODE: SST - Solid Surface Tablet
- CODE: SS5 - Non-standard Solid Surface top for 5 or less tablets



Note: Factory installed power/data available, see accessories online under the 'Products' tab.

Note: Legs with Floor Mount Glide and standard capped legs cannot be mixed/ganged together.

**TABLET SHAPES**

**Three Tablet Shapes::**

Choose from the three shapes shown and specify; A, B or C and left or right (outside tablet) when ordering.  
Example: TABFB- (A) Left - this would be a fixed shape A tablet on the left side (when seated).

**Laminated Top: Tops are 3/4"**

- Tablet orders of 5 or less have 4 standard laminate colors:
- Wilsonart Black 1595-60
  - Wilsonart Montana Walnut 7110K-78
  - Formica Brite White 459-58
  - Nevamar Silver Alu Metalx MXT003
- Edge: 6F Multi-Ply

**Solid Surface Top:**

- Tablet orders of 5 or less have 4 standard Corian colors:
- Bone
  - Canyon
  - Glacier White
  - Silver Grey

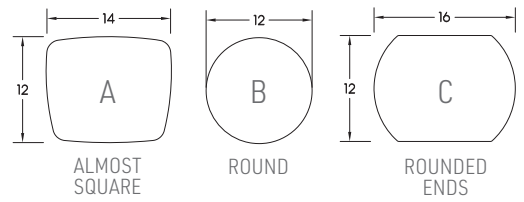

DIMENSIONS	22" Straight Unit	30" Straight Unit	44" Straight Unit
Seat Depth:	20"	20"	20"
Seat Height:	18"	18"	18"
Overall Depth:	27"	27"	27"
Overall Width:	22"	30"	44"
Overall Height:	33"	33"	33"
Qty./Wt.:	1 ea./44 lbs.	1 ea./44 lbs.	1 ea./44 lbs.



STRAIGHT UNITS - TABLET ARM AND ELECTRICAL OPTIONS

**MODEL / DESCRIPTION / LIST PRICING**



**8302** 22" W Straight Unit (4 legs)

COM Yardage: Total: 4 Yds. / Back: 2 Yds. / Seat: 2 Yds.

COM	GR1	GR2	GR3	GR4	GR5	GR6	GR7	GR8	GR9	GR10	LEA
\$1690	\$1814	\$1934	\$2076	\$2201	\$2337	\$2479	\$2619	\$2758	\$2900	\$3038	\$3242



**8304** 30" W Straight Unit (4 legs)

COM Yardage: Total: 5.25 Yds. / Back: 2.5 Yds. / Seat: 2.75 Yds.

COM	GR1	GR2	GR3	GR4	GR5	GR6	GR7	GR8	GR9	GR10	LEA
\$1824	\$1959	\$2101	\$2264	\$2410	\$2571	\$2733	\$2893	\$3054	\$3215	\$3410	\$3594

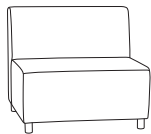

**8306** 44" W Straight Unit (4 legs)

COM Yardage: Total: 7 Yds. / Back: 4 Yds. / Seat: 3 Yds.

COM	GR1	GR2	GR3	GR4	GR5	GR6	GR7	GR8	GR9	GR10	LEA
\$2805	\$3015	\$3222	\$3432	\$3644	\$3854	\$4063	\$4274	\$4484	\$4691	\$4906	\$5106

**Note:** Clean out option is only available when units are facing the same direction.

**OPTIONS**

Add upcharge to list price and code to model number

FR	CAL 133 (TB 133) Fire Retardant per yard	\$123	/yd.
MB	Moisture Barrier (1"-59"width)	\$171	ea.
LOW	Fully Upholstered Low Back - 27" OA Height	\$129	
WOD	Solid Maple Wood Legs	\$33	ea.
PC	Polished Chrome Legs	\$35	ea.
CAS3	3" Locking Casters - Black	\$35	ea.
2FO	Two Fabric Option	\$136	per unit

GD1	Ratchet Ganging Device for Soft Seating	\$116	per pair
GD2	Flat Ganging Device for Soft Seating	\$116	per pair
TABFB-( )	Fixed Blade Tablet (outside or inside, specify (L/R), shape A, B or C)	\$617	ea. tablet
LAM5	Non-standard laminate (5 tablets or less)	\$576	ea. tablet
SST	Solid Surface Tablet Arm - add to tablet option	\$282	ea. tablet
SS5	Non-standard Solid Surface (5 tablets or less)	Call For Quote	
CO	Clean Out (1"-59"width)	\$340	

DIMENSIONS	30° Curve Inside	45° Curve Inside	60° Curve Inside
Seat Depth:	20"	20"	20"
Seat Height:	18"	18"	18"
Overall Depth:	29"	30.5"	32.5"
Overall Width:	35"	52"	67"
Overall Height:	33"	33"	33"
Qty./Wt.:	1 ea./64 lbs.	1 ea./84 lbs.	1 ea./115 lbs.



60° INSIDE CURVE WITH OPTIONAL POWER/  
DATA UNIT

**MODEL / DESCRIPTION / LIST PRICING**

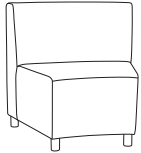

**8308** Inside 30° Curve Unit (4 legs)

COM Yardage: Total: 5.25 Yds. / Back: 2.75 Yds. / Seat: 2.5 Yds.

COM	GR1	GR2	GR3	GR4	GR5	GR6	GR7	GR8	GR9	GR10	LEA
\$1839	\$1961	\$2086	\$2225	\$2347	\$2484	\$2625	\$2763	\$2906	\$3045	\$3187	\$3390

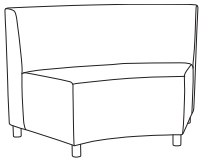

**8310** Inside 45° Curve Unit (4 legs)

COM Yardage: Total: 6 Yds. / Back: 3 Yds. / Seat: 3 Yds.

COM	GR1	GR2	GR3	GR4	GR5	GR6	GR7	GR8	GR9	GR10	LEA
\$2700	\$2875	\$3053	\$3246	\$3421	\$3612	\$3803	\$3998	\$4189	\$4383	\$4575	\$4776

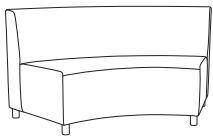

**8318** Inside 60° Curve Unit (5 legs)

COM Yardage: Total: 9 Yds. / Back: 5 Yds. / Seat: 4 Yds.

COM	GR1	GR2	GR3	GR4	GR5	GR6	GR7	GR8	GR9	GR10	LEA
\$3513	\$3687	\$3860	\$4056	\$4228	\$4423	\$4614	\$4807	\$4999	\$5192	\$5386	\$5588

**Note:** Clean out option is only available when units are facing the same direction.

**OPTIONS**

Add upcharge to list price and code to model number

FR	CAL 133 (TB 133) Fire Retardant per yard	\$123	/yd.
MB	Moisture Barrier (1"-59"width)	\$171	ea.
MB60	Moisture Barrier (60"and up)	\$272	ea.
LOW	Fully Upholstered Low Back - 27" OA Height	\$129	
WOD	Solid Maple Wood Legs	\$33	ea.
PC	Polished Chrome Legs	\$35	ea.
CAS3	3" Locking Casters - Black	\$35	ea.
2FO	Two Fabric Option	\$136	per unit

GD1	Ratchet Ganging Device for Soft Seating	\$116	per pair
GD2	Flat Ganging Device for Soft Seating	\$116	per pair
TABFB-( )	Fixed Blade Tablet (outside or inside, specify (L/R), shape A, B or C)	\$617	ea. tablet
LAM5	Non-standard laminate (5 tablets or less)	\$576	ea. tablet
SST	Solid Surface Tablet Arm - add to tablet option	\$282	ea. tablet
SS5	Non-standard Solid Surface (5 tablets or less)	Call For Quote	
CO	Clean Out (1"-59"width)	\$340	
CO1	Clean Out (60"and up)	\$523	

DIMENSIONS	20° Curve Outside	30° Curve Outside	45° Curve Outside	60° Curve Outside
Seat Depth:	20"	20"	20"	20"
Seat Height:	18"	18"	18"	18"
Overall Depth:	27"	29"	30.5"	32.5"
Overall Width:	23"	35"	52"	67"
Overall Height:	33"	33"	33"	33"
Qty./Wt.:	1 ea./44 lbs.	1 ea./64 lbs.	1 ea./85 lbs.	1 ea./110 lbs.



60 DEGREE OUTSIDE CURVE

**MODEL / DESCRIPTION / LIST PRICING**

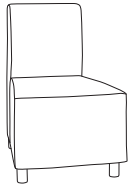

**8312** Outside 20° Curve Unit (4 legs)

COM Yardage: Total: 4.5 Yds. / Back: 2 Yds. / Seat: 2.5 Yds.

COM	GR1	GR2	GR3	GR4	GR5	GR6	GR7	GR8	GR9	GR10	LEA
\$1921	\$2060	\$2183	\$2322	\$2446	\$2588	\$2724	\$2867	\$3007	\$3146	\$3285	\$3487

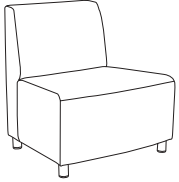

**8314** Outside 30° Curve Unit (4 legs)

COM Yardage: Total: 5 Yds. / Back: 2 Yds. / Seat: 3 Yds.

COM	GR1	GR2	GR3	GR4	GR5	GR6	GR7	GR8	GR9	GR10	LEA
\$2056	\$2193	\$2317	\$2456	\$2578	\$2720	\$2858	\$2999	\$3140	\$3278	\$3421	\$3618

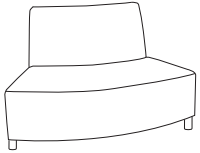

**8316** Outside 45° Curve Unit (4 legs)

COM Yardage: Total: 7 Yds. / Back: 3 Yds. / Seat: 4 Yds.

COM	GR1	GR2	GR3	GR4	GR5	GR6	GR7	GR8	GR9	GR10	LEA
\$3017	\$3192	\$3370	\$3561	\$3737	\$3928	\$4122	\$4314	\$4505	\$4700	\$4890	\$5091

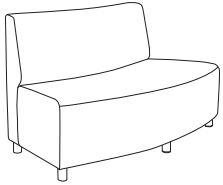

**8320** Outside 60° Curve Unit (5 legs)

COM Yardage: Total: 8 Yds. / Back: 3.5 Yds. / Seat: 4.5 Yds.

COM	GR1	GR2	GR3	GR4	GR5	GR6	GR7	GR8	GR9	GR10	LEA
\$3817	\$4009	\$4185	\$4378	\$4553	\$4743	\$4938	\$5129	\$5325	\$5515	\$5709	\$5910

**Note:** Clean out option is only available when units are facing the same direction.

**OPTIONS**

Add upcharge to list price and code to model number

FR	CAL 133 (TB 133) Fire Retardant per yard	\$123	/yd.
MB	Moisture Barrier (1"-59"width)	\$171	ea.
MB60	Moisture Barrier (60"and up)	\$272	ea.
LOW	Fully Upholstered Low Back - 27" OA Height	\$129	
WOD	Solid Maple Wood Legs	\$33	ea.
PC	Polished Chrome Legs	\$35	ea.
CAS3	3" Locking Casters - Black	\$35	ea.
2FO	Two Fabric Option	\$136	per unit

GD1	Ratchet Ganging Device for Soft Seating	\$116	per pair
GD2	Flat Ganging Device for Soft Seating	\$116	per pair
TABFB-( )	Fixed Blade Tablet (outside or inside, specify (L/R), shape A, B or C)	\$617	ea. tablet
LAM5	Non-standard laminate (5 tablets or less)	\$576	ea. tablet
SST	Solid Surface Tablet Arm - add to tablet option	\$282	ea. tablet
SS5	Non-standard Solid Surface (5 tablets or less)	Call For Quote	
CO	Clean Out (1"-59"width)	\$340	
CO1	Clean Out (60"and up)	\$523	

DIMENSIONS	Corner Square Seat	Corner Curved Seat	Corner Curved Back Panel
Seat Depth:	21"	21"	21"
Seat Height:	18"	18"	18"
Overall Depth:	28"	28"	28"
Overall Width:	28"	28"	28"
Overall Height:	33"	33"	33"
Qty./Wt.:	1 ea./75 lbs.	1 ea./75 lbs.	1 ea./75 lbs.



CORNER UNIT - SQUARE SEAT



CORNER UNIT - CURVE SEAT



CORNER UNIT - CURVE BACK

**MODEL / DESCRIPTION / LIST PRICING**



**8386** Corner Unit - **Square Seat** (4 legs)

COM Yardage: Total: 6.5 Yds. / Back: 4.5 Yds. / Seat: 2 Yds.

COM	GR1	GR2	GR3	GR4	GR5	GR6	GR7	GR8	GR9	GR10	LEA
\$3254	\$3480	\$3619	\$3764	\$3914	\$4073	\$4233	\$4404	\$4581	\$4763	\$4954	\$5855



**8388** Corner Unit - **Curved Seat** (4 legs)

COM Yardage: Total: 6.5 Yds. / Back: 4.5 Yds. / Seat: 2 Yds.

COM	GR1	GR2	GR3	GR4	GR5	GR6	GR7	GR8	GR9	GR10	LEA
\$3538	\$3776	\$3920	\$4072	\$4227	\$4392	\$4560	\$4737	\$4922	\$5113	\$5312	\$6254



**8389** Corner Unit - **Curved Back** (4 legs)

COM Yardage: Total: 6.5 Yds. / Back: 4.5 Yds. / Seat: 2 Yds.

COM	GR1	GR2	GR3	GR4	GR5	GR6	GR7	GR8	GR9	GR10	LEA
\$3865	\$4123	\$4275	\$4441	\$4610	\$4784	\$4965	\$5159	\$5354	\$5560	\$5775	\$6783

**Note:** Clean out option is only available when units are facing the same direction.

**OPTIONS**

Add upcharge to list price and code to model number

FR	CAL 133 (TB 133) Fire Retardant per yard	\$123	/yd.
MB	Moisture Barrier (1"-59"width)	\$171	ea.
MB60	Moisture Barrier (60"and up)	\$272	ea.
LOW	Fully Upholstered Low Back - 27" OA Height	\$129	
WOD	Solid Maple Wood Legs	\$33	ea.
PC	Polished Chrome Legs	\$35	ea.

CAS3	3" Locking Casters - Black	\$35	ea.
2FO	Two Fabric Option	\$136	
GD1	Ganging Device for Metal/Wood Legs	\$116	
GD2	Flat Ganging Device for Soft Seating	\$116	
CO	Clean Out (1"-59"width)	\$340	
CO1	Clean Out (60"and up)	\$523	



DIMENSIONS	Straight Unit	Straight Unit	Straight Unit
Panel Depth:	1"	1"	1"
Overall Width:	22"	30"	44"
Overall Height:	48"	48"	48"
Qty./Approx Wt.:	1 ea./100 lbs.	1 ea./110 lbs.	1 ea./120 lbs.



STRAIGHT UNIT

**MODEL / DESCRIPTION / LIST PRICING**

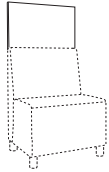

**8302P/U** 22"W Straight Unit COM Yardage: 1.5 Yds.

COM	GR1	GR2	GR3	GR4	GR5	GR6	GR7	GR8	GR9	GR10	LEA
\$1015	\$1089	\$1128	\$1175	\$1224	\$1271	\$1320	\$1374	\$1429	\$1487	\$1545	\$1827

**8302P/L** Laminate

Laminate
\$1245

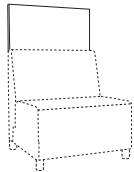

**8403P/U** 27"W Straight Unit COM Yardage: 1.5 Yds.

COM	GR1	GR2	GR3	GR4	GR5	GR6	GR7	GR8	GR9	GR10	LEA
\$1168	\$1252	\$1300	\$1352	\$1408	\$1459	\$1517	\$1581	\$1645	\$1710	\$1778	\$2101

**8403P/L** Laminate

Laminate
\$1431

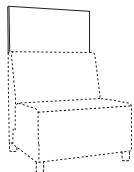

**8304P/U** 30"W Straight Unit COM Yardage: 2 Yds.

COM	GR1	GR2	GR3	GR4	GR5	GR6	GR7	GR8	GR9	GR10	LEA
\$1257	\$1348	\$1398	\$1454	\$1513	\$1576	\$1638	\$1702	\$1771	\$1845	\$1918	\$2265

**8304P/L** Laminate

Laminate
\$1510

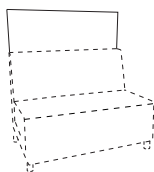

**8306P/U** 44"W Straight Unit COM Yardage: 3 Yds.

COM	GR1	GR2	GR3	GR4	GR5	GR6	GR7	GR8	GR9	GR10	LEA
\$1447	\$1546	\$1604	\$1674	\$1738	\$1809	\$1880	\$1957	\$2037	\$2116	\$2203	\$2603

**8306P/L** Laminate

Laminate
\$1739

**Note for Edge of privacy panels:**

- Straight panels: available with 3MM PVC or laminate self edge.  
Select from any of our 3MM PVC edges in solid or wood tone, no custom colors available.
- Curved panels: will only be available with laminate self edge.
- Both straight and curved panels: when combining straights and curved, ONLY self edge is available.

**OPTIONS**

Add upcharge to list price and code to model number

FR	CAL 133 (TB 133) Fire Retardant per yard	\$123	/yd.
----	--	-------	------

2FO	Two Fabric Option	\$136	
-----	-------------------	-------	--

DIMENSIONS	30° Curve Inside	45° Curve Inside	60° Curve Inside
Panel Depth:	1"	1"	1"
Overall Width:	35"	52"	67"
Overall Height:	48"	48"	48"
Qty./Approx Wt.:	1 ea./135 lbs.	1 ea./145 lbs.	1 ea./160 lbs.



INSIDE CURVE UNIT

**MODEL / DESCRIPTION / LIST PRICING**

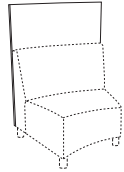

**8308P/U** Inside 30° Curve Unit COM Yardage: 2 Yds.

COM	GR1	GR2	GR3	GR4	GR5	GR6	GR7	GR8	GR9	GR10	LEA
\$1884	\$2017	\$2099	\$2181	\$2267	\$2357	\$2454	\$2551	\$2653	\$2760	\$2870	\$3392

**8308P/L** Laminate

Laminate
\$2470

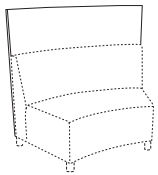

**8310P/U** Inside 45° Curve Unit COM Yardage: 3 Yds.

COM	GR1	GR2	GR3	GR4	GR5	GR6	GR7	GR8	GR9	GR10	LEA
\$2168	\$2319	\$2414	\$2511	\$2607	\$2713	\$2824	\$2936	\$3050	\$3174	\$3300	\$3901

**8310P/L** Laminate

Laminate
\$2840

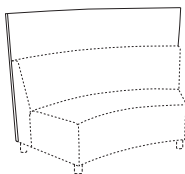

**8318P/U** Inside 60° Curve Unit COM Yardage: 4 Yds.

COM	GR1	GR2	GR3	GR4	GR5	GR6	GR7	GR8	GR9	GR10	LEA
\$3384	\$3621	\$3767	\$3918	\$4072	\$4238	\$4404	\$4580	\$4763	\$4956	\$5151	\$6092

**8318P/L** Laminate

Laminate
\$4427

**Note for Edge of privacy panels:**

- Straight panels: available with 3MM PVC or laminate self edge.  
Select from any of our 3MM PVC edges in solid or wood tone, no custom colors available.
- Curved panels: will only be available with laminate self edge.
- Both straight and curved panels: when combining straights and curved, ONLY self edge is available.

**OPTIONS**

Add upcharge to list price and code to model number

FR	CAL 133 (TB 133) Fire Retardant per yard	\$123	/yd.
----	--	-------	------

2FO	Two Fabric Option	\$136	
-----	-------------------	-------	--

DIMENSIONS	20° Curve Outside	30° Curve Outside	45° Curve Outside	60° Curve Outside
Panel Depth:	1"	1"	1"	1"
Overall Width:	22"	35"	52"	67"
Overall Height:	48"	48"	48"	48"
Qty./Approx Wt.:	1 ea./120 lbs.	1 ea./135 lbs.	1 ea./145 lbs.	1 ea./160 lbs.



OUTSIDE CURVE UNIT

**MODEL / DESCRIPTION / LIST PRICING**

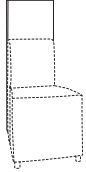

**8312P/U** Outside 20° Curve Unit COM Yardage: 1.5 Yds.

COM	GR1	GR2	GR3	GR4	GR5	GR6	GR7	GR8	GR9	GR10	LEA
\$1319	\$1412	\$1467	\$1526	\$1584	\$1652	\$1716	\$1786	\$1853	\$1929	\$2008	\$2373

**8312P/L** Laminate

Laminate
\$1878

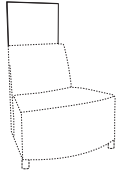

**8314P/U** Outside 30° Curve Unit COM Yardage: 2 Yds.

COM	GR1	GR2	GR3	GR4	GR5	GR6	GR7	GR8	GR9	GR10	LEA
\$1884	\$2017	\$2099	\$2181	\$2267	\$2357	\$2454	\$2551	\$2653	\$2760	\$2870	\$3392

**8314P/L** Laminate

Laminate
\$2622

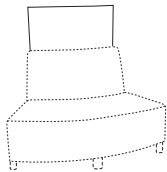

**8316P/U** Outside 45° Curve Unit COM Yardage: 2 Yds.

COM	GR1	GR2	GR3	GR4	GR5	GR6	GR7	GR8	GR9	GR10	LEA
\$2168	\$2319	\$2414	\$2511	\$2607	\$2713	\$2824	\$2936	\$3050	\$3174	\$3300	\$3901

**8316P/L** Laminate

Laminate
\$2991

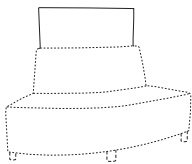

**8320P/U** Outside 60° Curve Unit COM Yardage: 3 Yds.

COM	GR1	GR2	GR3	GR4	GR5	GR6	GR7	GR8	GR9	GR10	LEA
\$3384	\$3621	\$3767	\$3918	\$4072	\$4238	\$4404	\$4580	\$4763	\$4956	\$5151	\$6092

**8320P/L** Laminate

Laminate
\$4577

**Note for Edge of privacy panels:**

- Straight panels: available with 3MM PVC or laminate self edge. Select from any of our 3MM PVC edges in solid or wood tone, no custom colors available.
- Curved panels: will only be available with laminate self edge.
- Both straight and curved panels: when combining straights and curved, ONLY self edge is available.

**OPTIONS**

Add upcharge to list price and code to model number

FR	CAL 133 (TB 133) Fire Retardant per yard	\$123	/yd.
----	--	-------	------

2FO	Two Fabric Option	\$133	
-----	-------------------	-------	--

DIMENSIONS	Straight Backless	Bariatric Backless
Seat Depth:	27"	27"
Seat Height:	18"	18"
Overall Depth:	27"	27"
Overall Width:	22", 44"	30"
Overall Height:	18"	18"
Qty./Wt.:	1 ea./40/60 lbs.	1 ea./80 lbs.



SINGLE SEAT BACKLESS WITH OPTIONAL TWO FABRIC

**MODEL / DESCRIPTION / LIST PRICING**

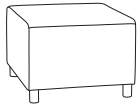

**8326** Single Seat Backless Unit 22"

COM Yardage: Total: 2.5 Yds. / Sides: 1.5 Yds. / Top: 1 Yds.

COM	GR1	GR2	GR3	GR4	GR5	GR6	GR7	GR8	GR9	GR10	LEA
\$1478	\$1606	\$1731	\$1875	\$2000	\$2146	\$2291	\$2433	\$2578	\$2722	\$2868	\$3075

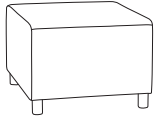

**8328** Bariatric Backless Unit 30"

COM Yardage: Total: 3 Yds. / Sides: 2 Yds. / Top: 1 Yds.

COM	GR1	GR2	GR3	GR4	GR5	GR6	GR7	GR8	GR9	GR10	LEA
\$1699	\$1896	\$2098	\$2297	\$2496	\$2695	\$2893	\$3090	\$3292	\$3489	\$3688	\$3881



**8330** Two Seat Backless Unit 44"

COM Yardage: Total: 4 Yds. / Sides: 2.5 Yds. / Top: 1.5 Yds.

COM	GR1	GR2	GR3	GR4	GR5	GR6	GR7	GR8	GR9	GR10	LEA
\$2670	\$2885	\$3103	\$3320	\$3536	\$3754	\$3968	\$4185	\$4401	\$4618	\$4835	\$5042

**OPTIONS**

Add upcharge to list price and code to model number

FR	CAL 133 (TB 133) Fire Retardant per yard	\$123	/yd.	GD1	Ratchet Ganging Device for Soft Seating	\$116	per pair
MB	Moisture Barrier (1"-59"width)	\$171	ea.	GD2	Flat Ganging Device for Soft Seating	\$116	per pair
WOD	Solid Maple Wood Legs	\$33	ea.	TABFB-( )	Fixed Blade Tablet (outside or inside, specify (L/R), shape A, B or C)	\$617	ea. tablet
PC	Polished Chrome Legs	\$35	ea.	LAM5	Non-standard laminate (5 tablets or less)	\$576	ea. tablet
CAS3	3" Locking Casters - Black	\$35	ea.	SST	Solid Surface Tablet Arm - add to tablet option	\$282	ea. tablet
2FO	Two Fabric Option	\$136	per unit	SS5	Non-standard Solid Surface (5 tablets or less)	Call For Quote	

DIMENSIONS	20° Curve Backless	30° Curve Backless	45° Curve Backless	60° Curve Backless
Seat Depth:	27"	27"	27"	27"
Seat Height:	18"	18"	18"	18"
Overall Depth:	28"	29"	30.5"	32.5"
Overall Width:	32"	35"	52"	67"
Overall Height:	18"	18"	18"	18"
Qty./Wt.:	1 ea./42 lbs.	1 ea./62 lbs.	1 ea./82 lbs.	1 ea./102 lbs.



60° CURVE BACKLESS UNIT

**MODEL / DESCRIPTION / LIST PRICING**

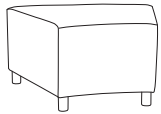

**8332** 20° Curve Unit (4 legs)

COM Yardage: Total: 2.75 Yds. / Sides: 1.75 Yds. / Top: 1 Yds.

COM	GR1	GR2	GR3	GR4	GR5	GR6	GR7	GR8	GR9	GR10	LEA
\$1656	\$1783	\$1909	\$2056	\$2182	\$2325	\$2469	\$2612	\$2757	\$2903	\$3045	\$3252

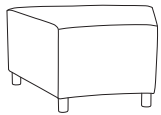

**8334** 30° Curve Unit (4 legs)

COM Yardage: Total: 3.5 Yds. / Sides: 2 Yds. / Top: 1.5 Yds.

COM	GR1	GR2	GR3	GR4	GR5	GR6	GR7	GR8	GR9	GR10	LEA
\$1779	\$1906	\$2032	\$2175	\$2302	\$2447	\$2593	\$2737	\$2879	\$3025	\$3170	\$3376

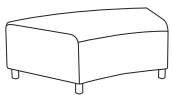

**8336** 45° Curve Unit (4 legs)

COM Yardage: Total: 5 Yds. / Sides: 3.25 Yds. / Top: 1.75 Yds.

COM	GR1	GR2	GR3	GR4	GR5	GR6	GR7	GR8	GR9	GR10	LEA
\$2475	\$2599	\$2724	\$2871	\$2996	\$3142	\$3284	\$3429	\$3576	\$3718	\$3863	\$4072

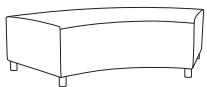

**8338** 60° Curve Unit (5 legs)

COM Yardage: Total: 5.5 Yds. / Sides: 3 Yds. / Top: 2.5 Yds.

COM	GR1	GR2	GR3	GR4	GR5	GR6	GR7	GR8	GR9	GR10	LEA
\$3025	\$3149	\$3276	\$3422	\$3545	\$3691	\$3834	\$3980	\$4124	\$4267	\$4411	\$4619

**OPTIONS**

Add upcharge to list price and code to model number

FR	CAL 133 (TB 133) Fire Retardant per yard	\$123	/yd.
MB	Moisture Barrier (1"-59"width)	\$171	ea.
MB60	Moisture Barrier (60"and up)	\$272	ea.
WOD	Solid Maple Wood Legs	\$33	ea.
PC	Polished Chrome Legs	\$35	ea.
CAS3	3" Locking Casters - Black	\$35	ea.
2FO	Two Fabric Option	\$136	per unit

GD1	Ratchet Ganging Device for Soft Seating	\$116	per pair
GD2	Flat Ganging Device for Soft Seating	\$116	per pair
TABFB-( )	Fixed Blade Tablet (outside or inside, specify (L/R), shape A, B or C)	\$617	ea. tablet
LAM5	Non-standard laminate (5 tablets or less)	\$576	ea. tablet
SST	Solid Surface Tablet Arm - add to tablet option	\$282	ea. tablet
SS5	Non-standard Solid Surface (5 tablets or less)	Call For Quote	



SINGLE SEAT WITH ARMS

DIMENSIONS	R-L Arm	Center Arm
Overall Depth:	27"	19"
Overall Width:	3"	2"
Overall Height:	25"	21"
Qty./Wt.:	1 ea./25 lbs.	1 ea./10 lbs.

**MODEL / DESCRIPTION / LIST PRICING**

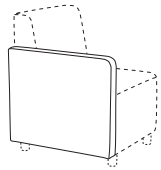

**8358L/R** Left or Right Arm

COM Yardage: 1.5 Yds..

COM	GR1	GR2	GR3	GR4	GR5	GR6	GR7	GR8	GR9	GR10	LEA
\$427	\$511	\$574	\$658	\$718	\$778	\$840	\$904	\$987	\$1066	\$1149	\$1336

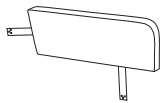

**8358C** Center Arm (ARM CAP NOT AVAILABLE)

COM Yardage: .75 Yds..

COM	GR1	GR2	GR3	GR4	GR5	GR6	GR7	GR8	GR9	GR10	LEA
\$416	\$500	\$558	\$641	\$702	\$768	\$830	\$889	\$973	\$1055	\$1139	\$1322

**Note:** Tablet options available on full left or right arm only and cannot be used with arm caps.

**OPTIONS**

Add upcharge to list price and code to model number

FR	CAL 133 (TB 133) Fire Retardant per yard	\$123	/yd.	SST	Solid Surface Tablet Arm - add to tablet option	\$282	ea. tablet
TAB-( )	Swivel Tablet (specify A, B or C, left or right arm)	\$679	ea. tablet	SS5	Non-standard Solid Surface (5 tablets or less)	Call For Quote	
TABR1-( )	Removable Tablet (specify A, B or C, left or right arm)	\$786	ea. tablet	WAC	Single Wood Arm Cap	\$121	
TABR2-( )	Removable Tablet (specify A, B or C both arm openings)	\$929	ea. tablet	PAC	Poly Arm Cap - Standard Black/Charcoal	\$93	ea.
LAM5	Non-standard laminate (5 tablets or less)	\$576	ea. tablet				



"S" CONFIGURATION: SIX 60° CURVE UNITS, TWO 60° BACKLESS CURVE UNITS WITH CABANA OCCASIONAL TABLES

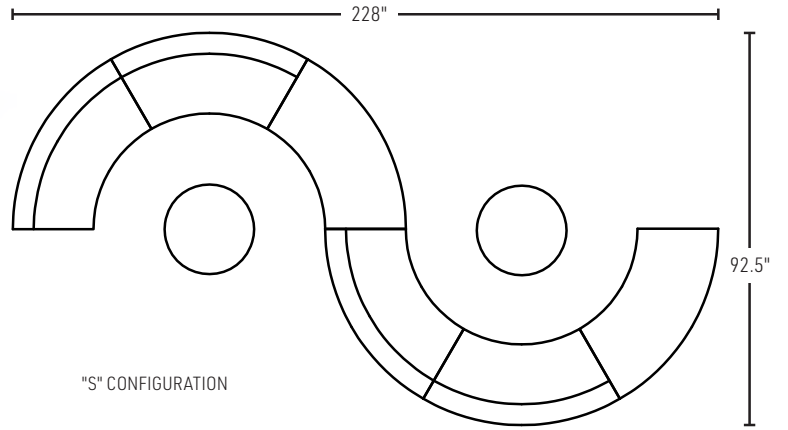

THREE 60° CURVE UNITS, TWO OUTSIDE ARMS, TWO LOUNGE UNITS AND 36" ROUND CABANA TABLE WITH COVE POWER OPTION

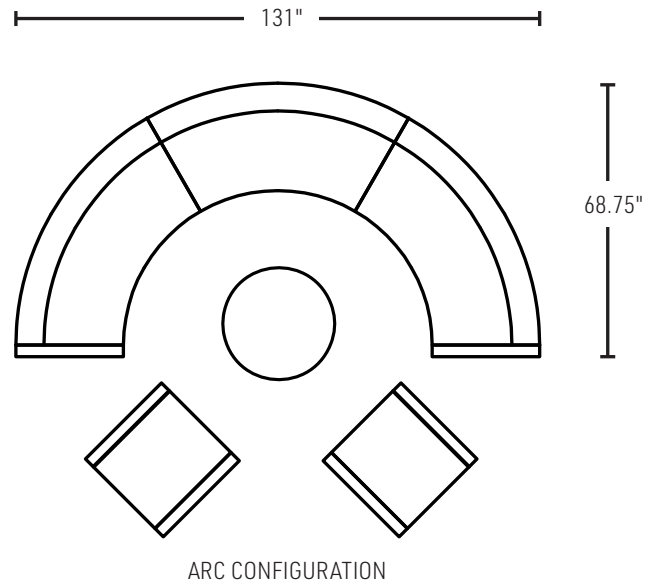



SERPENTINE CONFIGURATION

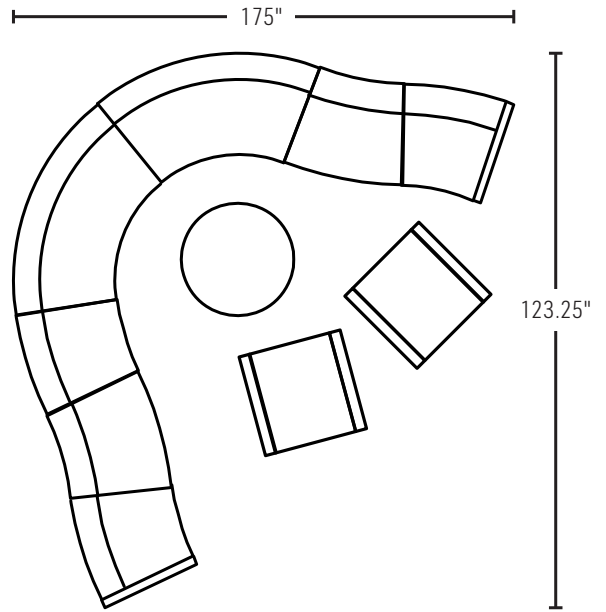

"L" SHAPE CONFIGURATION

ONE CORNER UNIT, SIX STRAIGHT UNITS,, TWO OUTSIDE ARMS, TWO LOUNGE UNITS AND TWO CABANA OCCASIONAL TABLES FEATURING COVE POWER OPTION

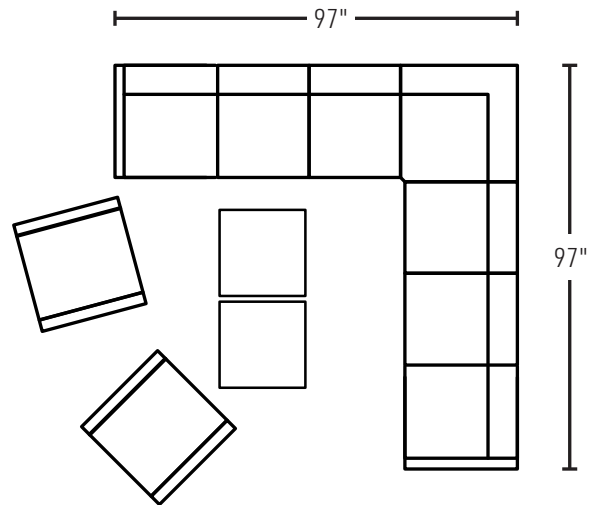



DIMENSIONS	18" Round	24" Round	30" Round	36" Round	42" Round
Overall Depth:	18"	24"	30"	36"	42"
Overall Width:	18"	24"	30"	36"	42"
Overall Height:	16" or 18"	18"	18"	18"	18"
Qty./Wt.:	1 ea./26 lbs.	1 ea./37 lbs.	1 ea./48 lbs.	1 ea./68 lbs.	1 ea./84 lbs.



36" ROUND OTTOMAN

**MODEL / DESCRIPTION / LIST PRICING**

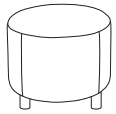

**8341-S** 18" Round Ottoman - **16" height** (4 legs) (4 - 2" Casters Needed) COM Yardage: Total: 2.75 Yds. / Sides: 2 Yds. / Top: .75 Yds.

COM	GR1	GR2	GR3	GR4	GR5	GR6	GR7	GR8	GR9	GR10	LEA
\$1378	\$1445	\$1499	\$1565	\$1632	\$1698	\$1780	\$1860	\$1940	\$2047	\$2153	\$2486

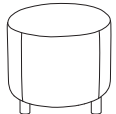

**8341** 18" Round Ottoman (4 legs) (4 - 2" Casters Needed) COM Yardage: Total: 2.75 Yds. / Sides: 2 Yds. / Top: .75 Yds.

COM	GR1	GR2	GR3	GR4	GR5	GR6	GR7	GR8	GR9	GR10	LEA
\$1411	\$1478	\$1535	\$1601	\$1668	\$1734	\$1814	\$1894	\$1976	\$2081	\$2188	\$2521

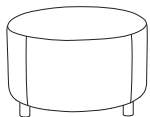

**8339** 24" Round Ottoman (4 legs) (4 Casters Needed) COM Yardage: Total: 2.75 Yds. / Sides: 2 Yds. / Top: .75 Yds.

COM	GR1	GR2	GR3	GR4	GR5	GR6	GR7	GR8	GR9	GR10	LEA
\$1745	\$1962	\$2179	\$2394	\$2610	\$2827	\$3044	\$3259	\$3477	\$3692	\$3909	\$4117

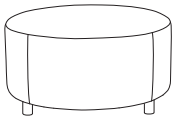

**8340** 30" Round Ottoman (4 legs) (4 Casters Needed) COM Yardage: Total: 3.5 Yds. / Sides: 2.5 Yds. / Top: 1 Yds.

COM	GR1	GR2	GR3	GR4	GR5	GR6	GR7	GR8	GR9	GR10	LEA
\$2399	\$2616	\$2833	\$3052	\$3267	\$3480	\$3697	\$3914	\$4131	\$4347	\$4561	\$4773

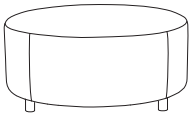

**8342** 36" Round Ottoman (4 legs) (4 Casters Needed) COM Yardage: Total: 4.25 Yds. / Sides: 2.75 Yds. / Top: 1.25 Yds.

COM	GR1	GR2	GR3	GR4	GR5	GR6	GR7	GR8	GR9	GR10	LEA
\$2885	\$3103	\$3320	\$3536	\$3754	\$3968	\$4185	\$4401	\$4618	\$4835	\$5050	\$5259

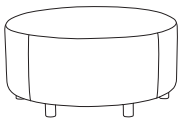

**8344** 42" Round Ottoman (6 legs) (6 Casters Needed) COM Yardage: Total: 4.5 Yds. / Sides: 2.75 Yds. / Top: 1.25 Yds.

COM	GR1	GR2	GR3	GR4	GR5	GR6	GR7	GR8	GR9	GR10	LEA
\$3118	\$3336	\$3553	\$3766	\$3984	\$4202	\$4417	\$4631	\$4851	\$5069	\$5283	\$5489

**OPTIONS**

Add upcharge to list price and code to model number

FR	CAL 133 (TB 133) Fire Retardant per yard	\$123	/yd.
MB	Moisture Barrier (1"-59"width)	\$171	ea.
WOD	Solid Maple Wood Legs	\$33	ea.
PC	Polished Chrome Legs	\$35	ea.

CAS2	2" Locking Casters - Black (18" size Only)	\$29	ea.
CAS3	3" Locking Casters - Black (not available on 18" size)	\$35	ea.
2FO	Two Fabric Option	\$136	

DIMENSIONS	18" Round	24" Round	30" Round	36" Round	42" Round
Overall Depth:	18"	24"	30"	36"	42"
Overall Width:	18"	24"	30"	36"	42"
Overall Height:	16" or 18"	18"	18"	18"	18"
Qty./Wt.:	1 ea./26 lbs.	1 ea./37 lbs.	1 ea./48 lbs.	1 ea./68 lbs.	1 ea./84 lbs.



ROUND OTTOMAN / NO LEGS  
W/ PLASTIC GLIDES

**MODEL / DESCRIPTION / LIST PRICING**

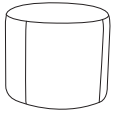

**8341-NLS 18" Round Ottoman - 16" height / No Legs**

COM Yardage: Total: 2.75 Yds. / Sides: 2 Yds. / Top: .75 Yds.

COM	GR1	GR2	GR3	GR4	GR5	GR6	GR7	GR8	GR9	GR10	LEA
\$1312	\$1380	\$1436	\$1503	\$1569	\$1637	\$1716	\$1796	\$1876	\$1983	\$2089	\$2423

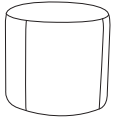

**8341-NL 18" Round Ottoman / No Legs**

COM Yardage: Total: 2.75 Yds. / Sides: 2 Yds. / Top: .75 Yds.

COM	GR1	GR2	GR3	GR4	GR5	GR6	GR7	GR8	GR9	GR10	LEA
\$1319	\$1499	\$1676	\$1857	\$2040	\$2216	\$2396	\$2574	\$2756	\$2936	\$3115	\$3286

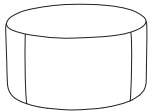

**8339-NL 24" Round Ottoman / No Legs**

COM Yardage: Total: 2.75 Yds. / Sides: 2 Yds. / Top: .75 Yds.

COM	GR1	GR2	GR3	GR4	GR5	GR6	GR7	GR8	GR9	GR10	LEA
\$1618	\$1811	\$1999	\$2190	\$2383	\$2571	\$2760	\$2950	\$3142	\$3332	\$3524	\$3707

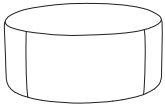

**8340-NL 30" Round Ottoman / No Legs**

COM Yardage: Total: 3.5 Yds. / Sides: 2.5 Yds. / Top: 1 Yds.

COM	GR1	GR2	GR3	GR4	GR5	GR6	GR7	GR8	GR9	GR10	LEA
\$2192	\$2385	\$2572	\$2762	\$2958	\$3145	\$3336	\$3525	\$3717	\$3908	\$4096	\$4278

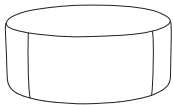

**8342-NL 36" Round Ottoman / No Legs**

COM Yardage: Total: 3.75 Yds. / Sides: 2.5 Yds. / Top: 1.25 Yds.

COM	GR1	GR2	GR3	GR4	GR5	GR6	GR7	GR8	GR9	GR10	LEA
\$2606	\$2796	\$2987	\$3179	\$3366	\$3558	\$3747	\$3938	\$4130	\$4318	\$4507	\$4688

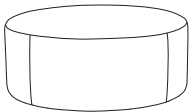

**8344-NL 42" Round Ottoman / No Legs**

COM Yardage: Total: 4.25 Yds. / Sides: 2.75 Yds. / Top: 1.5 Yds.

COM	GR1	GR2	GR3	GR4	GR5	GR6	GR7	GR8	GR9	GR10	LEA
\$2827	\$3017	\$3208	\$3400	\$3589	\$3782	\$3971	\$4159	\$4350	\$4541	\$4732	\$4913

**OPTIONS**

Add upcharge to list price and code to model number

FR	CAL 133 (TB 133) Fire Retardant per yard	\$123	/yd.
MB	Moisture Barrier (1"-59"width)	\$171	ea.

2FO	Two Fabric Option	\$136	
-----	-------------------	-------	--

DIMENSIONS	27" Square	36" Square	42" Square
Overall Depth:	27"	36"	42"
Overall Width:	27"	36"	42"
Overall Height:	18"	18"	18"
Qty./Wt.:	1 ea./50 lbs.	1 ea./58 lbs.	1 ea./78 lbs.



27" SQUARE WITH CASTERS  
AND FIXED TABLET ARMS



36" SQUARE OTTOMAN

**MODEL / DESCRIPTION / LIST PRICING**

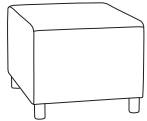

**8346** 27" Square Ottoman

COM Yardage: Total: 3 Yds. / Sides: 2 Yds. / Top: 1 Yds.

COM	GR1	GR2	GR3	GR4	GR5	GR6	GR7	GR8	GR9	GR10	LEA
\$1649	\$1853	\$2059	\$2260	\$2465	\$2671	\$2877	\$3079	\$3284	\$3487	\$3691	\$3888

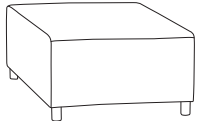

**8348** 36" Square Ottoman

COM Yardage: Total: 3.75 Yds. / Sides: 2.5 Yds. / Top: 1.25 Yds.

COM	GR1	GR2	GR3	GR4	GR5	GR6	GR7	GR8	GR9	GR10	LEA
\$2672	\$2891	\$3108	\$3324	\$3539	\$3756	\$3974	\$4188	\$4404	\$4620	\$4838	\$5046

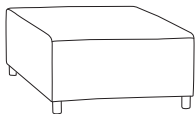

**8350** 42" Square Ottoman

COM Yardage: Total: 4.25 Yds. / Sides: 2.75 Yds. / Top: 1.5 Yds.

COM	GR1	GR2	GR3	GR4	GR5	GR6	GR7	GR8	GR9	GR10	LEA
\$3123	\$3340	\$3556	\$3771	\$3986	\$4205	\$4423	\$4637	\$4855	\$5071	\$5286	\$5493

**OPTIONS**

Add upcharge to list price and code to model number

FR	CAL 133 (TB 133) Fire Retardant per yard	\$123	/yd.
MB	Moisture Barrier (1"-59"width)	\$171	ea.
WOD	Solid Maple Wood Legs	\$33	ea.
PC	Polished Chrome Legs	\$35	ea.
CAS3	3" Locking Casters	\$35	ea.
2FO	Two Fabric Option	\$136	per unit

GD1	Ratchet Ganging Device for Soft Seating	\$116	per pair
GD2	Flat Ganging Device for Soft Seating	\$116	per pair
TABFB-(L)	Fixed Blade Tablet (outside or inside, specify (L/R), shape A, B or C)	\$617	ea. tablet
LAM5	Non-standard laminate (5 tablets or less)	\$576	ea. tablet
SST	Solid Surface Tablet Arm - add to tablet option	\$282	ea. tablet
SS5	Non-standard Solid Surface (5 tablets or less)	Call For Quote	

DIMENSIONS	Straight Benches
Overall Depth:	20"
Overall Width:	22, 44, 66"
Overall Height:	18"
Qty./Wt.:	1 ea./45/60/78 lbs.



THREE SEAT STRAIGHT BENCH

**MODEL / DESCRIPTION / LIST PRICING**

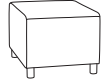

**8352** Single Seat Straight Bench

COM Yardage: Total: 2.25 Yds. / Sides: 1.5 Yds. / Top: .75 Yds.

COM	GR1	GR2	GR3	GR4	GR5	GR6	GR7	GR8	GR9	GR10	LEA
\$1381	\$1502	\$1619	\$1753	\$1875	\$2010	\$2147	\$2282	\$2418	\$2555	\$2690	\$2885



**8354** Two Seat Straight Bench

COM Yardage: Total: 3.25 Yds. / Sides: 1.75 Yds. / Top: 1.5 Yds.

COM	GR1	GR2	GR3	GR4	GR5	GR6	GR7	GR8	GR9	GR10	LEA
\$2567	\$2782	\$2999	\$3214	\$3430	\$3648	\$3864	\$4079	\$4295	\$4516	\$4730	\$4936



**8356** Three Seat Straight Bench

COM Yardage: Total: 4.5 Yds. / Sides: 2.5 Yds. / Top: 2 Yds.

COM	GR1	GR2	GR3	GR4	GR5	GR6	GR7	GR8	GR9	GR10	LEA
\$3016	\$3233	\$3450	\$3667	\$3881	\$4098	\$4315	\$4532	\$4749	\$4962	\$5180	\$5388

**OPTIONS**

Add upcharge to list price and code to model number

FR	CAL 133 (TB 133) Fire Retardant per yard	\$123	/yd.	GD1	Ratchet Ganging Device for Soft Seating	\$116	per pair
MB	Moisture Barrier (1"-59"width)	\$171	ea.	GD2	Flat Ganging Device for Soft Seating	\$116	per pair
MB60	Moisture Barrier (60"and up)	\$272	ea.	TABFB- ( )	Fixed Blade Tablet (outside or inside, specify (L/R), shape A, B or C)	\$617	ea. tablet
WOD	Solid Maple Wood Legs	\$33	ea.	LAM5	Non-standard laminate (5 tablets or less)	\$576	ea. tablet
PC	Polished Chrome Legs	\$35	ea.	SST	Solid Surface Tablet Arm - add to tablet option	\$282	ea. tablet
CAS3	3" Locking Casters - Black	\$35	ea.	SS5	Non-standard Solid Surface (5 tablets or less)	Call For Quote	
2FO	Two Fabric Option	\$136	per unit				

**OPTIONS**

- CODE: FR - CAL 133 (TB 133) Fire Retardant
- CODE: MB - Moisture Barrier (1"-59"width)
- CODE: LOW - Fully Upholstered Low Back - 27" OA Height
- CODE: WOD - Solid Maple Wood Legs with felt pads
- CODE: PC - Polished Chrome Legs
- CODE: CAS3 - 3" Locking Casters - Black
- CODE: 2FO - Two Fabric Option
- CODE: WAC - Wood Arm Caps
- CODE: PAC - Poly Arm Caps - Standard Black/Charcoal
- CODE: 3FO - Three Fabric Option
- CODE: GD1 - Ratchet Ganging Device for Soft Seating
- CODE: GD2 - Flat Ganging Device for Soft Seating

- CODE: GD3 - Flat Ganging Device for Café & Training Tables
- CODE: TAB-(\_) - Non-Removable Swivel Tablet  
(laminat shape A, B or C left or right arm)
- CODE: TABR1-(\_) - Removable Swivel Tablet  
(laminat shape A, B or C specify left or right arm)
- CODE: TABR2-(\_) - Removable Swivel Tablet  
(laminat shape A, B or C with opening for tablet on both arms)
- CODE: LAM5 - Non-standard laminate for 5 or less tablets  
see options for upcharge
- CODE: SST - Solid Surface Tablet Arm - add to tablet option.
- CODE: SS5 - Non-standard Solid Surface top for 5 or less tablets
- CODE: CO - Clean Out (1"-59"width)
- CODE: CO1 - Clean Out (60"and up)

**Note:**

- Tablet orders of 5 or less - choice of 4 standard laminate colors:  
Wilsonart Black 1595-60, Formica Brite White 459-58,  
Wilsonart Montana Walnut 7110K-78 or  
Nevamar Silver Alu Metalx MXT003.
- Tablet orders of 6 or more - any choice standard laminate colors.

Note: Factory installed power/data available, see accessories online under the 'Products' tab.



RAVEN LOUNGE



RAVEN TWO SEAT LOUNGE



LOW-BACK



3" LOCKING CASTERS

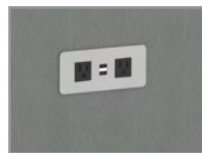

ELECTRICAL/DATA

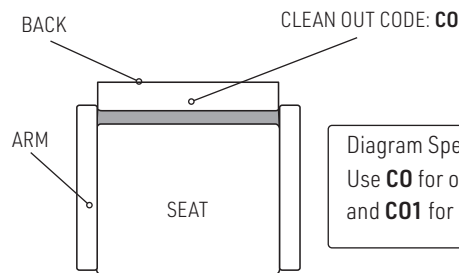

Diagram Specifies A Clean Out  
Use **CO** for overall widths up to 50"  
and **CO1** for overall widths over 50"

Note: Factory installed power/data available, see accessories online under the 'Products' tab.

**TABLET SHAPES**

**Three Tablet Shapes::**

Choose from the three shapes shown and specify; A, B or C and left or right (outside tablet) when ordering.  
Example: TABF-(A) Left - this would be a fixed shape A tablet on the left side (when seated).

**Laminate Top: Tops are 3/4"**

- Tablet orders of 5 or less have 4 standard laminate colors:
- Wilsonart Black 1595-60
  - Formica Brite White 459-58
  - Wilsonart Montana Walnut 7110K-78
  - Nevamar Silver Alu Metalx MXT003
- Edge: 6F Multi-Ply

**Solid Surface Top:**

- Tablet orders of 5 or less have 4 standard Corian colors:
- Bone
  - Canyon
  - Glacier White
  - Silver Grey

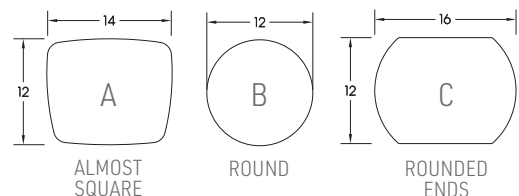

**Note:** Tablets can not be used with Arm Caps.

DIMENSIONS	Single Seat Lounge	Two Seat Lounge
Seat Depth:	20"	20"
Seat Height:	18"	18"
Arm Height:	25"	25"
Overall Depth:	27"	27"
Overall Width:	27"	49"
Overall Height:	33"	33"
Qty./Wt.:	1 ea./65 lbs.	1 ea./105 lbs.



RAVEN SINGLE LOUNGE WITH  
OPTIONAL LOW BACK

**MODEL / DESCRIPTION / LIST PRICING**



**8403** Single Seat Lounge

COM Yardage: Total: 7 Yds. / Back: 2 Yds. / Seat: 2 Yds./ Arms(2) 3 Yds.

COM	GR1	GR2	GR3	GR4	GR5	GR6	GR7	GR8	GR9	GR10	LEA
\$2567	\$2839	\$3069	\$3357	\$3594	\$3846	\$4099	\$4350	\$4638	\$4928	\$5217	\$5747

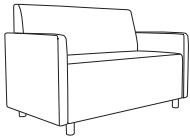

**8401** Two Seat Lounge

COM Yardage: Total: 10 Yds. / Back: 4 Yds. / Seat: 3 Yds. / Arms(2) 3 Yds.

COM	GR1	GR2	GR3	GR4	GR5	GR6	GR7	GR8	GR9	GR10	LEA
\$3747	\$4110	\$4432	\$4796	\$5119	\$5443	\$5769	\$6092	\$6454	\$6815	\$7176	\$7706

**Note:** Clean out option is only available when units are facing the same direction.

**OPTIONS**

Add upcharge to list price and code to model number

FR	CAL 133 (TB 133) Fire Retardant per yard	\$123	/yd.	TAB-( )	Swivel Tablet (specify A, B or C, left or right arm)	\$679	ea. tablet
MB	Moisture Barrier (1"-59"width)	\$171	ea.	TABR1-( )	Removable Tablet (specify A, B or C, left or right arm)	\$786	ea. tablet
LOW	Fully Upholstered Low Back - 27" OA Height	\$129		TABR2-( )	Removable Tablet (specify A, B or C both arm openings)	\$929	ea. tablet
WOD	Solid Maple Wood Legs	\$33	ea.	LAM5	Non-standard laminate (5 tablets or less)	\$576	ea. tablet
PC	Polished Chrome Legs	\$35	ea.	SST	Solid Surface Tablet Arm - add to tablet option	\$282	ea. tablet
PB	Laminate Plinth Base - Straight Unit	\$217		SS5	Non-standard Solid Surface (5 tablets or less)	Call For Quote	
CAS3	3" Locking Casters - Black	\$35	ea.	WAC	Wood Arm Cap	\$121	ea.
2FO	Two Fabric Option	\$136	per unit	PAC	Poly Arm Cap - Standard Black/Charcoal	\$93	ea.
3FO	Three Fabric Option	\$207	per unit	CO	Clean Out (1"-59"width)	\$340	
GD1	Ratchet Ganging Device for Soft Seating	\$116	per pair	CO1	Clean Out (60"and up)	\$523	
GD2	Flat Ganging Device for Soft Seating	\$116	per pair				

**RAVEN JUNIOR COLLECTION**

The Raven Junior Lounge Series offers great creativity and flexibility in children's seating. Designed for children's areas and any public spaces that require durable seating.



60° CURVE UNIT



RAVEN JUNIOR



RAVEN JUNIOR  
MODULAR CONFIGURATION

**ORDERING INFORMATION**

- |                            |                               |
|----------------------------|-------------------------------|
| 1) Series Name             | 5) Powder Coat Color for legs |
| 2) Model Number            | 6) Optional Items             |
| 3) Quantity                |                               |
| 4) Fabric Grade and Number |                               |

**STANDARD BASE FINISHES**

**4 Leg:** Standard Powder Coat

**OPTIONAL BASE FINISHES**

**4 Leg:** Polished Chrome or Standard Wood Finish

**GENERAL SPECIFICATIONS**

**Upholstery / Foam**

Seat and back are covered in choice of fabric, vinyl, crypton, leather or COM. ERG uses only water based glues and adhesives in our upholstery process. All foam is fully bonded to frame. Seat cushions are 4" graded high resiliency (H.R.) block foam with back 3" (H.R.) foam, covered entirely with special bonded polyester fiber to protect final upholstery.

**Frame Construction**

Frame assembly is constructed of multi-ply hardwood, with tongue and groove construction. No sag-springs are installed in seat & back along with interlocking helicoil springs to prevent sagging and provide additional lower back and seat support.

**Base Details**

**4 Leg:** 2"RD X 3"H round tubular steel legs.

**Metal legs** - Poly Vinyl glides

**Wood legs** - with Felt pads

**Casters:** 3" Locking Casters

**OPTIONS**

- CODE: FR - CAL 133 (TB 133) Fire Retardant
- CODE: MB - Moisture Barrier (1"-59"width)
- CODE: WOD - Solid Maple Wood Legs
- CODE: PC - Polished Chrome Legs
- CODE: CAS3 - 3" Locking Casters - Black
- CODE: 2FO - Two Fabric Option
- CODE: GD1 - Ratchet Ganging Device for Soft Seating
- CODE: GD2 - Flat Ganging Device for Soft Seating



DIMENSIONS	Single Unit	Two Seat Unit	Two Seat Backless Unit	Square Ottoman	Round Ottomans
Seat Depth:	17.5"	17.5"	24"	-	-
Seat Height:	16"	16"	16"	-	-
Overall Depth:	24"	24"	24"	24"	18"
Overall Width:	18"	42"	42"	24"	18"
Overall Height:	27.5"	27.5"	16"	16"	16"
Qty./Wt.:	1 ea./35 lbs.	1 ea./60 lbs.	1 ea./55 lbs.	1 ea./40 lbs.	1 ea./26 lbs.



SINGLE UNIT

**MODEL / DESCRIPTION / LIST PRICING**



**8400** Single Unit (4 Legs)

COM Yardage: Total: 3 Yds. / Back: 1.5 Yds. / Seat: 1.5 Yds.

COM	GR1	GR2	GR3	GR4	GR5	GR6	GR7	GR8	GR9	GR10	LEA
\$1489	\$1596	\$1658	\$1725	\$1795	\$1868	\$1943	\$2019	\$2098	\$2185	\$2272	\$2685



**8402** Two Seat Unit (4 legs)

COM Yardage: Total: 4.5 Yds. / Back: 2.5 Yds. / Seat: 2 Yds.

COM	GR1	GR2	GR3	GR4	GR5	GR6	GR7	GR8	GR9	GR10	LEA
\$2374	\$2538	\$2640	\$2746	\$2855	\$2970	\$3088	\$3212	\$3342	\$3476	\$3613	\$4272



**8404** Two Seat Backless Unit (4 legs)

COM Yardage: Total: 3.5 Yds. / Top: 1.5 Yds. / Sides: 2 Yds.

COM	GR1	GR2	GR3	GR4	GR5	GR6	GR7	GR8	GR9	GR10	LEA
\$2043	\$2175	\$2258	\$2338	\$2427	\$2520	\$2616	\$2714	\$2815	\$2924	\$3032	\$3562

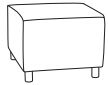

**8406** 24" Square Ottoman - 16" height (4 legs)

COM Yardage: Total: 2.75 Yds. / Top: .75 Yds. / Sides: 1.5 Yds.

COM	GR1	GR2	GR3	GR4	GR5	GR6	GR7	GR8	GR9	GR10	LEA
\$1357	\$1439	\$1493	\$1546	\$1602	\$1659	\$1724	\$1783	\$1850	\$1918	\$1986	\$2325

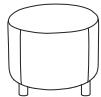

**8341-S** 18" Round Ottoman - 16" height (4 legs)

COM Yardage: Total: 2.75 Yds. / Sides: 2 Yds. / Top: .75 Yds.

COM	GR1	GR2	GR3	GR4	GR5	GR6	GR7	GR8	GR9	GR10	LEA
\$1378	\$1445	\$1499	\$1565	\$1632	\$1698	\$1780	\$1860	\$1940	\$2047	\$2153	\$2486

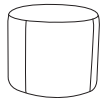

**8341-NLS** 18" Round Ottoman - 16" height / No Legs

COM Yardage: Total: 2.75 Yds. / Sides: 2 Yds. / Top: .75 Yds.

COM	GR1	GR2	GR3	GR4	GR5	GR6	GR7	GR8	GR9	GR10	LEA
\$1312	\$1380	\$1436	\$1503	\$1569	\$1637	\$1716	\$1796	\$1876	\$1983	\$2089	\$2423

**OPTIONS**

Add upcharge to list price and code to model number

FR	CAL 133 (TB 133) Fire Retardant per yard	\$123	/yd.
MB	Moisture Barrier (1"-59"width)	\$171	ea.
2FO	Two Fabric Option	\$136	per unit
GD1	Ratchet Ganging Device for Soft Seating	\$116	per pair

GD2	Flat Ganging Device for Soft Seating	\$116	per pair
PC	Polished Chrome Legs	\$35	ea.
CAS3	3" Locking Casters - Black	\$35	ea.
WOD	Solid Maple Wood Legs	\$33	ea.



DIMENSIONS	30° curve unit (inside / outside)	60° curve unit (inside / outside)	Backless 30° unit	Backless 60° unit
Seat Depth:	17.5"	17.5"	24"	24"
Seat Height:	16"	16"	16"	16"
Overall Depth:	26"	28"	26"	28"
Overall Width:	24.5"	47"	24.5"	47"
Overall Height:	27.5"	27.5"	16"	16"
Qty./Wt.:	1 ea./62 lbs.	1 ea./110 lbs.	1 ea./35 lbs.	1 ea./55 lbs.



60° CURVE UNIT

### MODEL / DESCRIPTION / LIST PRICING



**8408** 30° inside curve unit (4 Legs)

COM Yardage: Total: 4 Yds. / Back: 2 Yds. / Seat: 2 Yds.

COM	GR1	GR2	GR3	GR4	GR5	GR6	GR7	GR8	GR9	GR10	LEA
\$1520	\$1613	\$1690	\$1757	\$1823	\$1890	\$1971	\$2051	\$2130	\$2239	\$2345	\$2677



**8410** 30° outside curve unit (4 Legs)

COM Yardage: Total: 4.5 Yds. / Back: 2 Yds. / Seat: 2.5 Yds.

COM	GR1	GR2	GR3	GR4	GR5	GR6	GR7	GR8	GR9	GR10	LEA
\$1671	\$1775	\$1860	\$1933	\$2006	\$2080	\$2168	\$2256	\$2345	\$2462	\$2579	\$2945

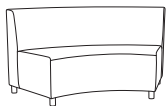

**8412** 60° inside curve unit (5 Legs)

COM Yardage: Total: 6.5 Yds. / Back: 4 Yds. / Seat: 2.5 Yds.

COM	GR1	GR2	GR3	GR4	GR5	GR6	GR7	GR8	GR9	GR10	LEA
\$2559	\$2740	\$2849	\$2962	\$3080	\$3204	\$3332	\$3468	\$3606	\$3747	\$3900	\$4610

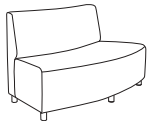

**8414** 60° outside curve unit (5 Legs)

COM Yardage: Total: 7 Yds. / Back: 3 Yds. / Seat: 4 Yds.

COM	GR1	GR2	GR3	GR4	GR5	GR6	GR7	GR8	GR9	GR10	LEA
\$2779	\$2959	\$3067	\$3181	\$3299	\$3423	\$3552	\$3686	\$3823	\$3967	\$4120	\$4829

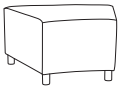

**8416** Backless 30° unit (4 Legs)

COM Yardage: Total: 3 Yds. / Top: 1 Yds. / Sides: 2 Yds.

COM	GR1	GR2	GR3	GR4	GR5	GR6	GR7	GR8	GR9	GR10	LEA
\$1370	\$1465	\$1524	\$1585	\$1649	\$1715	\$1780	\$1852	\$1927	\$2005	\$2086	\$2463



**8418** Backless 60° unit (5 Legs)

COM Yardage: Total: 4.75 Yds. / Top: 2 Yds. / Sides: 2.75 Yds.

COM	GR1	GR2	GR3	GR4	GR5	GR6	GR7	GR8	GR9	GR10	LEA
\$2156	\$2308	\$2402	\$2497	\$2596	\$2699	\$2808	\$2920	\$3036	\$3156	\$3281	\$3882

### OPTIONS

Add upcharge to list price and code to model number

FR	CAL 133 (TB 133) Fire Retardant per yard	\$123	/yd.
MB	Moisture Barrier (1"-59"width)	\$171	ea.
2FO	Two Fabric Option	\$136	per unit
GD1	Ratchet Ganging Device for Soft Seating	\$116	per pair

GD2	Flat Ganging Device for Soft Seating	\$116	per pair
PC	Polished Chrome Legs	\$35	ea.
CAS3	3" Locking Casters - Black	\$35	ea.
WOD	Solid Maple Wood Legs	\$33	ea.